

# Current Transformer

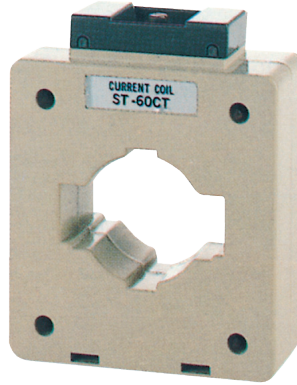

**ST-100CT**



**ST-60CT**

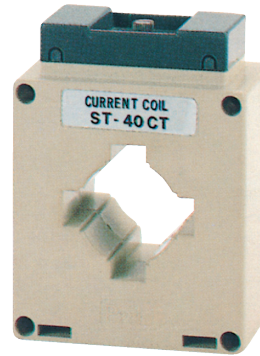

**ST-40CT**



**ST-30CT**

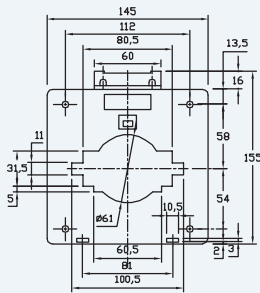

**1000/5A-3000/5A**  
**10-15V A**  
**Class 1**  
**Insulation 600V**

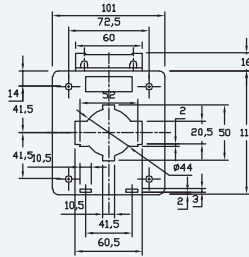

**400/5A-800/5A**  
**7.5-10V A**  
**Class 1**  
**Insulation 600V**

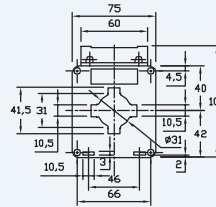

**200/5A-400/5A**  
**3-5V A**  
**Class 1**  
**Insulation 600V**

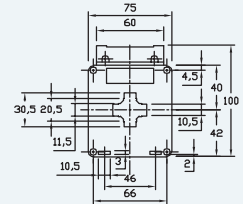

**30/5A-150/5A**  
**2-3V A**  
**Class 1**  
**Insulation 600V**



**ST-30RCT**



**ST-12RCT**



**ST-9RCT**

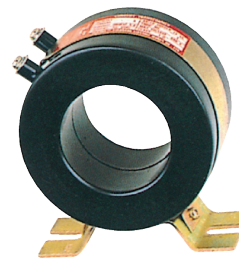

**ST-6RCT**

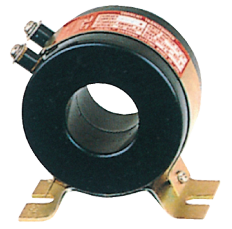

**ST-3RCT**

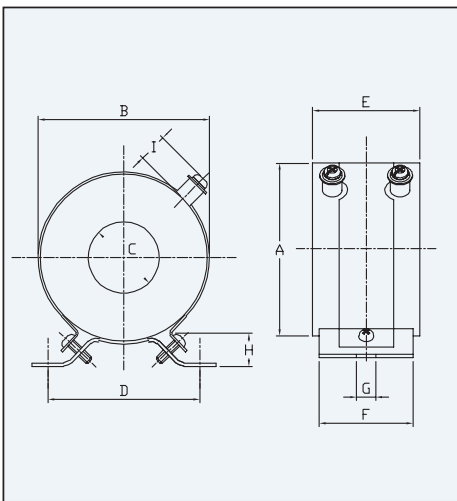

Model	Primary Current Rating (Amp)	Sec. Current(A)	Burden (VA)	Accuracy	Power Strength	Weight
ST-3RCT	20~300	5	15	1.0	40	0.8
ST-6RCT	400~600	5	15	1.0	40	1
ST-9RCT	800~1200	5	15	1.0	40	1.2
ST-12RCT	800~2000	5	15	1.0	40	1.3
ST-30RCT	1600~4000	5	15	1.0	40	2

Model	A	B	C	D	E	F	G	H	I
ST-3RCT	95	80	35	80	55	45	9	20	13
ST-6RCT	120	100	55	80	55	45	9	20	13
ST-9RCT	150	135	90	80	55	45	9	20	13
ST-12RCT	170	150	110	80	55	45	9	20	13
ST-30RCT	200	180	125	80	60	45	9	20	13