

HIOKI

New

DIGITAL MULTIMETER DT4200 Series

DMM / Testers



Super Fast Response Rate and Safety Features
Take Professional Testing to a Higher Level

Made in Japan for rock-solid quality.





Hazard 1 Prevent unavoidable debris from shorting the measurement target and causing an accident.



The DT4255's voltage input terminals incorporate a protective fuse so that contamination of the instrument's internal components with iron powder or other particulate matter will not result in an internal short-circuit. The fuse can be replaced easily on site.

Hazard 2 Continued high input may result in major accidents such as fire.



To prevent an accident, a warning function immediately notifies the operator if the DMM receives excessively high input.

*Red screen available on high-end models only.

Hazard 3 Wrong insertion may lead to short-circuits.



A range: Only the A and COM terminal inlets open.
V range: Only the V and COM terminal inlets open.

The DT4281 and DT4282 use terminal shutters to keep probes from being inserted into the wrong inlets. The shutters block whichever terminal is not being used based on the selected measurement function.

Hazard 4 Mistakenly measuring voltage using the current range may lead to a short-circuit.



The DT4281, DT4253, DT4255, and DT4256 eliminate the root cause of such accidents by providing clamp-on sensor-based current measurement functionality instead of using conventional probes.



Safe testers that protect workers from dangerous accidents

Engineered based on extensive customer feedback, the Hioki Digital Multimeter DT4200 series delivers the design and quality needed in order to ensure safety in field measurement.

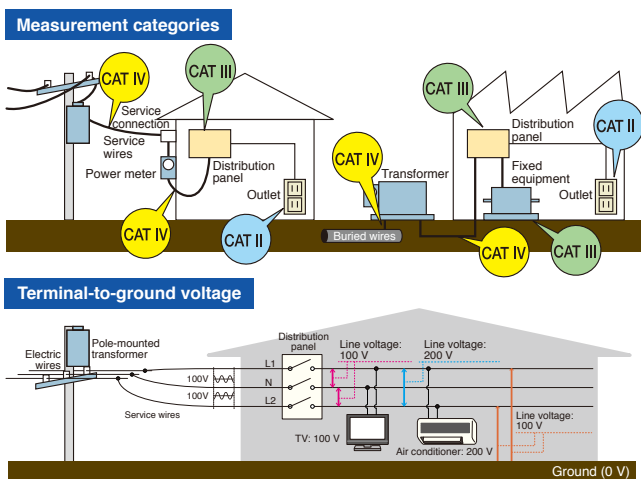

Safe measurement requires use of an instrument that suits the measurement location.

To ensure operators' ability to use measuring instruments safely, IEC 61010 classifies the locations in which instruments are used into a series of safety-based measurement categories (ranging from CAT II to CAT IV). Using an instrument that does not satisfy the required safety level can lead to an electrical accident.

CAT IV 600 V Terminal-to-ground voltage
Measurement category suited to the location of use

| | |
|-----------------|-------------------------------|
| High-end models | CAT III 1000 V / CAT IV 600 V |
| Standard models | CAT III 1000 V / CAT IV 600 V |
| Pocket models | CAT III 600 V / CAT IV 300 V |



Designed and manufactured in Japan to ensure high quality and guaranteed with a 3-year warranty for peace of mind

All development, design, and manufacturing processes for almost all Hioki digital multimeters are carried out at our Head Office in Nagano Prefecture. Some of the industry's most advanced technological capabilities enable us to deliver products of the highest possible quality.





Field-Proven Strength and Usability

DT4200 series

Robust design capable of withstanding a drop from a height of 1 m onto concrete



Drop tester

To test our products' ability to withstand mechanical shock, we repeatedly drop them from a height of at least 1 m until they break. This drop-testing regime leads to more robust products by fostering a series of design improvements.



Preventing instrument failure by keeping out dust



If dust gets into the instrument's enclosure, it can cause the device to fail. Since dust can get into the instrument especially easily through the gap around the rotary switch, the DT4200 series incorporates a dust-proof part known as an O-ring where the rotary switch is mounted to improve the device's dust resistance.

Fast, accurate measurement of the output voltage on the secondary side of an inverter

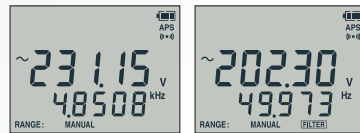

With low-pass filter off With low-pass filter on

The DT series can accurately measure the voltage on the secondary side of an inverter, just like a power meter. Its low-pass filter rejects harmonic components so that the fundamental wave can be isolated and accurately measured.

True RMS measurement for accurate measurement of even distorted current waveforms

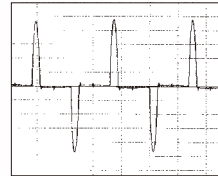

Average-value method measured value



True RMS method measured value

Current waveforms are often distorted, causing the average-value and true RMS measurement methods to yield different results. To obtain accurate readings, RMS measurement is indispensable.

Outstanding viewing angle so display is easy to read at an angle or even in a dim location



The DT4200 series features a display with a wide viewing angle and a backlight function so that it's easy to read, even when you can't view the screen from the front or when making measurements in a dim location.

Rotary switch that's easy to operate even when wearing gloves



The DT4200's rotary switch is designed to be easy to turn even when wearing thick work gloves, for example while working in hazardous measurement locations or harsh conditions.

Outstanding hands-free ease of use in the field when working with numerous measurement locations

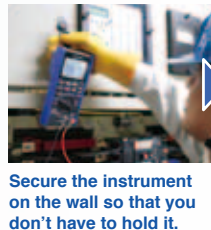

Secure the instrument on the wall so that you don't have to hold it.



The display automatically stops once the measured value stabilizes.



Press the MEM key to save measured values in the instrument's internal memory.

It's hard to carry out work tasks smoothly when you're juggling a measuring instrument, probes, recording paper, and other supplies. Field concerns like these are resolved by the DT4200's magnetic strap, auto-hold function, and ability to save results in its internal memory. These capabilities boost work efficiency and help reduce work times.

*The auto-hold function is available exclusively in high-end and standard models. The ability to save results in internal memory is available exclusively in high-end models.

Extensive selection of probe tips that you can choose based on the measurement location, improving ease of measurement



With screw terminals



In deep-set locations that can't be reached with other probes



For clamping around the target busbar

With the DT4200, you can choose the probe type that best suits your measurement location, making it possible to measure in areas that can't be reached with conventional probes and busbars that you wish to clamp between probes.

*Compatible probe tips vary with the DMM model. Please see page 16. The optional Connection Cable L4930 is required in order to use the probes shown at the left.



High-end models

Featuring high accuracy, extensive additional functionality, and a broad range of measurement parameters

DCV typical accuracy: $\pm 0.025\%$ rdg. ± 2 dgt.

Measurement categories: CAT III (1000 V) / CAT IV (600 V)



For electrical work in the field

DT4281

Designed for maximum safety in the field when measuring current with clamp-on sensors.

| | |
|---------------------------|-----------------------------|
| DC voltage | 60.000 mV to 1000.0 V |
| AC voltage | 60.000 mV to 1000.0 V |
| DC + AC voltage | 6.000 V to 1000.0 V |
| DC current | 600.00 μ A to 600.00 mA |
| AC current | 600.00 μ A to 600.00 mA |
| AC clamp-on measurement | Frequency |
| Resistance | Continuity check |
| Temperature | Diode test |
| Capacitance | Conductance |
| AC/DC automatic detection | Voltage detection function |



For laboratory and research use

DT4282

Designed for use in laboratories and R&D applications where you wish to measure a wide variety of parameters.

| | |
|---------------------------|----------------------------|
| DC voltage | 60.000 mV to 1000.0 V |
| AC voltage | 60.000 mV to 1000.0 V |
| DC + AC voltage | 6.000 V to 1000.0 V |
| DC current | 600.00 μ A to 10.000 A |
| AC current | 600.00 μ A to 10.000 A |
| AC clamp-on measurement | Frequency |
| Resistance | Continuity check |
| Temperature | Diode test |
| Capacitance | Conductance |
| AC/DC automatic detection | Voltage detection function |

● Supported measurement parameter ● Supported measurement parameter (with model-specific variations) ● Unsupported measurement parameter

*The range figures given indicate the instrument's measurement ranges (not the range of measurable values).

Applications



Magnetic strap frees both hands for work

Using the magnetic strap (option)

By using the magnetic strap to secure the instrument to the wall, you can free both hands so that you can more easily record measured values, significantly boosting work efficiency.



Automatically hold display values and save results with one touch to the DMM's internal memory

The display is automatically held once the measured value stabilizes. You can save measurement results to the instrument's internal memory simply by pressing the MEM key, making it easy to read and record values during inspection work.



Manage measurement data on a computer

Using the Communication Package DT4900-01 (option)

Measurement results can be downloaded to a computer via a USB connection. Once downloaded, you can save them as a file (text format) or display them as a graph using the desired interval. Results can also be sent in real time while measurement is ongoing.

*The computer and multimeter are electrically isolated by means of optical communications so that data can be sent with peace of mind.



Measure output voltage on the secondary sides of inverters

Accurately measure the fundamental wave alone by eliminating harmonic components with the DMM's low-pass filter function.

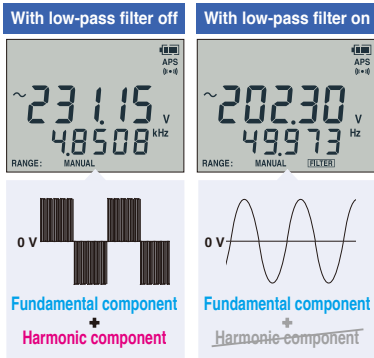

Ripple voltage confirmation of DC charging systems

Peak value measurement / DC + AC voltage measurement

High-end models can detect ripple voltage with a superposed DC signal.

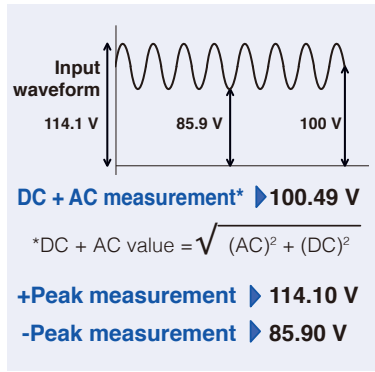

Percentage display for instrumentation signal measurement

4 to 20 mA / 0 to 20 mA percentage-equivalent display

You can check percentage-equivalent values.

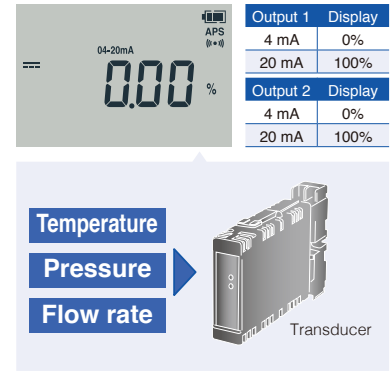

Measure very low currents used by gas-burning devices

DC μ A range

High-end models provide a DC 600.00 μ A range for measuring burner flame currents.

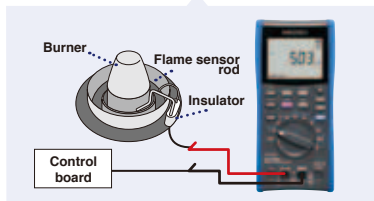

Intuitive notification of continuity check results and excessively high input with a red screen backlight and beep

High-end models notify the operator of continuity check results and excessively high input with a red screen backlight and beep, making it possible to check measurement results intuitively.

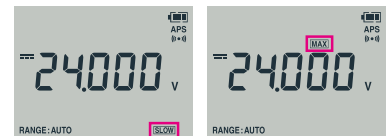

Display refresh rate

Change the display refresh speed to stabilize the display when performing measurement characterized by a high level of variability.

Maximum/minimum value display

Check the maximum and minimum measured values shown on the display after pressing the MAX/MIN button.

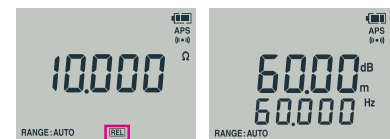

Relative display

View relative values using the display value before the relative function was enabled as the reference.

Decibel conversion

Convert the results of AC voltage measurement to a decibel value relative to a reference value and display the results (dbm/dbv).

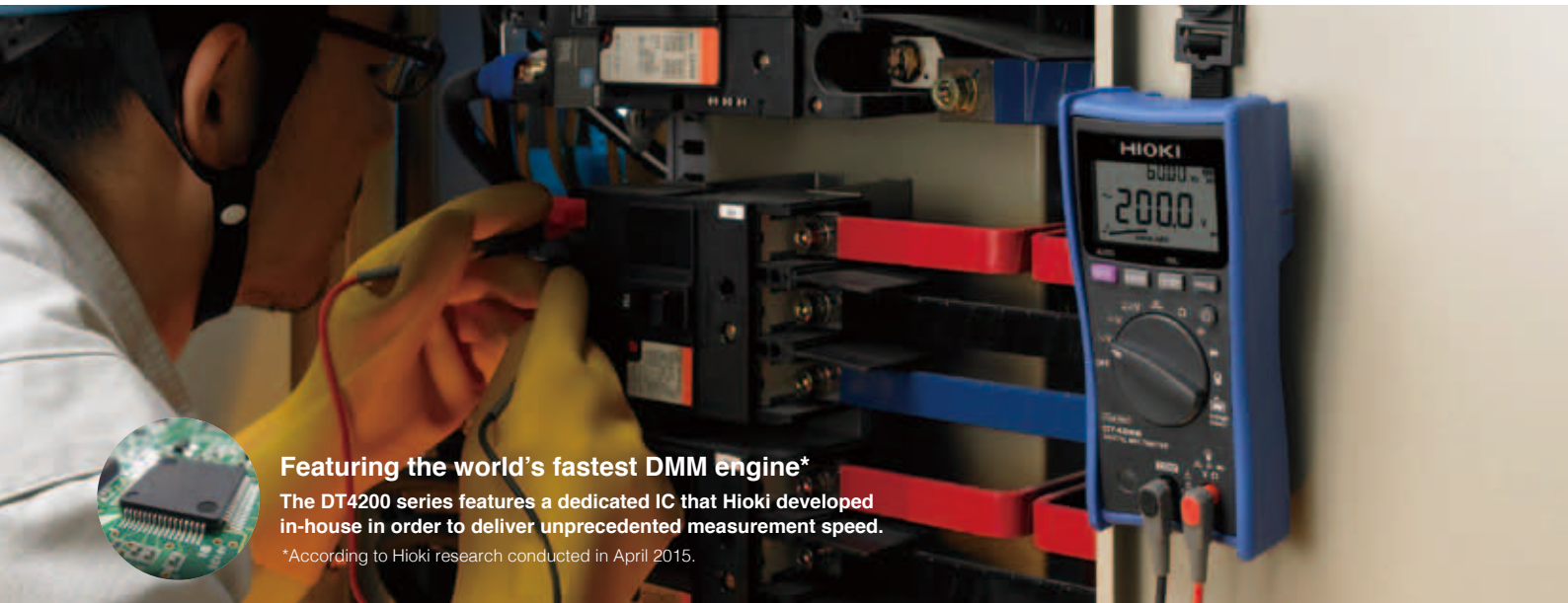

Featuring the world's fastest DMM engine*
 The DT4200 series features a dedicated IC that Hioki developed in-house in order to deliver unprecedented measurement speed.

*According to Hioki research conducted in April 2015.

Standard models

Introducing a line of field-optimized instruments that can be chosen based on the application at hand

DCV typical accuracy: $\pm 0.3\%$ rdg. ± 3 dgt.

Measurement categories: CAT III (1000 V) / CAT IV (600 V)



For laboratory and research use

DT4252

For laboratories and R&D applications where you wish to measure a wide variety of parameters.



For instrumentation 4-20mA

DT4253

Measure instrumentation, air-conditioning equipment, and gas-burning devices.



Voltage measurement only model

DT4254

Measure photovoltaic modules and other high-voltage targets at up to 1700 V DC.



For electrical work in the field

DT4255

Designed for maximum safety with voltage measurement terminals that are protected by a fuse.



Multifunction model

DT4256

Delivers maximum functionality for use in a wide range of settings.

| | |
|---------------------------|----------------------------|
| DC voltage | 600.0 mV to 1000 V |
| AC voltage | 6.000 V to 1000 V |
| DC + AC voltage | DT4281/4282 only |
| DC current | 6.000 A to 10.00 A |
| AC current | 6.000 A to 10.00 A |
| AC clamp-on measurement | Frequency |
| Resistance | Continuity check |
| Temperature | Diode test |
| Capacitance | Conductance |
| AC/DC automatic detection | Voltage detection function |

| | |
|---------------------------|----------------------------|
| DC voltage | 600.0 mV to 1000 V |
| AC voltage | 6.000 V to 1000 V |
| DC + AC voltage | DT4281/4282 only |
| DC current | 60.00 μ A to 60.00 mA |
| AC current | n/a |
| AC clamp-on measurement | Frequency |
| Resistance | Continuity check |
| Temperature | Diode test |
| Capacitance | Conductance |
| AC/DC automatic detection | Voltage detection function |

| | |
|---------------------------|----------------------------|
| DC voltage | 600.0 mV to 1500 V |
| AC voltage | 6.000 V to 1000 V |
| DC + AC voltage | DT4261/4262 only |
| DC current | n/a |
| AC current | n/a |
| AC clamp-on measurement | Frequency |
| Resistance | Continuity check |
| Temperature | Diode test |
| Capacitance | Conductance |
| AC/DC automatic detection | Voltage detection function |

| | |
|---------------------------|----------------------------|
| DC voltage | 600.0 mV to 1000 V |
| AC voltage | 6.000 V to 1000 V |
| DC + AC voltage | DT4261/4262 only |
| DC current | n/a |
| AC current | n/a |
| AC clamp-on measurement | Frequency |
| Resistance | Continuity check |
| Temperature | Diode test |
| Capacitance | Conductance |
| AC/DC automatic detection | Voltage detection function |

| | |
|---------------------------|----------------------------|
| DC voltage | 600.0 mV to 1000 V |
| AC voltage | 6.000 V to 1000 V |
| DC + AC voltage | DT4281/4282 only |
| DC current | 60.00 mA to 10.00 A |
| AC current | 600.0 mA to 10.00 A |
| AC clamp-on measurement | Frequency |
| Resistance | Continuity check |
| Temperature | Diode test |
| Capacitance | Conductance |
| AC/DC automatic detection | Voltage detection function |

● Supported measurement parameter ● Supported measurement parameter (with model-specific variations) ● Unsupported measurement parameter

*The range figures given indicate the instrument's measurement ranges (not the range of measurable values).

Applications



Magnetic strap and auto-hold function free up hands for easier work

Using the magnetic strap (option)

By using the magnetic strap to secure the instrument to the wall and the auto-hold function to automatically stop display values, you can free your hands, making it easier to record measured values and significantly boosting work efficiency.



Automatic switching of measurement in locations where AC and DC voltages are mixed

AC/DC voltage automatic detection (DT4253/54/55/56 only)

When making measurements in locations with both AC and DC voltages, automatic switching eliminates the need to operate the rotary switch and helps prevent measurement mistakes.



Use a computer in the field to save and check measured values

With the Communication Package DT4900-01 (option)

Measured values can be displayed in real time on a computer, and displayed values can be saved to a file (text format) or graphed at a user-specified interval.

*The computer and multimeter are electrically isolated by means of optical communications so that data can be sent with peace of mind.



Measure output voltage on the secondary sides of inverters

Accurately measure the fundamental wave by eliminating harmonic components with the DMM's low-pass filter function.

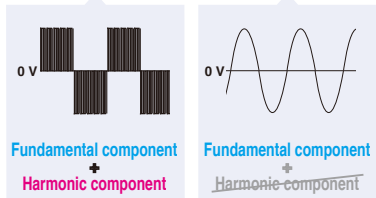
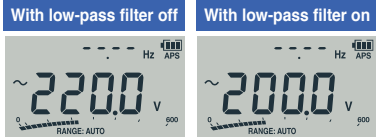

Test no-load voltage at megasolar installations

1700 V DC measurement (DT4254 only)

Model DT4254 can measure DC voltages up to 1700 V, enabling you to make no-load voltage inspections of megasolar installations.



Percentage display for instrumentation signal measurement

4 to 20 mA percentage-equivalent display (DT4253 only)

The standard models' dual display function lets you to simultaneously check measured values and percentage-equivalent values at a glance.

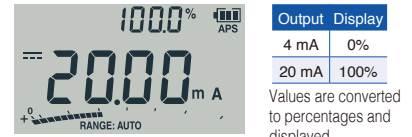

Polarity detection and notification

Certain standard models can detect a load voltage in excess of -10 V and notify the operator with a red LED and beep.

*DT4254/4255/4256 only.

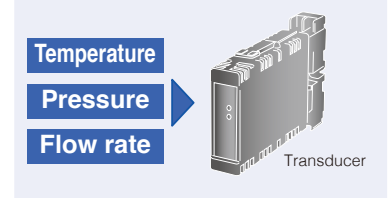

Measure very low currents used by gas-burning devices

DC μ A range (DT4253 only)

Model DT4253 provides a DC 60.00 μ A range for measuring burner flame currents.

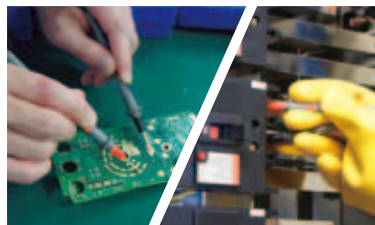
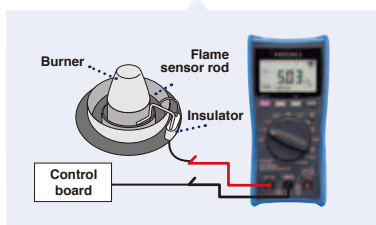

Intuitive notification of continuity check results and excessively high input with a red LED and beep

Standard models notify the operator of continuity check results and excessively high input with a red LED and beep, making it possible to check measurement results intuitively.



Thorough prevention of short-circuit accidents

Voltage measurement terminal fuse (DT4255 only)

When using the resistance measurement function, a protective circuit functions to prevent a short-circuit accident in the event of erroneous operation such as improperly supplying voltage input. Even if a short-circuit occurs inside the tester, a current-limiting resistor will limit any short-circuit current while a fast-blow fuse quickly and reliably disconnects the tester circuitry, preventing a short-circuit accident.

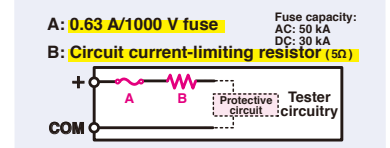

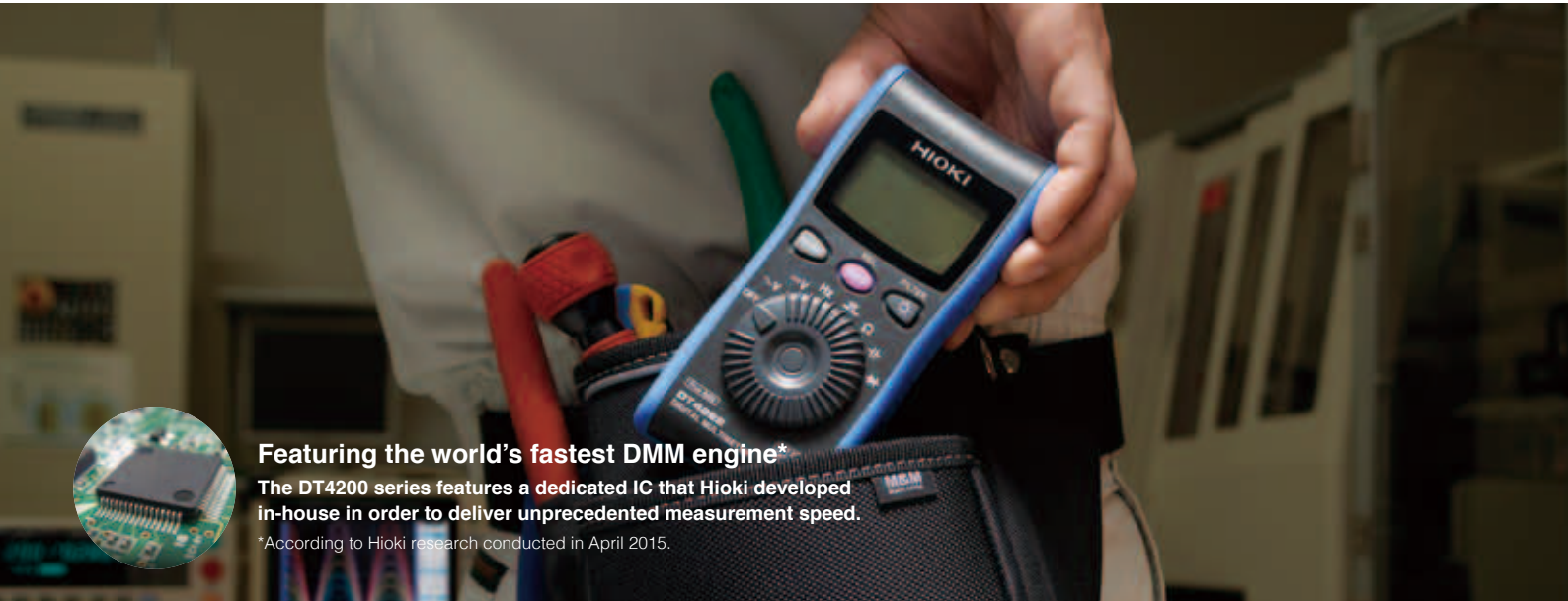

Featuring the world's fastest DMM engine*

The DT4200 series features a dedicated IC that Hioki developed in-house in order to deliver unprecedented measurement speed.

*According to Hioki research conducted in April 2015.

Pocket models

Featuring a compact body for ergonomic hold and a reliable, safe design

DCV typical accuracy: $\pm 0.5\%$ rdg. ± 5 dgt.

Measurement categories: CAT III (600 V) / CAT IV (300 V)



For electrical work in the field

DT4221

Delivering maximum field safety for workers whose principal use is voltage measurement.

| | |
|---------------------------|----------------------------|
| DC voltage | 600.0 mV to 600.0 V |
| AC voltage | 6.000 V to 600.0 V |
| DC + AC voltage | DT4281/4282 only |
| DC current | n/a |
| AC current | n/a |
| AC clamp-on measurement | Frequency |
| Resistance | Continuity check |
| Temperature | Diode test |
| Capacitance | Conductance |
| AC/DC automatic detection | Voltage detection function |



For multiple applications

DT4222

For laboratories and R&D applications to measure a wide variety of parameters.

| | |
|---------------------------|----------------------------|
| DC voltage | 600.0 mV to 600.0 V |
| AC voltage | 6.000 V to 600.0 V |
| DC + AC voltage | DT4281/4282 only |
| DC current | n/a |
| AC current | n/a |
| AC clamp-on measurement | Frequency |
| Resistance | Continuity check |
| Temperature | Diode test |
| Capacitance | Conductance |
| AC/DC automatic detection | Voltage detection function |

● Supported measurement parameter ● Supported measurement parameter (with model-specific variations) ● Unsupported measurement parameter

*The range figures given indicate the instrument's measurement ranges (not the range of measurable values).

Applications



Compact and lightweight design for outstanding ease of use

The small form factor fits in your hand perfectly and is easily stowable, making it convenient to transport to and from the field and boosting work efficiency. The lightweight design also ensures that pocket models are easy to work with.



Single AAA alkaline battery

Since the pocket models only use a single AAA alkaline battery that can be easily replaced, there's no need to carry a large number of spare batteries with you.

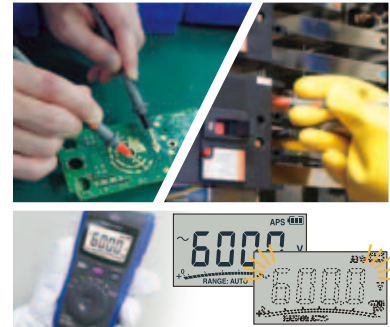

Intuitive notification of excessively high input with flashing screen

The pocket digital multimeters notify the operator of excessively high input by flashing the screen, making it possible to check measurement results intuitively.



Rear probe connections for superior screen visibility and easy storage

Since this design keeps cords from covering up the screen during measurement, you can read values at a glance. After use, probes can be stored on the rear of the instrument, facilitating a smooth start to the next measurement job.

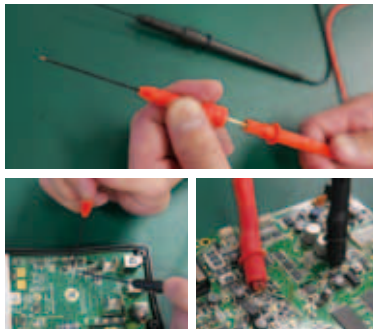

Switchable probe tips for different measurement locations

Probe tips can be switched to accommodate different measurement locations. This feature makes it easy to measure in areas that would otherwise be difficult or impossible to probe.



Safe enough for measuring voltage at distribution panels and service wires

Despite a compact body, the pocket models can be used to measure voltage at distribution panels and service wires in CAT III (600 V)/CAT IV (300 V) situations.

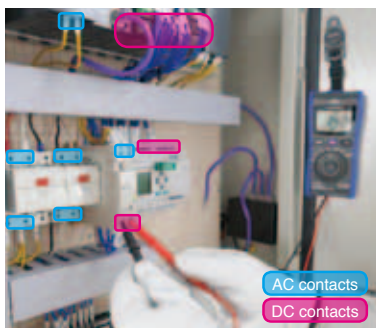

Automatic switching of measurement in locations where AC and DC voltages are mixed

AC/DC voltage automatic detection (DT4221 only)

When making measurements in locations with both AC and DC voltages, automatic switching eliminates the need to operate the rotary switch and helps prevent measurement mistakes.

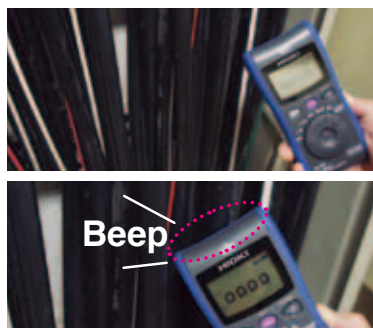

Detect voltage simply by holding the instrument against a wire

Voltage detection function (DT4221 only)

Easily detect voltage with the built-in sensor. Results are communicated with a beep.

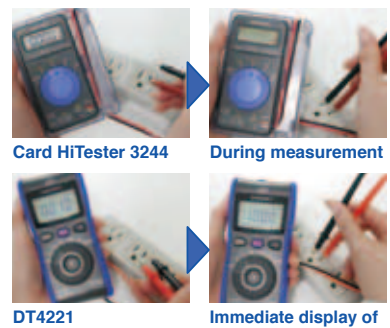

Card HiTester 3244

During measurement

DT4221

Immediate display of measurement results

Fast measurement for outstanding ease of use

Measured values are displayed quickly to facilitate quick testing. The difference is clear when you compare the measurement speed with that of the Hioki Card HITESTER 3244-60.

DT4200 Series Basic Comparison



| Basic Characteristics | | | | | | | | | | | |
|--|---|----------------|--|---|----------------|-----|--------------------|----------------------------|----------------|---|----------------|
| True RMS | Yes | | | Yes | | | Yes | | | | |
| DCV basic accuracy | ±0.025 %rdg. ±2 dgt. | | | ±0.3 %rdg. ±5 dgt. | | | ±0.3 %rdg. ±3 dgt. | | | ±0.5 %rdg. ±5 dgt. | |
| Measurement items (Typical ranges are indicated; may not reflect maximum or minimum measurable signal) | | | | | | | | | | | |
| DC voltage | 60 mV to 1000 V | | | 600 mV to 1000 V | | | 600 mV to 1500 V | 600 mV to 1000 V | | 600 mV to 600 V | |
| AC voltage | 60 mV to 1000 V | | | 6 V to 1000 V | | | | | | 6 V to 600 V | |
| DCV + ACV | 6 V to 1000 V | | | n/a | | | | | | n/a | |
| DCA current | 600 µA to 600 mA | 600 µA to 10 A | | 6 A to 10 A | 60 µA to 60 mA | | n/a | | 60 mA to 10 A | n/a | |
| ACA current | 600 µA to 600 mA | 600 µA to 10 A | | 6 A to 10 A | n/a | | | | 600 mA to 10 A | n/a | |
| AC clamp | 10 A to 1000 A | n/a | | n/a | 10 A to 1000 A | n/a | | 10 A to 1000 A | 10 A to 1000 A | n/a | |
| Resistance | 60 Ω to 600 MΩ | | | 600 Ω to 60 MΩ | | | n/a | | 600 Ω to 60 MΩ | n/a | 600 Ω to 60 MΩ |
| Temperature | -40°C to 800°C | | | n/a | -40°C to 400°C | | n/a | | | n/a | |
| Capacitance | 1 nF to 100 mF | | | 1 µF to 10 mF | | | n/a | | 1 µF to 10 mF | n/a | 1 µF to 10 mF |
| Frequency | 99 Hz to 500 kHz | | | 99 Hz to 99 kHz | | | | | | 99 Hz to 9.9 kHz | |
| Continuity check | Yes | | | Yes | | n/a | | Yes | | Yes | |
| Diode check | Yes | | | Yes | | n/a | | Yes | | n/a | Yes |
| Conductance | n/a | Yes | | n/a | | | | | | n/a | |
| Voltage detection | n/a | | | n/a | | | Yes | | | Yes | n/a |
| Additional Functions | | | | | | | | | | | |
| AUTO AC/DCV | n/a | | | n/a | Yes | | | | Yes | n/a | |
| Peak measurement | DC/AC | | | n/a | | | | | | n/a | |
| Low-pass filter | Analog filter Cut-off : 630 Hz | | | Digital filter Pass-band : 100Hz/500Hz | | | | | | Digital filter Pass-band : 100Hz/500Hz | |
| Display update setting | Yes | | | n/a | | | | | | n/a | |
| Hold display value | AUTO / MANUAL | | | AUTO / MANUAL | | | | | | MANUAL | |
| Max/Min value display | Yes | | | Yes | | | | | | n/a | |
| Relative display | Yes | | | Yes | | | | | | Yes | |
| Decibel conversion | Yes | | | n/a | | | | | | n/a | |
| Percentage conversion display | Yes | | | n/a | Yes | n/a | | n/a | | n/a | |
| DC voltage polarity check | n/a | | | n/a | | | Yes | | | n/a | |
| Data storage | | | | | | | | | | | |
| Capacity | Max 400 data | | | n/a | | | | | | n/a | |
| USB communication*1 | Yes | | | Yes | | | | | | n/a | |
| Operating time | | | | | | | | | | | |
| Continuous operating time | Approx. 100 hours*2 | | | Approx. 130 hours | | | | Approx. 40 hours | | | |
| Power supply | Alkaline (LR6) battery x4 / Manganese(R6P) battery x4 | | | Alkaline (LR03) battery x4 | | | | Alkaline (LR03) battery x1 | | | |
| Display | | | | | | | | | | | |
| Back light | Yes | | | Yes | | | | | | Yes | |
| Dual display | Yes | | | Yes | | | | | | n/a | |
| Bar graph display | n/a | | | Yes | | | | | | Yes | |
| Safety | | | | | | | | | | | |
| Safety standard categories | CATIII1000 V / CATIV600 V | | | CATIII1000 V / CATIV600 V | | | | CATIII600 V / CATIV300 V | | | |
| Mis-insertion prevention shutters | Yes | | | n/a | | | | | | n/a | |

*1. Requires optional DT4900-01 Communication Package

*2. When using four AA alkaline batteries

Glossary

Auto AC/DCV : Automatically detects and measures AC and DC voltage. | **Peak measurement** : After starting PEAK value measurement, check maximum and minimum instantaneous voltage and current values. | **Low-pass filter** : Cuts high frequency content to provide stable numerical values for measurement. | **Display update setting** : Reduces the display value update rate to stabilize measurements. | **Hold display value** : Manual: press the button to freeze the display. Auto: the display freezes automatically when the measurement value is stable. | **Max/Min value display** : Pressing the MAX/MIN button displays the maximum and minimum displayed measurement values. | **Relative display** : Pressing the REL button displays subsequent measurements as values relative to that displayed when the button was pressed. | **Decibel conversion** : Displays AC voltage measurements converted to decibel values (dbm/dbv) | **Percentage conversion display** : Displays 4 to 20 mA (or 0 to 20 mA) signals converted to 0 to 100% values. For the DT4253, only 4 to 20 mA.

High-End DT4281/DT4282

(Accuracy guaranteed for 1 year, Post-adjustment accuracy guaranteed for 1 year)

| DC Voltage | | |
|------------|----------------------|-------------------------------|
| Range | Accuracy | Input Impedance |
| 60.000 mV | ±0.2 %rdg. ±25 dgt. | 1 GΩ or more //100 pF or less |
| 600.00 mV | ±0.025 %rdg. ±5 dgt. | |
| 6.0000 V | ±0.025 %rdg. ±2 dgt. | 11.0 MΩ±2% //100 pF or less |
| 60.000 V | | 10.3 MΩ±2% //100 pF or less |
| 600.00 V | ±0.03 %rdg. ±2 dgt. | 10.2 MΩ±2% //100 pF or less |
| 1000.0 V | | |

| AC Voltage | | | | | | |
|------------|-------------|-------------|-------------|---------------|----------------|--------------------|
| Range | Accuracy | | | | | |
| | 20 to 45 Hz | 45 to 65 Hz | 65 to 1 kHz | 1 k to 10 kHz | 10 k to 20 kHz | 20 k to 100 kHz |
| 60.000 mV | ±1.3 %rdg. | ±0.4 %rdg. | ±0.6 %rdg. | ±0.9 %rdg. | ±1.5 %rdg. | ±20 %rdg. ±80 dgt. |
| 600.00 mV | ±60 dgt. | ±40 dgt. | ±40 dgt. | ±40 dgt. | ±40 dgt. | ±8 %rdg. ±80 dgt. |
| 6.0000 V | ±1 %rdg. | ±0.2 %rdg. | ±0.3 %rdg. | ±0.4 %rdg. | ±0.7 %rdg. | ±3.5 %rdg. |
| 60.000 V | ±60 dgt. | | | | | |
| 600.00 V | Undefined | ±25 dgt. | ±25 dgt. | ±25 dgt. | ±40 dgt. | ±40 dgt. |
| 1000.0 V | Undefined | Undefined | Undefined | Undefined | Undefined | Undefined |

| DCV + ACV Measurement | | | | | | |
|-----------------------|-------------|-------------|-------------|---------------|----------------|-----------------|
| Range | Accuracy | | | | | |
| | 20 to 45 Hz | 45 to 65 Hz | 65 to 1 kHz | 1 k to 10 kHz | 10 k to 20 kHz | 20 k to 100 kHz |
| 6.0000 V | ±1.2 %rdg. | ±0.3 %rdg. | ±0.4 %rdg. | ±0.4 %rdg. | ±1.5 %rdg. | ±3.5 %rdg. |
| 60.000 V | ±65 dgt. | | | | | |
| 600.00 V | Undefined | ±30 dgt. | ±30 dgt. | ±30 dgt. | ±45 dgt. | ±125 dgt. |
| 1000.0 V | Undefined | Undefined | Undefined | ±0.4 %rdg. | Undefined | Undefined |
| | | | | ±45 dgt. | | |

| | |
|------------------------------|---|
| Input impedance | 1MΩ ± 4 %//100pF or less |
| Crest factor | 3 or less (1.5 or less for the 1000.0V range) |
| Accuracy specification range | 5% or more of each range With the filter ON, accuracy is defined only for frequencies 100Hz or less. Furthermore, 2% rdg. is added |

| DCA Measurement | | | |
|-----------------------|----------------------------------|------------------------------------|------------------|
| Range | Accuracy / Display update : SLOW | Accuracy / Display update : NORMAL | Shunt Resistance |
| 600.00 μA | ±0.05 %rdg. ±5 dgt. | ±0.05 %rdg. ±25 dgt. | 101 Ω |
| 6000.0 μA | | ±0.05 %rdg. ±5 dgt. | |
| 60.000 mA | ±0.15 %rdg. ±5 dgt. | ±0.05 %rdg. ±25 dgt. | 1 Ω |
| 600.00 mA | | ±0.15 %rdg. ±5 dgt. | |
| 6.0000 A ¹ | ±0.2 %rdg. ±5 dgt. | ±0.2 %rdg. ±25 dgt. | 10m Ω |
| 10.000 A ¹ | | ±0.2 %rdg. ±5 dgt. | |

| ACA Measurement | | | | | |
|-----------------------|-------------|-------------|-------------|---------------|----------------|
| Range | Accuracy | | | | |
| | 20 to 45 Hz | 45 to 65 Hz | 65 to 1 kHz | 1 k to 10 kHz | 10 k to 20 kHz |
| 600.00 μA | ±1.0 %rdg. | ±0.6 %rdg. | ±0.6 %rdg. | ±2 %rdg. | ±4 %rdg. |
| | ±20 dgt. | ±20 dgt. | ±20 dgt. | ±20 dgt. | ±20 dgt. |
| 6000.0 μA | ±1.0 %rdg. | ±0.6 %rdg. | ±0.6 %rdg. | ±2 %rdg. | ±4 %rdg. |
| | ±5 dgt. | ±5 dgt. | ±5 dgt. | ±5 dgt. | ±5 dgt. |
| 60.000 mA | ±1.0 %rdg. | ±0.6 %rdg. | ±0.6 %rdg. | ±1 %rdg. | ±2 %rdg. |
| | ±20 dgt. | ±20 dgt. | ±20 dgt. | ±20 dgt. | ±20 dgt. |
| 600.00 mA | ±1.0 %rdg. | ±0.6 %rdg. | ±0.6 %rdg. | ±1.5 %rdg. | Undefined |
| | ±5 dgt. | ±5 dgt. | ±5 dgt. | ±10 dgt. | |
| 6.0000 A ¹ | Undefined | ±0.8 %rdg. | ±0.8 %rdg. | Undefined | Undefined |
| | | ±20 dgt. | ±20 dgt. | | |
| 10.000 A ¹ | Undefined | ±0.8 %rdg. | ±0.8 %rdg. | Undefined | Undefined |
| | | ±5 dgt. | ±5 dgt. | | |

| | |
|------------------------------|--|
| Shunt resistance | μA Range 101Ω/ mA Range 1Ω/ A Range 10mΩ |
| Crest factor | 3 or less (Note that it applies to 1/2 of the range.) |
| Accuracy specification range | Accuracy is not defined for measurements below 5% of range |

| Continuity Check | | | |
|----------------------|--------------------------------|---------------------|-----------------------|
| Range | Accuracy | Measurement Current | Open-terminal Voltage |
| 600.0 Ω | ±0.5 %rdg. ±5 dgt. | 640 μA ±10% | DC2.5 V or less |
| Continuity threshold | 20Ω (default) /50Ω/ 100Ω/ 500Ω | | |

| Diode Check | | | |
|-------------------|---|---------------------|-----------------------|
| Range | Accuracy | Measurement Current | Open-terminal Voltage |
| 3.600 V | ±0.1 %rdg. ±5 dgt. | 1.2 mA or less | DC4.5 V or less |
| Forward threshold | 0.15V/ 0.5V (default)/1V/ 1.5V/ 2V/ 2.5V/ 3V If the reading is lower than the threshold during the forward connection, a buzzer sounds and the red backlight turns on. | | |

| AC Clamp (AC Current) | | |
|-----------------------|---------------------|---------------------|
| Range | Accuracy | |
| | 40 to 65 Hz | 65 to 1 kHz |
| 10.00 A | ±0.6 %rdg. ±2 dgt. | ±0.9 %rdg. ±2 dgt. |
| 20.00 A | ±0.6 %rdg. ±4 dgt. | ±0.9 %rdg. ±4 dgt. |
| 50.00 A | ±0.6 %rdg. ±10 dgt. | ±0.9 %rdg. ±10 dgt. |
| 100.0 A | ±0.6 %rdg. ±2 dgt. | ±0.9 %rdg. ±2 dgt. |
| 200.0 A | ±0.6 %rdg. ±4 dgt. | ±0.9 %rdg. ±4 dgt. |
| 500.0 A | ±0.6 %rdg. ±10 dgt. | ±0.9 %rdg. ±10 dgt. |
| 1000 A | ±0.6 %rdg. ±2 dgt. | ±0.9 %rdg. ±2 dgt. |

The optional 9010-50, 9018-50, or 9132-50 CLAMP ON PROBE is used. Accuracy does not include the error of the clamp-on probe.
Crest factor 3 or less
Accuracy is not defined for measurements below 15% of range

| Resistance Measurement | | | |
|------------------------|----------------------|---------------------|-----------------------|
| Range | Accuracy | Measurement Current | Open-terminal Voltage |
| 60.000 Ω | ±0.3 %rdg. ±20 dgt. | 640 μA ±10% | DC2.5 V or less |
| 600.00 Ω | ±0.03 %rdg. ±10 dgt. | | |
| 6.0000 kΩ | ±0.03 %rdg. ±2 dgt. | 96 μA ±10% | |
| 60.000 kΩ | | 9.3 μA ±10% | |
| 600.00 kΩ | | 0.96 μA ±10% | |
| 6.0000 MΩ | ±0.15 %rdg. ±4 dgt. | 96 nA ±10% | |
| 60.00 MΩ | ±1.5 %rdg. ±10 dgt. | | |
| 600.0 MΩ | ±3.0 %rdg. ±20 dgt. | | |
| | ±8.0 %rdg. ±20 dgt. | | |

| Conductance (nS) | | | |
|------------------|---------------------|---------------------|----------------------|
| Range | Accuracy | Measurement Current | Open-circuit Voltage |
| 600.00 nS | ±1.5 %rdg. ±10 dgt. | 96 nA ±10% | DC2.5 V or less |

Accuracy is defined for humidity 60% RH or less. Accuracy is defined for the range 20nS or more. In the case of 300 nS or more, ±20 dgt. is added

| Capacitance Measurement | | | |
|-------------------------|-------------------|---------------------|----------------------|
| Range | Accuracy | Measurement Current | Open-circuit Voltage |
| 1.000 nF | ±1 %rdg. ±20 dgt. | 32 μA ±10% | DC2.5 V or less |
| 10.00 nF | ±1 %rdg. ±5 dgt. | | |
| 100.0 nF | | | |
| 1.000 μF | ±2 %rdg. ±5 dgt. | 680 μA ±20% | DC3.1 V or less |
| 10.00 μF | | | |
| 100.0 μF | | | |
| 1.000 mF | | | |
| 10.00 mF | | | |
| 100.0 mF | ±2 %rdg. ±20 dgt. | | DC2.1 V or less |

| Temperature | | |
|-------------------|---------------------------------------|--------------------------|
| Thermocouple Type | Range | Accuracy |
| K | -40.0 to 800.0 °C (-40.0 to 1472.0°F) | ±0.5 %rdg. ±3 °C (5.4°F) |

The optional K Thermocouple DT4910 is used. Accuracy does not include the error of the K thermocouple

| Frequency (For AC V, DC+AC V, AC μA, AC mA, AC A) | |
|---|----------------------|
| Range | Accuracy |
| 99.999 Hz | ±0.005 %rdg. +3 dgt. |
| 999.99 Hz | |
| 9.9999 kHz | |
| 99.999 kHz | |
| 500.00 kHz | ±0.005 %rdg. +3 dgt. |

| | |
|---|---|
| Measurement range | 0.5Hz or more ([----] is displayed when frequency is less than 0.5Hz) |
| Pulse width | 1μs or more (DUTY ratio is 50%) |
| With the filter ON, accuracy is defined only for frequencies 100Hz or less. (For ACV, DC+ACV) | |

| Peak Measurement (For AC V, DC V, DC+AC V, Clamp, DC μA, DC mA, DC A, AC μA, AC mA, AC A) | | |
|---|--------------------------|----------------------|
| Main measurement | Signal width | Accuracy |
| DCV | 4ms or more (single) | ±2.0 %rdg. ±40 dgt. |
| | 1ms or more (repeated) | ±2.0 %rdg. ±100 dgt. |
| Other than DCV | 1ms or more (single) | ±2.0 %rdg. ±40 dgt. |
| | 250μs or more (repeated) | ±2.0 %rdg. ±100 dgt. |

| Decibel Conversion Measurement : Standard impedance (dBm) | |
|---|--|
| 4/8/16/32/50/75/93/110/125/135/150/200/250/300/500/600/800/900/1000/1200 Ω (default : 600 Ω) | |

General Specifications

| Durability | |
|--------------------------------------|--|
| Drop proof | YES |
| Operating temperature and humidity*1 | -15°C to 55°C |
| Storage temperature and humidity*2 | -30°C to 60°C |
| Dielectric strength | AC8.54kV (Between all input terminals and case) |
| Applicable standards | Safety : EN61010, EMC: EN61326, Waterproof and dustproof: IP40 |

*1 : -15°C to 55°C (5°F to 131°F), Up to 40°C (104°F): at 80%RH or less (non-condensating),
 40°C to 45°C (104°F to 113°F): at 60%RH or less (non-condensating),
 45°C to 55°C (113°F to 131°F): at 50%RH or less (non-condensating)
 *2 : 80%RH or less (non-condensating)

| Dimensions/Mass |
|---|
| 93mm(W)×197mm(H)×53mm(D)(3.66"W 7.76"H 2.09"D Inch) / 650g (including batteries) (23 oz.) |

| Safety | |
|--|---|
| Maximum rated voltage between input terminals and ground | CATIII1000 V/ CATIV600 V |
| Maximum rated voltage between terminals | Between the V and COM terminals : 1000 V DC/AC |
| Maximum rated current between terminals | Between the mA and COM terminals : 600mA DC/600mA AC Between the A and COM terminals : 10A DC/10A AC |

Accessories

TEST LEAD L9207-10 , Instruction Manual, LR6 alkaline battery×4

Standard DT4252/DT4253/DT4254/DT4255/DT4256 (Accuracy guaranteed for 1 year, Post-adjustment accuracy guaranteed for 1 year)

| DC Voltage | | *1 : DT4252 only | *2 : DT4254 only |
|---|--------------------|------------------|------------------|
| Range | Accuracy | Input Impedance | |
| High precision 600mV range ¹ | ±0.2 %rdg. ±5 dgt. | 10.2 MΩ ± 1.5 % | |
| 600.0 mV | ±0.5 %rdg. ±5 dgt. | 11.2 MΩ ± 2.0 % | |
| 6.000 V | ±0.3 %rdg. ±3 dgt. | 10.3 MΩ ± 2.0 % | |
| 60.00 V | | 10.2 MΩ ± 1.5 % | |
| 600.0 V | | 10.2 MΩ ± 1.5 % | |
| 1000 V | ±0.3 %rdg. ±3 dgt. | 10.2 MΩ ± 1.5 % | |
| 1500 V ² | ±0.3 %rdg. ±3 dgt. | 10.2 MΩ ± 1.5 % | |

| AC Voltage | | | |
|------------|--------------------|---------------------|-------------------------------|
| Range | Accuracy | | Input Impedance |
| | 40 to 500 Hz | 500 or more to 1kHz | |
| 6.000V | ±0.9 %rdg. ±3 dgt. | ±1.8 %rdg. ±3 dgt. | 11.2 MΩ ± 2.0%/100 pF or less |
| 60.00V | | | 10.3 MΩ ± 2.0%/100 or less |
| 600.0V | | | 10.2 MΩ ± 1.5%/100 or less |
| 1000V | | | 10.2 MΩ ± 1.5%/100 or less |

| AUTO V (Identification) DT4253/54/55/56 only | | | |
|--|--|---------------------|--|
| Range | Accuracy | | Input Impedance |
| | DC, 40 to 500 Hz | 500 or more to 1kHz | |
| 600.0 V | ±2.0 %rdg. ±3 dgt. | ±4.0 %rdg. ±3 dgt. | 900 kΩ ± 20% 1800 kΩ ± 20% ¹ |
| Crest factor | 3 up to 4000 counts and reduces linearly to 2 at 6000 counts. | | |
| Accuracy specification range | For ACV, minimum 1% of range; add ±5 dgt. when measuring at or below 5% of range With the filter ON, the accuracy is not specified at 100Hz/500Hz or more | | |

*1 : DT4254

| DCA Measurement DT4252/53/56 only | | |
|-----------------------------------|---------------------------------|------------------------|
| Range | Accuracy | Input Impedance |
| ● 60.00 μA | ±0.8 %rdg. ±5 dgt. | 1 kΩ±5 % |
| ● 600.0 μA | ±0.8 %rdg. ±5 dgt. | 1 kΩ±5 % |
| ● 6.000 mA | ±0.8 %rdg. ±5 dgt. | 15 Ω±40 % |
| ● 60.00 mA | ±0.8 %rdg. ±5 dgt. ¹ | 15 Ω±40 % ¹ |
| ● 600.0 mA | ±0.9 %rdg. ±5 dgt. | 35 mΩ±30 % |
| ● 6.000 A | ±0.9 %rdg. ±3 dgt. ² | 35 mΩ±30 % |
| ● 10.00 A | ±0.9 %rdg. ±3 dgt. ² | 35 mΩ±30 % |

● : DT4252 ● : DT4253 ● : DT4256

*1 : DT4256 : ±1.8 %rdg. ±15 dgt. Input Impedance : 35 mΩ±30 %

*2 : DT4252 : ±0.9 %rdg. ±5 dgt.

| ACA Measurement DT4252/56 only | | | |
|--------------------------------|--------------------|---------------------|-----------------|
| Range | Accuracy | | Input Impedance |
| | 40 to 500 Hz | 500 or more to 1kHz | |
| 600.0 mA ¹ | ±1.4 %rdg. ±5 dgt. | ±1.8 %rdg. ±5 dgt. | 35 mΩ±30 % |
| 6.000 A | ±1.4 %rdg. ±3 dgt. | ±1.8 %rdg. ±3 dgt. | 35 mΩ±30 % |
| 10.00 A | ±1.4 %rdg. ±3 dgt. | ±1.8 %rdg. ±3 dgt. | 35 mΩ±30 % |

Crest factor 3 up to 4000 counts and reduces linearly to 2 at 6000 counts.

Accuracy specification range Minimum 1% of range; add ±5 dgt. when measuring 300 counts or less

*1 : DT4256 only

| Electric Charge DT4254/55/56 only | | |
|-----------------------------------|-------------------------|----------------------------|
| Range | Detection voltage range | Detection Target Frequency |
| Hi | AC40 V to AC600 V | 50 Hz / 60 Hz |
| Lo | AC80 V to AC600 V | |

During voltage detection, a continuous buzzer sounds and the red LED lights up.

| Continuity Check DT4252/53/55/56 only | | | |
|---------------------------------------|---|---------------------|-----------------------|
| Range | Accuracy | Measurement Current | Open-terminal Voltage |
| 600.0 Ω | ±0.7 %rdg. ±5 dgt. | Approx. 200 μA | DC1.8 V or less |
| Continuity ON threshold | Approx. 25Ω or less (continuous buzzer sound, red LED lights) | | |
| Continuity OFF threshold | Approx. 245Ω or more | | |

| Diode Check DT4252/53/55/56 only | | | |
|----------------------------------|--|---------------------|-----------------------|
| Range | Accuracy | Measurement Current | Open-terminal Voltage |
| 1.500 V | ±0.5 %rdg. ±5 dgt. ¹ | Approx. 0.5 mA | DC5.0 V or less |
| Forward threshold | Buzzer sounds intermittently at 0.15V to 1.5V, the red LED flashes | | |

*1 : DT4255 : ±0.5 %rdg. ±8 dgt.

| AC Clamp (AC Current) DT4253/55/56 only | |
|---|--------------------|
| Range | Accuracy |
| 10.00 A | ±0.9 %rdg. ±3 dgt. |
| 20.00 A | |
| 50.0 A | |
| 100.0 A | |
| 200.0 A | |
| 500 A | |
| 1000 A | |

The optional 9010-50, 9018-50, or 9132-50 CLAMP ON PROBE is used. Accuracy does not include the error of the clamp-on probe.

| | |
|------------------------------|---|
| Crest factor | 3 or less |
| Accuracy specification range | Minimum 1% of range; add ±5 dgt. when measuring at or below 5% of range |

| Resistance Measurement DT4252/53/55/56 only | | | |
|---|---------------------------------|---------------------|-----------------------|
| Range | Accuracy | Measurement Current | Open-terminal Voltage |
| 600.0 Ω | ±0.7 %rdg. ±5 dgt. | Approx. 200 μA | DC1.8 V or less |
| 6.000 kΩ | ±0.7 %rdg. ±3 dgt. ¹ | Approx. 100 μA | |
| 60.00 kΩ | | Approx. 10 μA | |
| 600.0 kΩ | | Approx. 1 μA | |
| 6.000 MΩ | ±0.9 %rdg. ±3 dgt. ¹ | Approx. 100 nA | |
| 60.00 MΩ | ±1.5 %rdg. ±3 dgt. ¹ | Approx. 10 nA | |

Accuracy guarantee condition After zero adjustment has been performed

*1 : DT4252/4253 : ±5dgt.

| Capacitance Measurement DT4252/53/55/56 only | | | |
|--|---------------------------|-------------------------|-----------------------|
| Range | Accuracy | Measurement Current | Open-terminal Voltage |
| 1.000 μF | ±1.9 %rdg. ±5 dgt. | Approx. 10 n/100 n/1 μA | DC1.8 V or less |
| 10.00 μF | | Approx. 100 n/1 μ/10 μA | |
| 100.0 μF | | Approx. 1 μ/10 μ/100 μA | |
| 1.000 mF | Approx. 10 μ/100 μ/200 μA | | |
| 10.00 mF | ±5.0 %rdg. ±20 dgt. | Approx. 100 μ/200 μA | |

| Temperature DT4253 only | | |
|-------------------------|-------------------|------------------|
| Thermocouple Type | Range | Accuracy |
| K | -40.0 to 400.0 °C | ±0.5 %rdg. ±2 °C |

The optional K Thermocouple DT4910 is used. Accuracy does not include the error of the K thermocouple

| Frequency | |
|-----------------------|--------------------|
| Range | Accuracy |
| 99.99 Hz | ±0.1 %rdg. +1 dgt. |
| 999.9 Hz | |
| 9.999 kHz | |
| 99.99 kHz (V AC Only) | |
| | |

General Specifications

| Durability | |
|--------------------------------------|--|
| Drop proof | YES |
| Operating temperature and humidity*1 | -25°C to 65°C(DT4254/4255/4256) -10°C to 50°C(DT4252/4253) |
| Storage temperature and humidity*2 | -30°C to 70°C(DT4254/4255/4256) -30°C to 60°C(DT4252/4253) |
| Dielectric strength | AC8.54 kV (Between all input terminals and case) |
| Applicable standards | Safety : EN61010, EMC: EN61326, Waterproof and dustproof: IP42 |

*1 : -10°C to 50°C(14°F to 122°F), Up to 40°C(104°F): at 80%RH or less(non-condensating),
40°C to 45°C (104°F to 113°F): at 60%RH or less(non-condensating),
45°C to 55°C (113°F to 131°F): at 50%RH or less (non-condensating)
*1 : Up to 40°C(104°F): at 80%RH or less(non-condensating),
40°C to 65°C (104°F to 149°F): reduces linearly 80%rh to 25%rh or less
*2 : 80%RH or less (non-condensating)

| Dimensions/Mass |
|---|
| 84mm(W)×174mm(H)×52mm(D)(3.31"W 6.85"H 2.05"D) 390g (including batteries and holster) (13.8 oz.) |

Pocket DT4221/DT4222

(Accuracy guaranteed for 1 year, Post-adjustment accuracy guaranteed for 1 year)

| DC Voltage | | |
|------------|--------------------|-----------------|
| Range | Accuracy | Input Impedance |
| 600.0 mV | ±0.5 %rdg. ±5 dgt. | 11.2 MΩ ± 2.0 % |
| 6.000 V | | |
| 60.00 V | | 10.3 MΩ ± 2.0 % |
| 600.0 V | | |

| AC Voltage | | | |
|------------|--------------------|---------------------|-------------------------------|
| Range | Accuracy | | Input Impedance |
| | 40 to 500Hz | 500 or more to 1kHz | |
| 6.000 V | ±1.0 %rdg. ±3 dgt. | ±2.5 %rdg. ±3 dgt. | 11.2 MΩ ± 2.0%/100 pF or less |
| 60.00 V | | ±2.0 %rdg. ±3 dgt. | 10.3 MΩ ± 2.0%/100 pF or less |
| 600.0 V | | | 10.2 MΩ ± 1.5%/100 pF or less |

Crest factor 3 up to 4000 counts and reduces linearly to 2 at 6000 counts.
Accuracy specification range For ACV, minimum 1% of range; add ±5 dgt. when measuring at or below 5% of range
With the filter ON, the accuracy is not specified in 100Hz/500Hz or more

| AUTO V (Identification) DT4221 only | | | |
|-------------------------------------|--------------------|---------------------|-----------------|
| Range | Accuracy | | Input Impedance |
| | DC, 40 to 500 Hz | 500 or more to 1kHz | |
| 600.0 V | ±2.0 %rdg. ±3 dgt. | ±4.0 %rdg. ±3 dgt. | 900 kΩ ± 20 % |

Crest factor 3 up to 4000 counts and reduces linearly to 2 at 6000 counts.
Accuracy specification range For ACV, minimum 1% of range; add ±5 dgt. when measuring at or below 5% of range
With the filter ON, the accuracy is not specified in 100Hz/500Hz or more

| Electric Charge DT4221 only | |
|-----------------------------|----------------------------|
| Detection Voltage Range | Detection Target Frequency |
| AC80 V to AC600 V | 50 Hz / 60 Hz |

During voltage detection, a continuous buzzer sounds.

| Continuity Check | | | |
|--------------------------|---|---------------------|-----------------------|
| Range | Accuracy | Measurement Current | Open-terminal Voltage |
| 600.0 Ω | ±1.0 %rdg. ±5 dgt. | Approx. 200 μA | DC1.8 V or less |
| Continuity ON threshold | Approx. 25Ω or less (continuous buzzer sound) | | |
| Continuity OFF threshold | Approx.245Ω or more | | |

General Specifications

| Durability | |
|--------------------------------------|--|
| Drop proof | YES |
| Operating temperature and humidity*1 | -10°C to 50°C |
| Storage temperature and humidity*2 | -30°C to 60°C |
| Dielectric strength | AC7.06kV (Between all input terminals and case) |
| Applicable standards | Safety : EN61010, EMC: EN61326, Waterproof and dustproof: IP42 |

*1 : -10°C to 50°C(14°F to 122°F), Up to 40°C(104°F): at 80%RH or less(non-condensating),
40°C to 45°C (104°F to 113°F): at 60%RH or less(non-condensating),
45°C to 50°C (113°F to 122°F): at 50%RH or less (non-condensating)
*2 : 80%RH or less (non-condensating)

| Dimensions/Mass |
|---|
| 72mm(W)×149mm(H)×38mm(D) (2.83"W 5.87"H 1.50"D) 190g (including batteries and holster) (6.7 oz.) |

| Safety | |
|--|---|
| Maximum rated voltage between input terminals and ground | CATIII1000 V/ CATIV600 V |
| Maximum rated voltage between terminals | Between the V and COM terminals : DC1000 V/ AC1000 V*1 |
| Maximum rated current between terminals | Between the A and COM terminals : DC10 A/ AC10 A (DT4252/DT4256) Between the μA ,mAand COM terminals : DC60 mA (DT4253 only) |

*1 : DT4254 ---- DC1700 V/AC1000 V

Accessories

TEST LEAD L9207-10 / Instruction Manual / LR03 Alkaline battery×4
Holster (attached to the instrument, with a test lead holder)

| Diode Check DT4222 only | | | |
|-------------------------|--------------------|---------------------|-----------------------|
| Range | Accuracy | Measurement Current | Open-terminal Voltage |
| 1.500 V | ±0.9 %rdg. ±5 dgt. | Approx.0.5 mA | DC2.5 V or less |

| Resistance Measurement DT4222 only | | | |
|------------------------------------|--------------------|---------------------|-----------------------|
| Range | Accuracy | Measurement Current | Open-terminal Voltage |
| 600.0 Ω | ±0.9 %rdg. ±5 dgt. | Approx.200 μA | DC1.8 V or less |
| 6.000 kΩ | | Approx.100 μA | |
| 60.00 kΩ | | Approx.10 μA | |
| 600.0 kΩ | | Approx.1 μA | |
| 6.000 MΩ | | Approx.100 nA | |
| 60.00 MΩ | | Approx.10 nA | |

Accuracy guarantee condition After zero adjustment has been performed

| Capacitance Measurement DT4222 only | | | |
|-------------------------------------|--------------------|--------------------------|-----------------------|
| Range | Accuracy | Measurement Current | Open-terminal Voltage |
| 1.000 μF | ±1.9 %rdg. ±5 dgt. | Approx.10 n/100 n/1 μA | DC1.8 V or less |
| 10.00 μF | | Approx.100 n/1 μ/10 μA | |
| 100.0 μF | | Approx.1 μ/10 μ/100 μA | |
| 1.000 mF | | Approx.10 μ/100 μ/200 μA | |
| 10.00 mF | | Approx.100 μ/200 μA | |

| Frequency | |
|-----------|--------------------|
| Range | Accuracy |
| 99.99 Hz | ±0.1 %rdg. +2 dgt. |
| 999.9 Hz | |
| 9.999 kHz | |

| Safety | |
|--|---|
| Maximum rated voltage between input terminals and ground | CAT III 600V/ CAT IV300V |
| Maximum rated voltage between terminals | Between the V and COM terminals : 600 V DC/AC |

Accessories

TEST LEAD DT4911 / Instruction Manual / LR03 Alkaline battery×1
Holster (attached to the instrument, with a test lead holder.)

L9207-10 / DT4911 Options

DT4280/DT4250 Series (Bundled accessory)

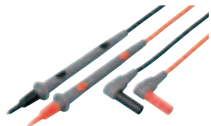

TEST LEAD L9207-10

Cable length 90 cm (2.9527 ft)
with one each red and black caps

with cap
CAT III 1000V/CAT IV 600V
without cap
CAT II 1000V

DT4220 Series (Bundled accessory)



TEST LEAD DT4911

Cable length 54cm (1.77 ft)
with one each red and black caps

with cap
CAT IV 300V/ CAT III 600V
without cap
CAT II 600V

L4933 and L4934 probe tips
(at right) can be used
on L9207-10/DT4911 test leads.

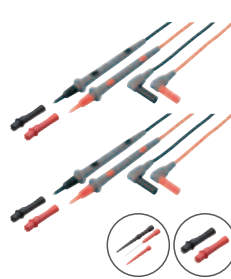

DC70V/AC33V
CONTACT PIN SET L4933



CAT II 600V
CAT III 300V
SMALL ALLIGATOR CLIP SET L4934

L4930 Options

Compatible DMMs: DT4250 Series / DT4280 Series



Length : 1.2m (3.937 ft)

CONNECTION CABLE L4930

Probe tips (at right) can be
used on L4930 connection
cables.

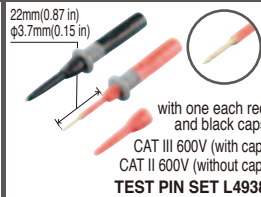

with one each red
and black caps
CAT III 600V (with cap)
CAT II 600V (without cap)
TEST PIN SET L4938



CAT III 1000V
CAT IV 600V
ALLIGATOR CLIP SET L4935

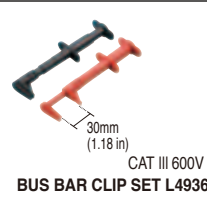

30mm
(1.18 in)
CAT III 600V
BUS BAR CLIP SET L4936

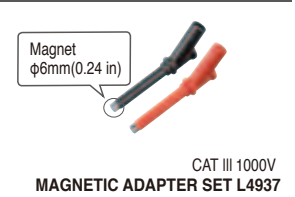

Magnet
φ6mm(0.24 in)
CAT III 1000V
MAGNETIC ADAPTER SET L4937

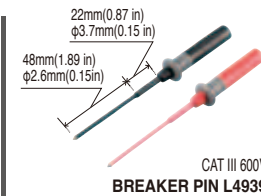

with one each red
and black caps
CAT III 600V
BREAKER PIN L4939



CAT III 1000V /CAT IV 600V
with one each red and black caps
TEST PIN SET L4932



CAT III 1000V
GRABBER CLIP 9243

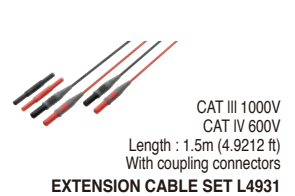

CAT III 1000V
CAT IV 600V
Length : 1.5m (4.9212 ft)
With coupling connectors
EXTENSION CABLE SET L4931

AC CLAMP ON PROBES for DT4281, DT4253, DT4255, DT4256 (Adapter 9704 required for connection)

| Product appearance | CAT III 600V | CAT III 600V | CAT III 600V |
|---------------------------------|--|--|----------------------------|
| Model number | 9010-50 | 9018-50 | 9132-50 |
| Rated current | AC 10/20/50/100/200/500 A | | AC 20/50/100/200/500/1000A |
| Amplitude accuracy (45 to 66Hz) | ±2% rdg. ±1% f.s. | ±1.5% rdg. ±0.1% f.s. | ±3% rdg. ±0.2% f.s. |
| Frequency characteristics | 40Hz to 1kHz:±6% rdg. | 40Hz to 3kHz:±1% rdg. | 40Hz to 1kHz:±1% rdg. |
| Output rate | AC 0.2 V f.s. (For each range) | | |
| Max. circuit voltage | AC600 V (50/60Hz) | | |
| Diameter | φ46mm (1.81 in) or less | φ55mm (2.17 in) or less, 80x20mm (3.15x0.79 in) | |
| Dimensions, mass | 78Wx188Hx35D mm (3.07W x 7.40H x 1.38D in) 420g (14.8oz.), cord length 3m (9.84 ft) | 100Wx224Hx35D mm(3.94W x8.82 H x 1.38D in) 600g(21.1oz.), cord length 3m(9.84 ft) | |

Adapter Model 9704 is required to connect
AC CLAMP ON PROBES 9010-50, 9018-
50 and 9132-50 to the DT4281, DT4253,
DT4255, DT4256.

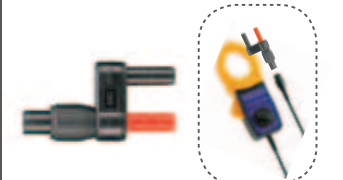

CONVERSION ADAPTER 9704

Other options



THERMOCOUPLES (K) DT4910

- Thermal junction form: exposed weld
- Sensor length: approx. 800 mm
- Measurement temperature range
-40 to 260°C
- Allowable tolerance:±2.5°C



COMMUNICATION PACKAGE (USB) DT4900-01

- Communication cable
- Communication adapter
- PC software
- Instruction manual
- OS: Windows 8.1/8/7, Vista
(SP1 or later)



MAGNETIC STRAP Z5004



CARRYING CASE C0200

DT4220 Series



CARRYING CASE C0202

DT4250/DT4280 Series



CARRYING CASE C0201

DT4250 Series



CARRYING CASE 3853

DT4250 Series

Note: Company names and Product names appearing in this catalog are trademarks or registered trademarks of various companies.

HIOKI

HIOKI E. E. CORPORATION

HEADQUARTERS

81 Koizumi, Ueda, Nagano, 386-1192, Japan
TEL +81-268-28-0562 FAX +81-268-28-0568
http://www.hioki.com / E-mail: os-com@hioki.co.jp

HIOKI USA CORPORATION

TEL +1-609-409-9109 FAX +1-609-409-9108
http://www.hioki.com / E-mail: hioki@hioki.com

HIOKI (Shanghai) SALES & TRADING CO., LTD.
TEL +86-21-63910090 FAX +86-21-63910360
http://www.hioki.cn / E-mail: info@hioki.com.cn

HIOKI INDIA PRIVATE LIMITED

TEL +91-124-6590210
E-mail: hioki@hioki.in

HIOKI SINGAPORE PTE. LTD.

TEL +65-6634-7677 FAX +65-6634-7477
E-mail: info-sg@hioki.com.sg

HIOKI KOREA CO., LTD.

TEL +82-2-2183-8847 FAX +82-2-2183-3360
E-mail: info-kr@hioki.co.jp

DISTRIBUTED BY