

## INTRODUCTION

Thank you for choosing an HK Instruments DPT-Ctrl-MOD series air handling controller with differential pressure or airflow transmitter. The DPT-Ctrl-MOD series PID controllers are engineered for building automation in the HVAC/R industry. With the built-in controller of the DPT-Ctrl-MOD it is possible to control the constant pressure or flow of fans, VAV systems or dampers. When controlling air flow, it is possible to select a fan manufacturer or a common measuring probe that has a K-value.

The DPT-Ctrl-MOD includes an Input terminal that enables the reading of multiple signals such as temperature or control relays over Modbus. The Input terminal has one input channel designed to accept 0–10 V, NTC10k, Pt1000, Ni1000/(-LG), and BIN IN (potential free contact) signals.

## APPLICATIONS

DPT-Ctrl-MOD series devices are commonly used in HVAC/R systems for:

- Controlling differential pressure or air flow in air handling systems
- VAV applications
- Controlling parking garage exhaust fans

## SPECIFICATIONS

### Performance

#### Accuracy (from applied pressure):

Model 2500:

Pressure < 125 Pa = 1 % + ±2 Pa

Pressure > 125 Pa = 1 % + ±1 Pa

Model 7000:

Pressure < 125 Pa = 1.5 % + ±2 Pa

Pressure > 125 Pa = 1.5 % + ±1 Pa

(Accuracy specifications include: general accuracy, linearity, hysteresis, long term stability, and repetition error)

#### Overpressure:

Proof pressure: 25 kPa

Burst pressure: 30 kPa

#### Zero point calibration:

Manual pushbutton or Modbus

#### Response time:

1.0–20 s, selectable via menu or Modbus

### Communication

Protocol: MODBUS over Serial Line

Transmission Mode: RTU

Interface: RS485

Byte format (11 bits) in RTU mode:

Coding system: 8-bit binary

Bits per byte:

1 start bit

8 data bits, least significant bit sent first

1 bit for parity

1 stop bit

Baud rate: selectable in configuration

Modbus address: 1–247 addresses selectable in configuration menu

### Technical Specifications

#### Media compatibility:

Dry air or non-aggressive gases

#### Controller parameter (selectable via menu and Modbus):

Setpoint 0...2500 (model 2500)

0...7000 (model 7000)

P-band 0...10 000

I-gain 0...1000

D-factor 0...1000

#### Pressure units (selectable via menu):

Pa, kPa, mbar, inWC, mmWC, psi

#### Flow units (selectable via menu):

Volume: m<sup>3</sup>/s, m<sup>3</sup>/hr, cfm, l/s

Velocity: m/s, ft/min

#### Measuring element:

MEMS, no flow-through

#### Environment:

Operating temperature: -20...50 °C

Temperature compensated range 0...50 °C

Storage temperature: -40...70 °C

Humidity: 0 to 95 % rH, non condensing

### Physical

#### Dimensions:

Case: 102.0 x 71.5 x 36.0 mm

#### Weight:

150 g

#### Mounting:

2 each 4.3 mm screw holes, one slotted

#### Materials:

Case: ABS

Lid: PC

Pressure inlets: Brass

#### Protection standard:

IP54

## WARNING

- READ THESE INSTRUCTIONS CAREFULLY BEFORE ATTEMPTING TO INSTALL, OPERATE OR SERVICE THIS DEVICE.
- Failure to observe safety information and comply with instructions can result in PERSONAL INJURY, DEATH AND/OR PROPERTY DAMAGE.
- To avoid electrical shock or damage to equipment, disconnect power before installing or servicing and use only wiring with insulation rated for full device operating voltage.
- To avoid potential fire and/or explosion do not use in potentially flammable or explosive atmospheres.
- Retain these instructions for future reference.
- This product, when installed, will be part of an engineered system whose specifications and performance characteristics are not designed or controlled by HK Instruments. Review applications and national and local codes to assure that the installation will be functional and safe. Use only experienced and knowledgeable technicians to install this device.

### Display

2-line display (12 characters/line)

Line 1: Direction of control output

Line 2: Pressure or air flow measurement, selectable via menu

If input is selected, line 2 shows also input information (for example temperature)

Size: 46.0 x 14.5 mm

#### Electrical connections:

4+4 position spring-loaded terminals

Wire: 0.2–1.5 mm<sup>2</sup> (16–24 AWG)

#### Cable entry:

Strain relief: M16

Knockout: 16 mm

#### Pressure fittings

5.2 mm barbed brass

+ High pressure

– Low pressure

### Electrical

#### Supply voltage:

24 VAC or VDC, ±10 %

#### Power consumption:

< 1.0 W

#### Output signal:

via Modbus

#### Control output:

0–10 V

#### Input signal:

0–10 V, NTC10k, Pt1000, Ni1000/(-LG) or BIN IN

### Conformance

Meets the requirements for:

	CE:	UKCA:
EMC:	2014/30/EU	S.I. 2016/1091
RoHS:	2011/65/EU	S.I. 2012/3032
WEEE:	2012/19/EU	S.I. 2013/3113

# SCHEMATICS

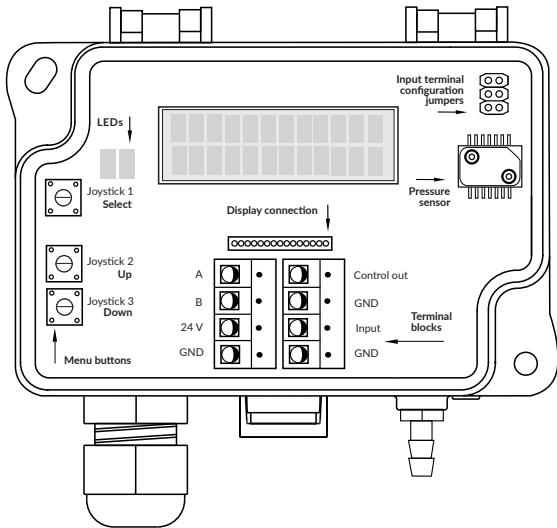

# INSTALLATION

- 1) Mount the device in the desired location (see step 1).
- 2) Open the lid and route the cable through the strain relief and connect the wires to the terminal block(s) (see step 2).
- 3) The device is now ready for configuration.

**WARNING!** Apply power only after the device is properly wired.

# STEP 1: MOUNTING THE DEVICE

- 1) Select the mounting location (duct, wall, panel).
- 2) Use the device as a template and mark the screw holes.
- 3) Mount with appropriate screws.

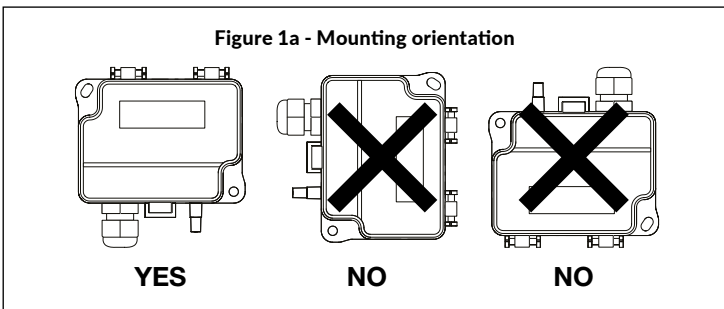

# STEP 2: WIRING DIAGRAMS

For CE compliance, a properly grounded shielding cable is required.

- 1) Unscrew the strain relief and route the cable(s).
- 2) Connect the wires as shown in figure 2a and 2b.
- 3) Tighten the strain relief.

It is recommended to use shielded twisted pair cable for Modbus cabling. The cable shield must be earthed only in one point, normally, at the end of the main cable.

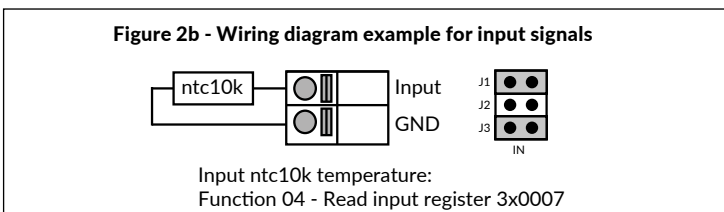
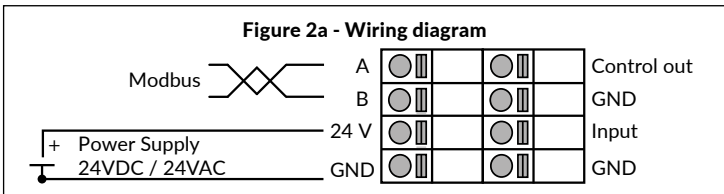

# STEP 3: CONFIGURATION

- 1) Press the select button for two seconds to open the device menu.
- 2) Zero point adjustment. For more information, see Step 4.



- 3) Select the functioning mode of the controller: PRESSURE or FLOW.
  - Select PRESSURE when controlling differential pressure. Go to point 3.1.
  - Select FLOW when controlling air flow. Go to point 3.2.0.

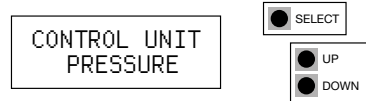

**When control unit PRESSURE is selected.**

- 3.1) Select pressure unit for display and output: Pa, kPa, mbar, inWC or mmWC. Then go to point 4.



**When control unit FLOW is selected.**

- 3.2.0) Select the functioning mode of the controller
  - Select *Manufacturer* when connecting DPT-Ctrl-MOD to a fan with pressure measurement taps.
  - Select *Common probe* when using DPT-Ctrl-MOD with a common measurement probe that follows the formula:  
 $q = k \cdot \sqrt{\Delta P}$  (i.e. FloXact)

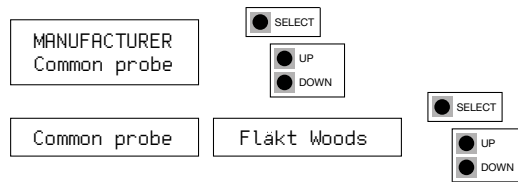

- 3.2.1) If *Common probe* selected: select measurement units used in the formula (aka Formula unit) (i.e. l/s)

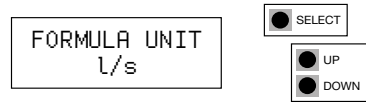

- 3.2.2) Select K-value

- a. If manufacturer selected in step 3.2.0: Each fan has a specific K-value. Select the K-value from fan manufacturer's specifications.
- b. If *Common probe* selected in step 3.2.0: Each common probe has a specific K-value. Select the K-value from common probe manufacturer's specifications. Available K-value range: 0.001...9999.000

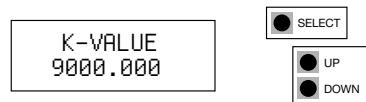

- 3.2.3) Select flow unit for display and output:

Flow volume: m³/s, m³/h, cfm, l/s  
Velocity: m/s, f/min



- 4) Select the address for Modbus: 1...247

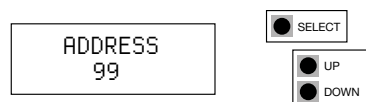

## CONFIGURATION CONTINUED

5) Select the baud rate: 9600/19200/38400.



6) Select the parity bit: None/Even/Odd

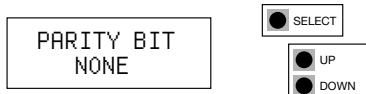

7) Select the response time: 1...20 s.

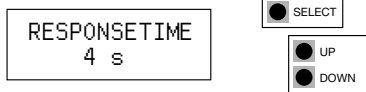

8) Select the Fixed Output (OFF / 0...100%), (see step 7 Fixed Output).

9) Select the input type.

Passive temperature sensors: PT1000 / Ni1000 / Ni1000LG / NTC10k

Voltage input: VINUT

Switch input: BIN IN

No input: NONE

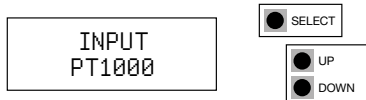

10) Select the setpoint of the controller (SP2 is only available with BIN IN switch information):

10.1) If the CONTROL UNIT is selected PRESSURE.

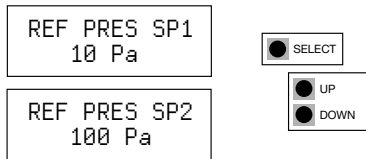

10.2) If the CONTROL UNIT is selected FLOW.

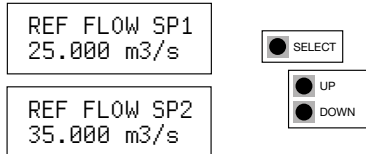

11) Select the TEMP COMP (OFF/ON), (see step 6, Temperature Compensation).

12) Select proportional band according to your application specifications.

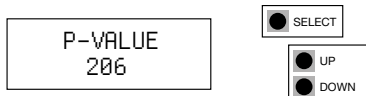

13) Select integral gain according to your application specifications.



14) Select derivation time according to your application specifications.



15) Push the select button to exit menu.

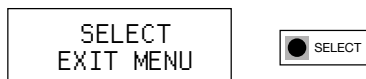

## STEP 4: ZERO POINT ADJUSTMENT

**NOTE! Always zero the device before use.**

Supply voltage must be connected one hour before the zero point adjustment is carried out. Access via Modbus or by push button.

- 1) Loose both tubes from the pressure inlets + and -.
- 2) Activate the device menu by pushing the the select button for 2 seconds.
- 3) Select Zero sensor by pressing the select button.
- 4) Wait until the LED turns off and then install tubes again for the pressure inlets.

## STEP 5: INPUT SIGNAL CONFIGURATION

Input signals can be read over Modbus via DPT-MOD RS485 interface.

Signals	Accuracy for measurement	Resolution
0...10 V	< 0,5 %	0,1 %
NTC10k	< 0,5 %	0,1 %
Pt1000	< 0,5 %	0,1 %
Ni1000(-LG)	< 0,5 %	0,1 %
BIN IN (potential free contact)		

The jumpers should be set according to the instructions below and the value should be read from the right register.

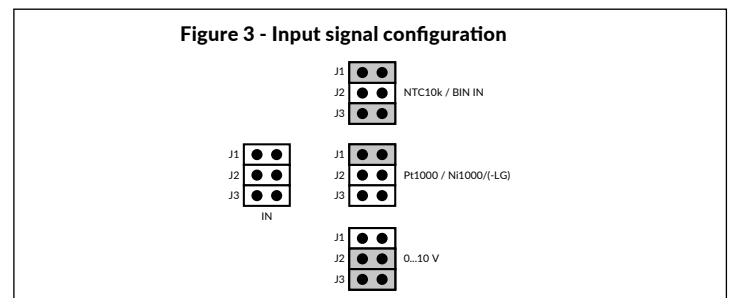

## STEP 6: TEMPERATURE COMPENSATION

The device includes an outdoor temperature compensation function that can be enabled from the menu. When activated and an outdoor temperature sensor is attached, the effective set point of the device will be modified to compensate for the cold outdoor air. This may result in energy savings.

If temperature compensation is enabled, the device will linearly decrease the user's setpoint (REF FLOW/REF PRESSURE) by 0 % to TC DROP % from TC START TE to TC STOP TE.

The device enforces a +5 °C difference between the start and stop temperatures. The start temperature must be higher than the stop temperature.

- 1) Connect and configure an outdoor air temperature sensor. See step 5.
- 2) Enable temperature compensation.



3) Set the starting temperature for compensation.



4) Set the stopping temperature for compensation.

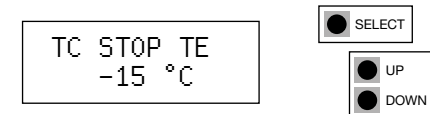

5) Set the maximum drop percentage for compensation.

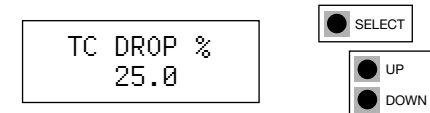

## STEP 7: FIXED OUTPUT

Fixed output settings can be enabled to set the control output to a preset value. Primary purpose of this functionality is to enable the adjustment of air valves and terminals without the DPT-Ctrl affecting the duct pressure or air flow. It can also aid in troubleshooting the installation.

1) To enable the fixed output, scroll to its position in the menu.



2) Press the select button and select the desired fixed output value. The output will now stay at this value indefinitely. In normal operation mode (shown below), the upper row of the display will show FIXED xx % to indicate the output is fixed.

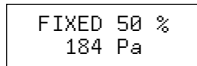

3) To enable the normal control output and disable the fixed output, scroll to its position, select it and set value to OFF.

Fixed output function is also available via Modbus. (4x0016: Overdrive active, 4x0015: Overdrive value)

## STEP 8: USING THE 2SP-FEATURE

2SP (setpoint) is a feature with a binary input to select between two user-adjustable setpoints. The desired setpoint can be selected, for example, with weekly clock, turn switch or key card switch.

1) Select INPUT => BIN IN.

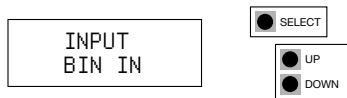

2) Set the jumpers as shown beside to determine the input signal.

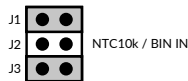

## STEP 9: MODBUS REGISTERS

Function code 03 - Read holding register, Function code 06 - Write single register, Function code 16 - Write multiple registers

Register	Parameter description	Data Type	Value	Range
4x0001	Manufacturer	16 bit	0...8	0 = FläktWoods 1 = Rosenberg, 2 = Nicotra-Gebhardt 3 = Comefri 4 = Ziehl-Abegg 5 = ebm-papst 6 = Gebhardt 7 = Nicotra 8 = Common probe
4x0002	Formula unit (if manufacturer selection = common probe)	16 bit	0...5	0=m3/s, 1=m3/h, 2=cfm, 3=l/s, 4=m/s, 5=f/min
4x0003	K-factor integral	16 bit	0...9999	0...9999
4x0004	K-factor decimal	16 bit	0...999	0...999
4x0005	Response time	16 bit	0...20	0...20 s
4x0006	PID control unit	16 bit	0...1	0=Pressure, 1=Flow
4x0007	PID pressure ref	16 bit	-250...2500 (model 2500) -700...7000 (model 7000)	-250...2500 (model 2500) -700...7000 (model 7000)
4x0008	PID flow ref integer	16 bit	0...30000	0...30000
4x0009	PID flow ref decimal	16 bit	0...999	0...999
4x0010	PID p value	16 bit	0...10000	0...10000
4x0011	PID i integer	16 bit	0...1000	0...1000
4x0012	PID i decimal	16 bit	0...99	0...99
4x0013	PID d integer	16 bit	0...1000	0...1000
4x0014	PID d decimal	16 bit	0...99	0...99
4x0015	Overdrive value	16 bit	0...100	0...100 %
4x0016	Overdrive active	16 bit	0...1	0=Off, 1=On
4x0017	Temperature compensation	16 bit	0...1	0=Off, 1=On
4x0018	Temp. comp. start TE	16 bit	-45...50	-45...50 °C
4x0019	Temp. comp. stop TE	16 bit	-50...45	-50...45 °C
4x0020	Temp. comp. drop integer part	16 bit	0...99	0...99 %
4x0021	Temp. comp. drop decimal part	16 bit	0...999	0.0...0.999 %
4x0022	PID Pressure Ref SP 1	16 bit	-250...2500 (model 2500) -700...7000 (model 7000)	-250...2500 (model 2500) -700...7000 (model 7000)
4x0023	PID Pressure Ref SP 2	16 bit	-250...2500 (model 2500) -700...7000 (model 7000)	-250...2500 (model 2500) -700...7000 (model 7000)
4x0024	PID Flow Ref SP 1 integer	16 bit	0...30000	0...30000
4x0025	PID Flow Ref SP 1 decimal	16 bit	0...999	0...999
4x0026	PID Flow Ref SP 2 integer	16 bit	0...30000	0...30000
4x0027	PID Flow Ref SP 2 decimal	16 bit	0...999	0...999
4x0028	Flow unit (display and PID SP)	16 bit	0...5	0=m3/s, 1=m3/h, 2=cfm, 3=l/s, 4=m/s, 5=f/min

## MODBUS REGISTERS CONTINUED

Function code 04 - Read input register

Register	Parameter description	Data Type	Value	Range
3x0001	Program version	16 bit	0...1000	100...9900
3x0002	Pressure reading A	16 bit	-250...2500 (model 2500) -700...7000 (model 7000)	-250...2500 (model 2500) -700...7000 (model 7000)
3x0003	Input 0...10 V	16 bit	0...100	0...100 %
3x0004	Input PT1000	16 bit	-500...500	-50...+50 °C
3x0005	Input Ni1000	16 bit	-500...500	-50...+50 °C
3x0006	Input Ni1000-LG	16 bit	-500...500	-50...+50 °C
3x0007	Input NTC10k	16 bit	-500...500	-50...+50 °C
3x0008	Flow m3/s	16 bit	0...10000	0...100 m3/s
3x0009	Flow m3/h	16 bit	0...30000	0...30000 m3/h
3x0010	Flow cfm	16 bit	0...30000	0...30000 cfm
3x0011	Flow l/s	16 bit	0...3000	0...3000 l/s
3x0012	Velocity m/s	16 bit	0...1000	0...100 m/s
3x0013	Velocity f/min	16 bit	0...5000	0...5000 f/min

Function code 02 - Read input status

Register	Parameter description	Data Type	Value	Range
1x0001	Input: BIN IN	Bit 0	0...1	0=Off, 1=On

Function code 05 - Write single coil

Register	Parameter description	Data Type	Value	Range
0x0001	Zeroing function	Bit 0	0...1	0=Off, 1=On

## RECYCLING/DISPOSAL

The parts left over from installation should be recycled according to your local instructions. Decommissioned devices should be taken to a recycling site that specializes in electronic waste.



## WARRANTY POLICY

The seller is obligated to provide a warranty of five years for the delivered goods regarding material and manufacturing. The warranty period is considered to start on the delivery date of the product. If a defect in raw materials or a production flaw is found, the seller is obligated, when the product is sent to the seller without delay or before expiration of the warranty, to amend the mistake at his/her discretion either by repairing the defective product or by delivering free of charge to the buyer a new flawless product and sending it to the buyer. Delivery costs for the repair under warranty will be paid by the buyer and the return costs by the seller. The warranty does not comprise damages caused by accident, lightning, flood or other natural phenomenon, normal wear and tear, improper or careless handling, abnormal use, overloading, improper storage, incorrect care or reconstruction, or changes and installation work not done by the seller. The selection of materials for devices prone to corrosion is the buyer's responsibility, unless otherwise is legally agreed upon. Should the manufacturer alter the structure of the device, the seller is not obligated to make comparable changes to devices already purchased. Appealing for warranty requires that the buyer has correctly fulfilled his/her duties arisen from the delivery and stated in the contract. The seller will give a new warranty for goods that have been replaced or repaired within the warranty, however only to the expiration of the original product's warranty time. The warranty includes the repair of a defective part or device, or if needed, a new part or device, but not installation or exchange costs. Under no circumstance is the seller liable for damages compensation for indirect damage.