



# PDA015A(/M) Si Amplified Detector

## User Guide





















## Table of Contents

|            |  |    |
|------------|--|----|
| Chapter 1  | Warning Symbol Definitions .....                             | 2  |
| Chapter 2  | Safety .....   | 3  |
| Chapter 3  | Description.....   | 5  |
|            | 3.1. <i>Introduction</i> .....                               | 5  |
|            | 3.2. <i>Maintenance and Care</i> .....                       | 5  |
| Chapter 4  | Setup Guide .....  | 6  |
| Chapter 5  | Operation.....   | 8  |
|            | 5.1. <i>Theory of Operation</i> .....                        | 8  |
|            | 5.2. <i>Responsivity and Dark Current</i> .....              | 8  |
|            | 5.3. <i>Transimpedance and Conversion Gain</i> .....         | 9  |
| Chapter 6  | Troubleshooting .....  | 10 |
| Chapter 7  | Specifications .....   | 11 |
|            | 7.1. <i>Responsivity</i> .....                               | 13 |
|            | 7.2. <i>Temporal Response</i> .....                          | 13 |
|            | 7.3. <i>Frequency Response</i> .....                         | 14 |
|            | 7.4. <i>Electrical Return Loss</i> .....                     | 15 |
|            | 7.5. <i>Noise Spectrum</i> .....                             | 15 |
|            | 7.6. <i>Noise Equivalent Power (NEP)</i> .....               | 16 |
|            | 7.7. <i>Mechanical Drawing</i> .....                         | 17 |
| Chapter 8  | Certificate of Compliance .....                              | 18 |
| Chapter 9  | Regulatory .....   | 19 |
|            | 9.1. <i>Waste Treatment is Your Own Responsibility</i> ..... | 19 |
|            | 9.2. <i>Ecological Background</i> .....                      | 19 |
| Chapter 10 | Thorlabs Worldwide Contacts.....                             | 20 |

# Chapter 1 Warning Symbol Definitions

Below is a list of warning symbols you may encounter in this manual or on your device.

| Symbol  | Description                              |
|---|--|
|    | Direct Current                           |
|    | Alternating Current                      |
|    | Both Direct and Alternating Current      |
|    | Earth Ground Terminal                    |
|    | Protective Conductor Terminal            |
|    | Frame or Chassis Terminal                |
|    | Equipotentiality                         |
|    | On (Supply)                              |
|    | Off (Supply)                             |
|    | In Position of a Bi-Stable Push Control  |
|   | Out Position of a Bi-Stable Push Control |
|  | Caution: Risk of Electric Shock          |
|  | Caution: Hot Surface                     |
|  | Caution: Risk of Danger                  |
|  | Warning: Laser Radiation                 |
|  | Caution: Spinning Blades May Cause Harm  |
|  | Caution: ESD Sensitive Components        |

## Chapter 2 Safety



### CAUTION



The following statement applies to the products covered in this manual, unless otherwise specified herein. The statement for other products will appear in the accompanying documentation. Inputs and outputs must only be connected with shielded connection cables.

Only with written consent from Thorlabs may changes to single components be carried out or components not supplied by Thorlabs be used.

This product has been tested and found to comply with the limits according to IEC 61326-1 for using connection cables shorter than 3 meters (9.8 feet).

This equipment has been tested and found to comply with the limits for a Class A digital device, pursuant to Part 15 of the FCC Rules, and meets all requirements of the Canadian Interference Causing Equipment Standard ICES-003 for digital apparatus. These limits are designed to provide reasonable protection against harmful interference in an industrial installation. This equipment generates, uses, and can radiate radio frequency energy and, if not installed and used in accordance with the instructions, may cause harmful interference to radio communications. However, there is no guarantee that interference will not occur in a particular installation.

Thorlabs is not responsible for any radio television interference caused by modifications of this equipment or the substitution or attachment of connecting cables and equipment other than those specified by Thorlabs. The correction of interference caused by such unauthorized modification, substitution or attachment will be the responsibility of the user. The use of shielded I/O cables is required when connecting this equipment to any and all optional peripheral or host devices. Failure to do so may violate FCC and ICES rules.

The safety of any system incorporating the equipment is the responsibility of the assembler of the system.

If equipment is used in a manner not specified by the manufacturer, the protection provided by the equipment may be impaired.

This instrument should be kept clear of environments where liquid spills or condensing moisture are likely. It is not water resistant. To avoid damage to the instrument, do not expose it to spray, liquids, or solvents.



**ESD CAUTION**



The components inside this instrument are ESD sensitive. Take all appropriate precautions to discharge personnel and equipment before making any electrical connections to the unit.



**LASER WARNING**



When working with radiation sources that may be hazardous, follow manufacturers' recommendation for eye or skin protection.

## Chapter 3 Description

### 3.1. Introduction

The PDA015A(M), shown in Figure 1, is a high-speed amplified silicon photodetector designed for detection of optical signals over the 400 to 1000 nm wavelength range. It has a frequency response from DC to 380 MHz, a 1 ns impulse response time, and a maximum transimpedance gain of 50 kV/A. A buffered output drives 50  $\Omega$  loads up to 5 V with an NEP of 36 pW/ $\sqrt{\text{Hz}}$ .

A  $\pm 12$  VDC power supply is included with each amplified photodetector, and a switch on the power supply can be toggled to select the appropriate input voltage (115 or 230 VAC). The PDA015A housing includes a removable threaded coupler (SM1T1) and retaining ring (SM1RR) that are compatible with any of Thorlabs' SM1-threaded (1.035"-40) accessories. The housing also accommodates Thorlabs' SM05-threaded (0.535"-40) series of adapters and accessories. This allows convenient mounting of external optics, light filters, and apertures, as well as providing an easy mounting mechanism using Thorlabs' cage assembly accessories. Versions with imperial or metric tapped mounting holes, the PDA015A and PDA015A/M respectively, are available.

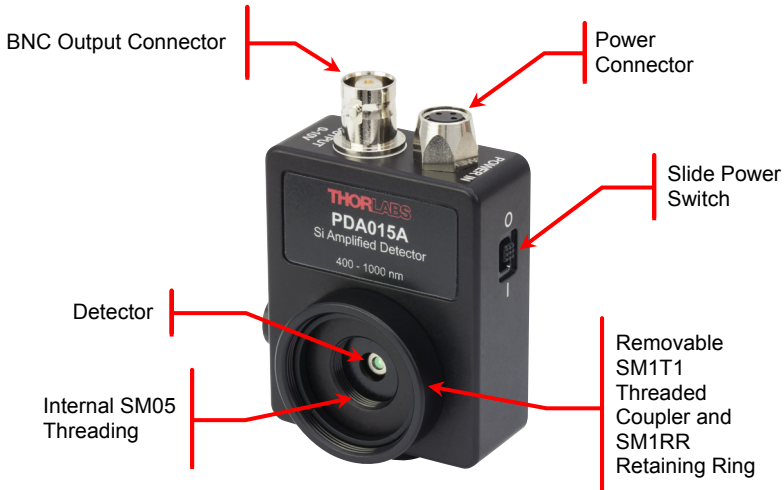

### 3.2. Maintenance and Care

**Figure 1. Features of the PDA015A Amplified Si Photodetector**

There are no serviceable parts in the PDA015A optical head or power supply. The housing may be cleaned by wiping with a soft damp cloth. The window of the detector should only be cleaned using optical grade wipes. If you suspect a problem with your PDA015A, please contact us at [techsupport@thorlabs.com](mailto:techsupport@thorlabs.com) and an engineer will be happy to assist you.

## Chapter 4 Setup Guide

The detector can be set up in many different ways using our extensive line of adapters. However, the detector should always be mounted and secured for best operation.

1. Unpack the optical head, install a Thorlabs TR-series ½" diameter post into one of the 8-32 (M4 on the PDA015A/M) tapped holes, located on the bottom and side of the head, and mount into a PH-series post holder.
2. Connect the power supply 3-pin plug into the power receptacle on the PDA015A.
3. Set the voltage selector switch on the power supply to the appropriate input voltage (115 or 230 VAC), then plug into a 50 - 60 Hz outlet.



### CAUTION



**If the voltage selector switch on the LDS1212 power supply is set to the wrong voltage, the power supply of the PDA015A may be damaged. Always ensure that the LDS1212 voltage selector switch is set correctly before plugging the power supply into mains power.**

4. Attach a 50  $\Omega$  BNC-type coaxial cable (i.e. RG-58U) to the output of the PDA. For best performance, we recommend terminating the cable with a 50  $\Omega$  load at the measurement instrument. If the instrument has a high impedance input, then adding an external 50  $\Omega$  load resistor may be an option. Do not add an external 50  $\Omega$  resistor if the instrument has an internal 50  $\Omega$  termination, as the resulting 25  $\Omega$  load could damage the output of the PDA015A.
5. Power the PDA015A on by moving the power switch located on the side of the unit to the "I" position. ("O" indicates the unit is off.) Note that Steps 4 and 5 can be reversed when using sensitive test equipment.



### CAUTION



**Immediately after the power is switched on, the output of the PDA015A will go to its maximum voltage (5 V for 50  $\Omega$  load or 10 V for Hi-Z) for approximately 200 ms. For sensitive equipment, turn on the PDA015A before connecting to its output.**

6. Install any desired filters, optics, adapters, or fiber adapters to the input aperture.
7. Apply the light source to the detector. Be sure not to overfill the detector area, as this can affect the frequency response.



8. The maximum output of the PDA015A is 10 V for high impedance loads and 5 V for 50  $\Omega$  loads. The output signal should be below the maximum output voltage to avoid saturation. If necessary, use external neutral density filters to reduce the input light level.



**CAUTION**



The PDA015A was designed to allow maximum accessibility to the photodetector by having the front surface of the PD TO-can nearly flush with the outside of the PDA housing. When using fiber adapters, make sure that the fiber ferrule does not crash into the TO-can window. Failure to do so may cause damage to the TO-can window and/or the fiber.

## Chapter 5 Operation

### 5.1. Theory of Operation

Thorlabs' PDA015A is ideal for measuring both modulated/pulsed and CW light sources. As is shown in Figure 2, the PDA015A includes a reverse-biased PIN photodiode (PD) mated to a fixed gain transimpedance amplifier (TIA) followed by a buffer amplifier, and packaged in a rugged housing. The photodiode generates a current in response to the optical input which is then converted to a voltage and amplified by the TIA. The Buffer Amplifier adds yet another level of gain. Note that the output is passed through a 50  $\Omega$  series resistor before reaching the output connector. The user can apply either a 50  $\Omega$  or high-impedance external load depending on the situation.

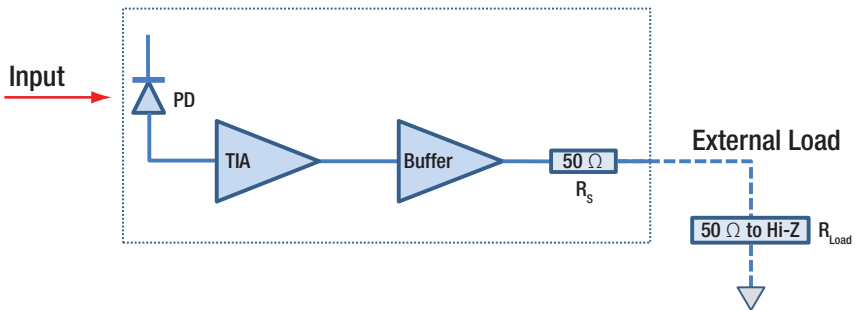

Figure 2. Block Diagram of the PDA015A Amplified Si Photodetector

### 5.2. Responsivity and Dark Current

The responsivity of a photodiode can be defined as a ratio of generated photocurrent ( $I_{PD}$ ) to the incident light power ( $P$ ) at a given wavelength (in units of A/W):

$$\mathfrak{R}(\lambda_p) = \frac{I_{PD}}{P}$$

The dark current is defined as the current from the photodiode when no light is applied. Depending on the photodiode size, material, and reverse-bias voltage, the dark current can range from less than a nA up to many  $\mu$ A. In the case of the PDA015A, in most cases the dark current is small enough to ignore ( $<3$  nA).

Note that the PDA015A also has a dark output voltage (see specifications in Chapter 7), which is dominated by the input offset voltage error of the TIA. This is significantly larger than any contribution due to the PD dark current.

### 5.3. Transimpedance and Conversion Gain

The Transimpedance Gain (TG) of the PDA015A is the total gain of both amplifier stages (in units of V/A).

The Conversion Gain (CG) (in units of V/W) is simply the product of the photodiode Responsivity ( $\mathfrak{R}(\lambda_p)$ ) and the Transimpedance Gain.

As a result, the output voltage for a given optical power and wavelength is given by the input optical power times the Conversion Gain.

However, the user should be aware that changing the final load resistance on the PDA015A changes the conversion gain of the system. This is due to the internal 50  $\Omega$  series resistor shown in the block diagram.

The final load resistance creates a voltage divider with the 50  $\Omega$  series resistor ( $R_s$ ). This changes the CG according to the following Scale Factor.

$$Factor = \frac{R_{Load}}{R_{Load} + R_s}$$

The actual CG is then given by the CG times the Scale Factor. Note that for a high impedance external load, the CG and actual CG are the same. For a 50  $\Omega$  external load, the actual CG is a factor of two smaller than the CG.

It is for this reason that the maximum output of the PDA015A is 10 volts for high impedance loads and 5 volts for 50  $\Omega$  loads. The user should also be aware that the linear, low distortion output range of the PDA015A is limited to about 6 volts (3 volts with a 50  $\Omega$  load) at maximum bandwidth to avoid saturation. This is limited by the maximum slew rate of the amplifier. Larger, linear swing can be achieved when not running at maximum bandwidth.

For best signal integrity, we recommend using a 50  $\Omega$  coaxial cable with a 50  $\Omega$  terminating resistor at the output end of the cable. This will minimize ringing by matching the cable with its characteristic impedance. If more output voltage is required, the load resistance can be increased. However, when the load resistance does not match the cable impedance, the length of the coaxial cable can have a negative impact on the signal integrity, unless the cable is kept very short.

The PDA015A is DC coupled, which means there is no low frequency cutoff and the output voltage will have a DC component that is proportional to the average optical power. Some instruments such as spectrum analyzers may require a DC block to prevent damage to the instrument. If a DC block is used, ensure that it has a flat frequency response up to 1 GHz to avoid adding distortion.

Some instruments may not support the high output voltage capability of the PDA015A. In these cases an RF attenuator can be added between the PDA015A and the instrument to prevent damage to the instrument. If an attenuator is added ensure that it supports at least 1 GHz bandwidth to avoid adding distortion. Also, note that RF attenuators are typically only meant to be used in 50  $\Omega$  systems and the attenuator will not perform correctly with an instrument with high impedance inputs.

## Chapter 6 Troubleshooting

| Problem  | Suggested Solutions   |
|--|---|
| <b>There is no signal response.</b>  | Verify that the power is switched on and all connections are secure.  |
|  | Verify that the power indicator LED on the power supply and the LED on the PDA are both on.   |
|  | Verify that the optical signal wavelength is within the specified wavelength range.   |
|  | Verify that the optical signal is illuminating the detector active area.  |
| <b>Output Voltage will not increase.</b><br><b>Detector Output is distorted.</b> | Check to make sure the detector is not saturated. Refer to the Output Voltage spec. in the Specifications table.<br>Be sure that no stray or unwanted light is entering the detector.<br>Install a 1" Lens Tube (SM1L10) to the thread coupler (SM1T1) to baffle any external light sources to see if this improves the response. |

# Chapter 7 Specifications

| Electrical Specifications <sup>a</sup> |                          |                                     |
|--|--------------------------|-------------------------------------|
| Detector                               |                          | Si PIN Photodiode                   |
| Active Area                            |                          | Ø150 µm (0.018 mm <sup>2</sup> )    |
| Wavelength Range                       | $\lambda$                | 400 to 1000 nm                      |
| Peak Wavelength                        | $\lambda_p$              | 740 nm                              |
| Optical Input Power, Max <sup>b</sup>  |                          | 350 µW                              |
| Peak Responsivity                      | $\mathcal{R}(\lambda_p)$ | 0.47 A/W                            |
| Small Signal Bandwidth                 |                          | 380 MHz                             |
| Impulse Response                       |                          | 1 ns (FWHM)                         |
| NEP ( $\lambda_p$ ) <sup>c</sup>       |                          | 36 pW/√Hz (DC - 380MHz)             |
| Output Noise (RMS) <sup>c</sup>        |                          | 8 mV <sub>RMS</sub> (DC - 380MHz)   |
| Output Current, Max                    | $I_{OUT}$                | 100 mA                              |
| Output Dark Offset                     |                          | 20 mV                               |
| Load Impedance                         |                          | 50 Ω to Hi-Z                        |
| Transimpedance Gain                    |                          |                                     |
| Hi-Z Load                              |                          | 5x10 <sup>4</sup> V/A               |
| 50 Ω Load                              |                          | 2.5x10 <sup>4</sup> V/A             |
| Output Voltage                         | $V_{OUT}$                | 0 to 5 V (50 Ω)<br>0 to 10 V (Hi-Z) |
| Linear Output <sup>d</sup> , Max       |                          | 3 V (50 Ω)<br>6 V (Hi-Z)            |
| Output Slew Rate, Max                  |                          | 2.5 V/ns (50 Ω)<br>5 V/ns (Hi-Z)    |

<sup>a</sup>All performance specifications are typical and assume a 50 Ω load unless stated otherwise.

<sup>b</sup>For Linear Operation

<sup>c</sup>Measured with a 50 Ω Load

<sup>d</sup>Linear operating range is restricted due to slew rate limitations at maximum bandwidth.

| General Specifications                        |  |
|---|--|
| <b>On/Off Switch</b>                          | Slide  |
| <b>Output</b>                                 | BNC (DC Coupled)<br>50 $\Omega$ Impedance              |
| <b>Package Dimensions<br/>(without SM1T1)</b> | 1.89" x 2.76" x 0.83"<br>(48.0 mm x 70.2 mm x 21.1 mm) |
| <b>Package Dimensions<br/>(with SM1T1)</b>    | 1.89" x 2.76" x 1.04"<br>(48.0 mm x 70.2 mm x 26.4 mm) |
| <b>PD Surface Depth<sup>a</sup></b>           | 0.17" (4.4 mm)   |
| <b>Weight, Detector Only</b>                  | 0.15 lbs   |
| <b>Accessories</b>                            | SM1T1 Coupler<br>SM1RR Retainer Ring                   |
| <b>Operating Temp</b>                         | 10 to 40 °C  |
| <b>Storage Temp</b>                           | -25 to 70 °C   |
| AC/DC Power Supply (LDS1212)                  |  |
| <b>DC Output</b>                              | +12.0 V @ 0.25 A, -12.0 V @ 0.25 A                     |
| <b>Input Voltage</b>                          | 115 / 230 VAC (Switch Selectable)                      |
| <b>Output Regulation</b>                      | $\pm 5\%$ Measured at Output Connector                 |
| <b>Output Power (Rated)</b>                   | 6 W (Max)  |
| <b>Input Current</b>                          | 0.95 A @ 115 VAC / 1.05 A @ 230 VAC                    |
| <b>Input Frequency</b>                        | 60 / 50 Hz   |

<sup>a</sup>The Distance from the Front Edge of the External SM1 Threading to the Active Surface of the Photodiode

### 7.1. Responsivity

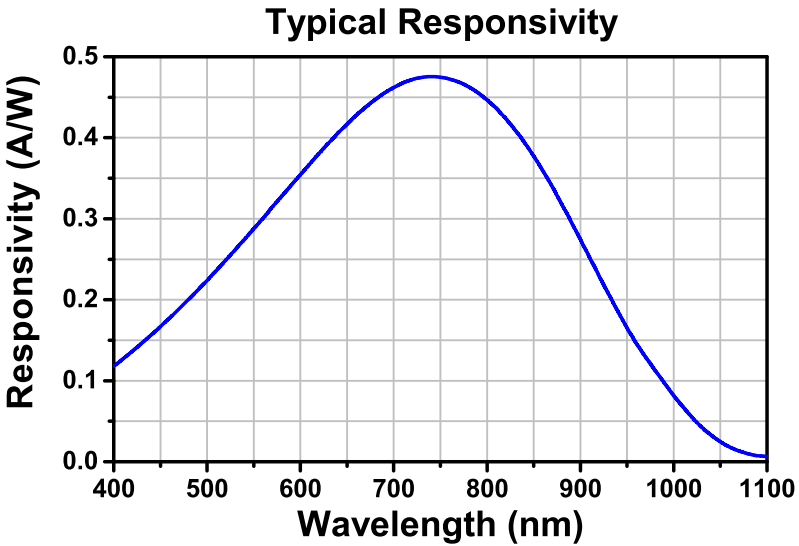

Figure 3. Typical Responsivity of the PDA015A

### 7.2. Temporal Response

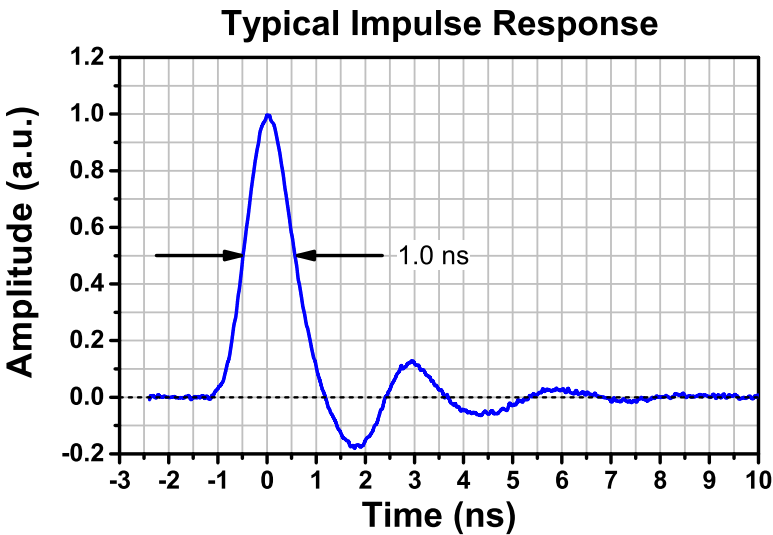

Figure 4. Typical Impulse Response of the PDA015A

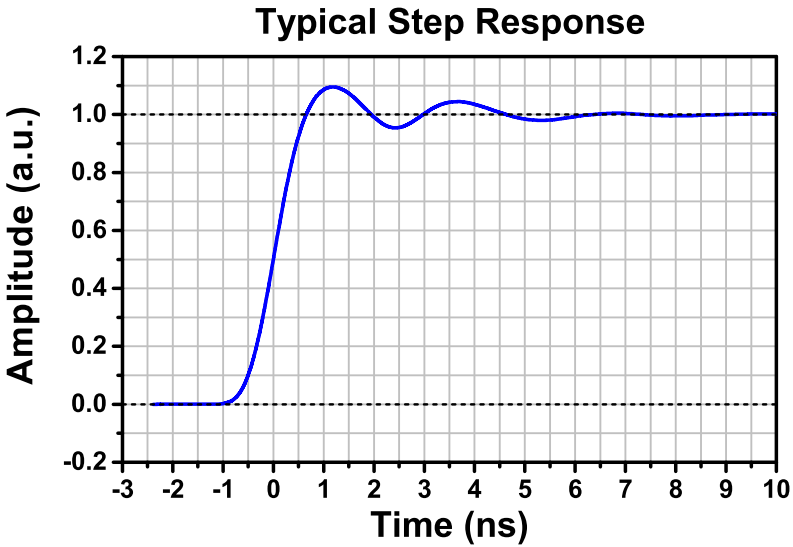

Figure 5. Typical Step response of the PDA015A

### 7.3. Frequency Response

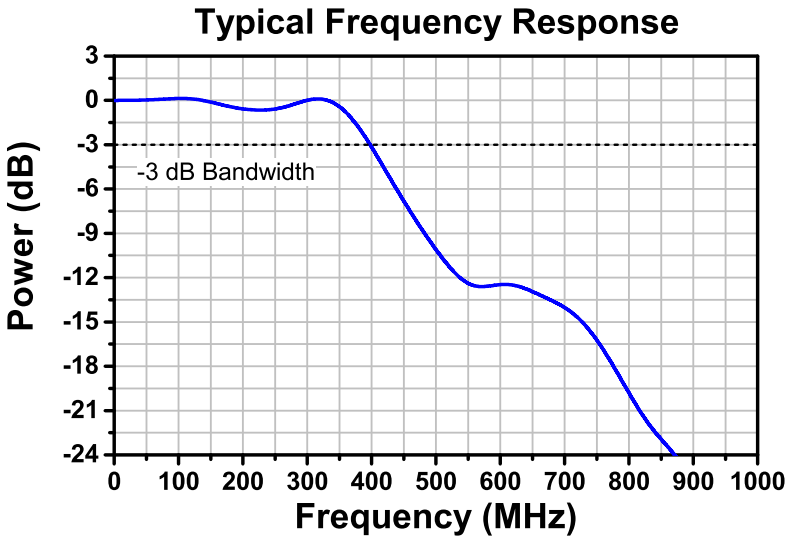

Figure 6. Typical Frequency Response of the PDA015A



### 7.4. Electrical Return Loss

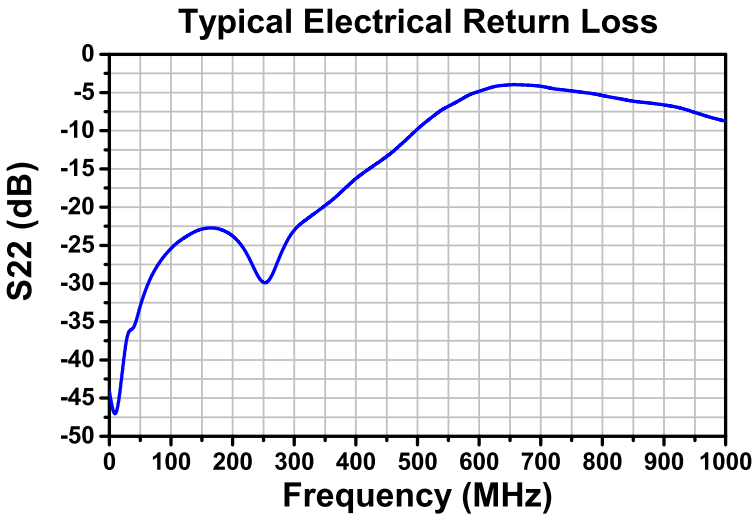

Figure 7. Typical Electrical Return Loss of the PDA015A

### 7.5. Noise Spectrum

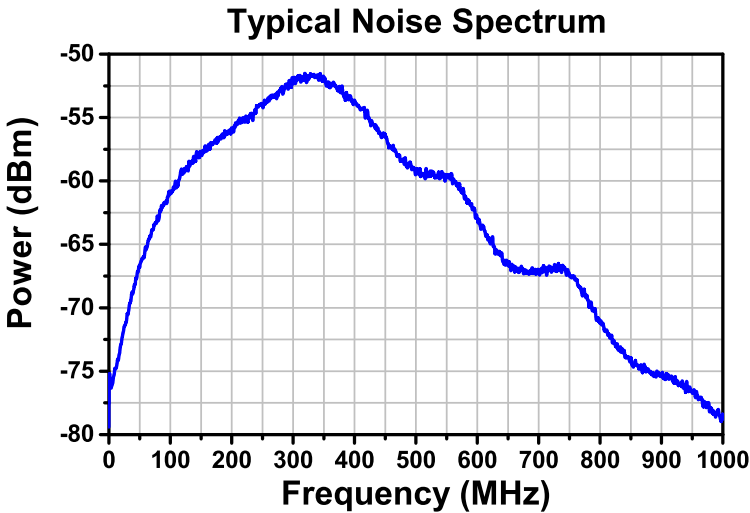
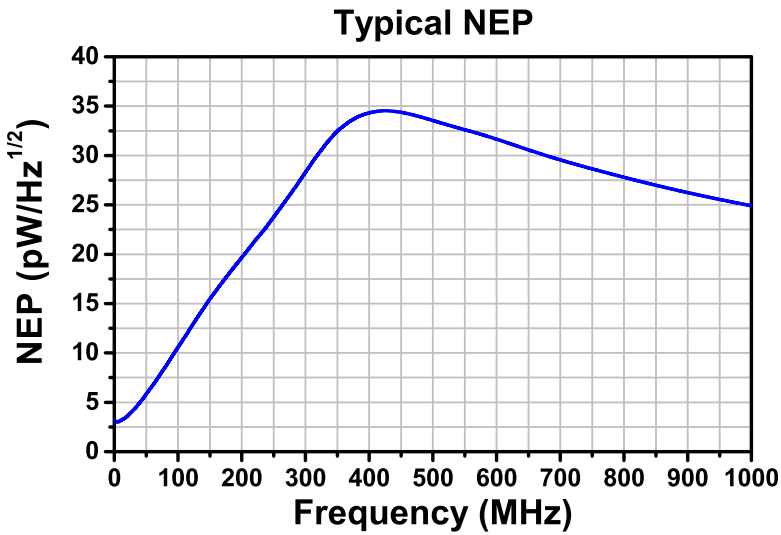

Figure 8. Typical Noise Spectrum for the PDA015A, Measured with a 50 Ω Load and 900 kHz Resolution Bandwidth

## 7.6. Noise Equivalent Power (NEP)

Each point on this curve was calculated by integrating the noise power from DC to the given frequency value and then dividing by the square root of that bandwidth. The NEP gives the amount of input power required to match the output noise level. The actual output noise level (in  $mV_{RMS}$ ) can be calculated by multiplying the data in this graph by the conversion gain and the square root of the bandwidth.



**Figure 9. Typical NEP for the PDA015A at the Maximum Responsivity Wavelength, Measured with a 50  $\Omega$  Load**

### 7.7. Mechanical Drawing

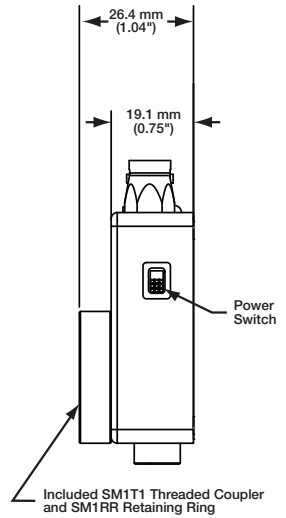
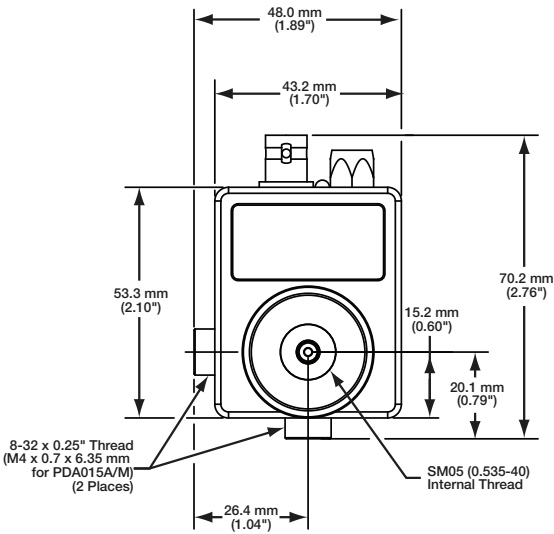
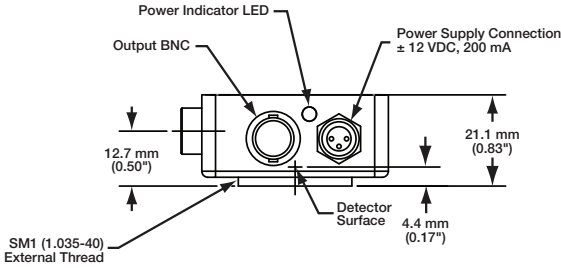

# Chapter 8 Certificate of Compliance



**THORLABS**  
www.thorlabs.com

## EU Declaration of Conformity

*in accordance with EN ISO 17050-1:2010*

We: Thorlabs Inc.  
Of: 56 Sparta Avenue, Newton, New Jersey, 07860, USA

*in accordance with the following Directive(s):*

|            |   |
|------------|---|
| 2014/35/EU | Low Voltage Directive (LVD)                               |
| 2014/30/EU | Electromagnetic Compatibility (EMC) Directive             |
| 2011/65/EU | Restriction of Use of Certain Hazardous Substances (RoHS) |

hereby declare that:  
 Model: **PDA015A, PDA015A/M, PDA015C, PDA015C/M**

Equipment: **Si & InGaAs Amplified Detectors**

*is in conformity with the applicable requirements of the following documents:*

|            |   |      |
|------------|---|------|
| EN 61010-1 | Safety Requirements for Electrical Equipment for Measurement, Control and Laboratory Use. | 2010 |
| EN 61326-1 | Electrical Equipment for Measurement, Control and Laboratory Use - EMC Requirements       | 2013 |

*and which, issued under the sole responsibility of Thorlabs, is in conformity with Directive 2011/65/EU of the European Parliament and of the Council of 8th June 2011 on the restriction of the use of certain hazardous substances in electrical and electronic equipment, for the reason stated below:*

does not contain substances in excess of the maximum concentration values tolerated by weight in homogenous materials as listed in Annex II of the Directive

*I hereby declare that the equipment named has been designed to comply with the relevant sections of the above referenced specifications, and complies with all applicable Essential Requirements of the Directives.*

Signed:  On: 20 January 2017

Name: Ann Strachan  
 Position: Compliance Manager

EDC - PDA015A, PDA015A/M, PDA015C, P...



## Chapter 9 Regulatory

As required by the WEEE (Waste Electrical and Electronic Equipment Directive) of the European Community and the corresponding national laws, Thorlabs offers all end users in the EC the possibility to return “end of life” units without incurring disposal charges.

- This offer is valid for Thorlabs electrical and electronic equipment:
- Sold after August 13, 2005
- Marked correspondingly with the crossed out “wheelie bin” logo (see right)
- Sold to a company or institute within the EC
- Currently owned by a company or institute within the EC
- Still complete, not disassembled and not contaminated

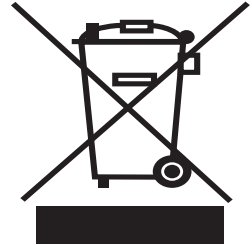

**Wheelie Bin Logo**

As the WEEE directive applies to self contained operational electrical and electronic products, this end of life take back service does not refer to other Thorlabs products, such as:

- Pure OEM products, that means assemblies to be built into a unit by the user (e.g. OEM laser driver cards)
- Components
- Mechanics and optics
- Left over parts of units disassembled by the user (PCB's, housings etc.).

If you wish to return a Thorlabs unit for waste recovery, please contact Thorlabs or your nearest dealer for further information.

### 9.1. Waste Treatment is Your Own Responsibility

If you do not return an “end of life” unit to Thorlabs, you must hand it to a company specialized in waste recovery. Do not dispose of the unit in a litter bin or at a public waste disposal site.

### 9.2. Ecological Background

It is well known that WEEE pollutes the environment by releasing toxic products during decomposition. The aim of the European RoHS directive is to reduce the content of toxic substances in electronic products in the future.

The intent of the WEEE directive is to enforce the recycling of WEEE. A controlled recycling of end of life products will thereby avoid negative impacts on the environment.

## Chapter 10 Thorlabs Worldwide Contacts

For technical support or sales inquiries, please visit us at [www.thorlabs.com/contact](http://www.thorlabs.com/contact) for our most up-to-date contact information.



### USA, Canada, and South America

Thorlabs, Inc.  
[sales@thorlabs.com](mailto:sales@thorlabs.com)  
[techsupport@thorlabs.com](mailto:techsupport@thorlabs.com)

### Europe

Thorlabs GmbH  
[europe@thorlabs.com](mailto:europe@thorlabs.com)

### France

Thorlabs SAS  
[sales.fr@thorlabs.com](mailto:sales.fr@thorlabs.com)

### Japan

Thorlabs Japan, Inc.  
[sales@thorlabs.jp](mailto:sales@thorlabs.jp)

### UK and Ireland

Thorlabs Ltd.  
[sales.uk@thorlabs.com](mailto:sales.uk@thorlabs.com)  
[techsupport.uk@thorlabs.com](mailto:techsupport.uk@thorlabs.com)

### Scandinavia

Thorlabs Sweden AB  
[scandinavia@thorlabs.com](mailto:scandinavia@thorlabs.com)

### Brazil

Thorlabs Vendas de Fotônicos Ltda.  
[brasil@thorlabs.com](mailto:brasil@thorlabs.com)

### China

Thorlabs China  
[chinasales@thorlabs.com](mailto:chinasales@thorlabs.com)





**THORLABS**  
[www.thorlabs.com](http://www.thorlabs.com)

---