



## HOBO RX3000 Remote Monitoring Station

Models: RX3001-00-01 Ethernet  
 RX3002-00-01 Wi-Fi  
 RX3003-00-01 Cellular  
 RX3004-00-01 Cellular 4G

### Included Items:

- Two plates for cable access openings with eight thumbscrews and one wrench
- Two rubber cable channels
- Rubber plugs
- Grease packet
- Two mounting plates with four screws
- Grounding wire
- Two U-bolts

### Required Items:

- HOBOLink
- HOBOWare® 3.7.2 or later with USB cable for RX3002 Wi-Fi models (optional for RX3001, RX3003, and RX3004 models)
- AC adapter (AC-U30) or solar panel (SOLAR-xW)

### Optional Items:

- Smart sensors
- Analog sensor module (RXMOD-A1)
- Relay module (RXMOD-R1)
- RXW Manager (RXMOD-RXW-xxx) and RXW motes
- Water level sensor module (RXMOD-W1) with water level sensor (MX2001-0x-SS-S or MX2001-0x-Ti-S) and cable (CABLE-RWLMOD-xxx)
- External DC power cable (CABLE-RX-PWR)
- Tripod kit (M-TPA or M-TPB)
- Guy wire kit (M-GWA)
- 1/2 inch stake kit (M-SKA)
- Grounding kit (M-GKA), required if using wind speed or wind direction smart sensor

Sensors, modules, and accessories are available at [www.onsetcomp.com](http://www.onsetcomp.com).

The HOBO RX3000 Remote Monitoring Station provides continuous logging for a broad range of energy and weather monitoring applications with up to ten smart sensors, optional analog sensor, water level sensor, and relay modules, and wireless sensor motes. Data from the RX3000 station is transferred at regular connection intervals to HOBOLink® web-based software where you can check the latest conditions, view graphs, configure sensors and alarms, set up a dashboard, download your data, or schedule data delivery via email or FTP. Inside its weatherproof enclosure, this durable station has a built-in LCD screen to check the current system configuration and status, start and stop logging, add and remove smart sensors, and connect to HOBOLink on demand. Up to three individual relays can be activated on the optional relay module while the optional analog module has four analog inputs that support excitation power, scaling, and statistics measurements. An optional RXW Manager module is also available for the station to set up the HOBONet Wireless Sensor Network, which can support up to 50 motes. All easy-to-install modules can be configured with HOBOLink.

## Specifications

<b>Operating Range</b>	-40° to 60°C (-40° to 140°F); no remote communications for battery voltage less than 3.9 V DC
<b>Smart Sensor Connectors</b>	10
<b>Smart Sensor Network Cable Length</b>	100 m (328 ft) maximum
<b>Smart Sensor Data Channels</b>	Maximum of 15 (some smart sensors use more than one data channel; see sensor manual for details)
<b>Module Slots</b>	2
<b>Logging Rate</b>	1 second (RX3001 and RX3002) or 1 minute (RX3003 and RX3004) to 18 hours
<b>Time Accuracy</b>	±8 seconds per month in 0° to 40°C (32°F to 104°F) range; ±30 seconds per month in -40° to 60°C (-40° to 140°F) range
<b>Battery Type/Power Source</b>	4 Volt, 10 Ahr, rechargeable sealed lead-acid; external power required using one of these options: AC power adapter (AC-U30), solar panel (SOLAR-xW), or external power source 5 V DC to 17 V DC with external DC power cable (CABLE-RX-PWR)
<b>Rechargeable Battery Service Life</b>	Typical 3–5 years when operated in the temperature range -20° to 40°C (-4°F to 104°F); operation outside this range will reduce the battery service life
<b>Memory</b>	32 MB, 2 million measurements, continuous logging
<b>Alarm Notification Latency</b>	Logging interval plus 2–4 minutes, typical
<b>Enclosure Access</b>	Hinged door secured by two latches with eyelets for use with user-supplied padlocks
<b>LCD</b>	LCD is visible from 0° to 50°C (32° to 122°F); the LCD may react slowly or go blank in temperatures outside this range
<b>Materials</b>	Outer enclosure: Polycarbonate/PBT blend with stainless steel hinge pins and brass inserts; Inner enclosure: Polycarbonate; Gaskets: Silicone rubber; Cable channel: EPDM rubber; Cable opening cover: Aluminum with ABS plastic thumb screws; U-Bolts: Steel with zinc dichromate finish
<b>Size</b>	18.6 x 18.1 x 11.8 cm (7.3 x 7.1 x 4.7 in.); see diagrams on next page
<b>Weight</b>	2.2 kg (4.85 lb)
<b>Mounting</b>	3.8 cm (1.5 inch) mast or wall mount
<b>Environmental Rating</b>	Weatherproof enclosure, NEMA 4X (requires proper installation of cable channel system)
<b>CE</b>	The CE Marking identifies this product as complying with all relevant directives in the European Union (EU)
<b>FC</b>	See last page.
<b>RX3002:</b>	FCC ID R68XPICOW, IC ID 3867A-XPICOW
<b>RX3003:</b>	FCC ID QIPEHS6, IC ID 7830A-EHS6; approved for use in Taiwan and Japan
<b>RX3004:</b>	FCC ID QIPPLS62-W, IC ID:7830A-PLS62W
<b>RX3004:</b>	FCC ID QIPPLS63-W, ISED ID:7830A-PLS63W; approved for use in Japan

## Table of Contents

Specifications .....	1	Setting up a Water Level Channel .....	19
Module Specifications .....	3	Setting up a Water Flow Channel for a V-Notch Weir .....	20
Device Components and Operation .....	6	Setting up a Water Flow Channel for a Rectangular Weir .....	21
LCD Operation .....	7	Setting up a Water Flow Channel for a Trapezoidal Weir.....	22
Setting up the Station .....	9	Setting up a Water Flow Channel for a General Flume .....	22
1. Log in to HOBOLink .....	9	Setting up a Water Flow Channel for a Stage-Discharge Table.....	23
2. Register the station .....	9	Starting and Stopping Logging .....	24
3. Install optional modules or user-supplied SIM .....	9	Adding or Removing Smart Sensors.....	24
4. Plug in the battery and charging device .....	9	Adding or Removing Modules.....	24
5. Check and configure device communications .....	10	Adding or Removing Analog Sensors, Relay Devices, or Water Level Sensors .....	25
6. Plug in and search for any smart sensors.....	11	Adding or Removing Motes .....	25
7. Add any wireless sensor motes .....	11	Managing Connections to HOBOLink.....	27
8. Connect analog sensors, relay devices, or water level sensors..	12	Checking Latest Conditions with HOBOWare .....	27
9. Connect to HOBOLink .....	13	Deploying and Mounting the Station.....	27
10. Configure the station in HOBOLink .....	13	Guidelines for Deploying the Station.....	27
11. Start logging.....	17	Guidelines for Deploying the HOBONet RX Wireless Sensor Network.....	28
12. If you installed a water level sensor module and sensor, obtain a reference water level reading.....	17	Guidelines for Deploying a Water Level Sensor .....	29
13. If you installed a water level sensor module and sensor, configure the water level and water flow channels in HOBOLink.....	17	Installing the Grounding Wire .....	29
Viewing Data in HOBOLink.....	18	Mounting the Station .....	29
Setting System and Sensor Alarms.....	18	Installing the Weatherproof Rubber Cable Channel and Covers .....	30
System Alarms.....	18	Care and Maintenance.....	31
Sensor Alarms.....	19	Troubleshooting.....	31
Setting up Water Level and Water Flow Channels in HOBOLink .....	19	Battery Information .....	31

## Specifications (continued)

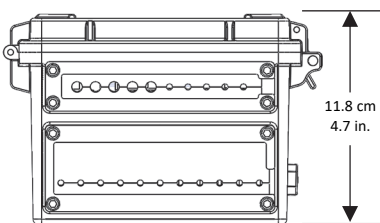
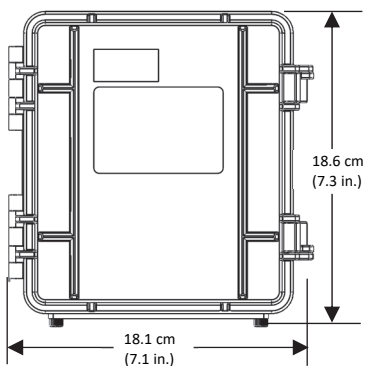

Dimensions

### Ethernet (RX3001)

Connector	One RJ45/100BaseT
-----------	-------------------

### Wi-Fi (RX3002)

Network Standards	IEEE 802.11b/g/n
Frequency Range	2.412–2.484 GHz
Antenna Connector	1, no diversity supported
Data Rates	1, 2, 5.5, 11 Mbps (802.11b); 6, 9, 12, 18, 24, 36, 48, 54 Mbps (802.11g); 802.11n, HT20 MCS0 (6.5 Mbps) to HT20 MC87 (65 Mbps)
Number of Selectable Radio Subchannels	Up to 14 channels; profiles available will include USA, France, Japan, Spain, Canada, and “Other” (multiple countries)
Radio Modulations	OFDM, DSSS, DBPSK, DQPSK, CCK, 16QAM, 64QAM
Security	WEP 64/128, WPA-PSK, AES end-to-end encryption, WPA2, protocols not listed are not supported
Maximum Receive Level	-10 dBm (with PER <8%)
Receiver Sensitivity	-72 dBm for 54 Mbps, -87 dBm for 11 Mbps, -89 dBm for 5.5 Mbps, -90 dBm for 2.0 Mbps, -92 dBm for 1.0 Mbps

### Cellular (RX3003 and RX3004)

Wireless Radio	<b>RX3003:</b> GSM/GPRS/EDGE: Quad band 850/900/1800/1900 MHz, UMTS/HSPA+: Five band 800/850/900/1900/2100 MHz  <b>RX3004:</b> GSM/GPRS/EDGE: Quad band 850/900/1800/1900 MHz UMTS/HSPA+: Seven band 800/850/900/1800/1900/2100 MHz LTE: Twelve Band 700/800/850/900/1800/1900/2100/2600 MHz
Antenna	<b>RX3003:</b> Penta band <b>RX3004:</b> 4G LTE

## Module Specifications

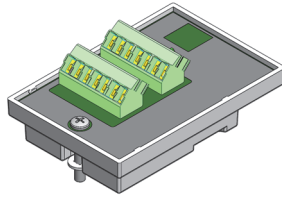

Analog Sensor Module (RXMOD-A1)

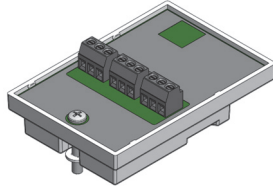

Relay Module (RXMOD-R1)

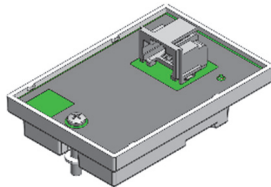

RXW Manager Module (RXMOD-RXW-xxx)





### Optional Analog Sensor Module (RXMOD-A1)

<b>Input Channels</b>	Four, single-ended, in addition to smart sensor data channels
<b>Measurement Range and Accuracy</b>	0–25.6 mA DC, $\pm 5 \mu\text{A} \pm 0.15\%$ of reading 0–2.5 V DC, $\pm 0.25 \text{ mV} \pm 0.2\%$ of reading 0–5 V DC, $\pm 0.25 \text{ mV} \pm 0.2\%$ of reading 0–10 V DC, $\pm 0.3 \text{ mV} \pm 0.2\%$ of reading 0–20 V DC, $\pm 0.6 \text{ mV} \pm 0.2\%$ of reading 0–33 V DC, $\pm 1.20 \text{ mV} \pm 0.2\%$ of reading
<b>Resolution</b>	15 bits
<b>Field Wiring</b>	Two- or three-wire via screw terminals, 16–24 AWG
<b>Minimum/Maximum Input Voltage</b>	0/33 V DC
<b>Minimum/Maximum Input Current</b>	0/25.6 mA
<b>Minimum Source Impedance for Current Measurement</b>	20 k $\Omega$
<b>Excitation Voltage</b>	12 V DC $\pm 5\%$ at 200 mA maximum per module

### Optional Relay Module (RXMOD-R1)

<b>Relays</b>	Three independent relays
<b>Alarm Output Relays</b>	Each relay contact closure can be configured as normally open, normally closed, or pulsed for one second
<b>Voltage</b>	30 V max
<b>Current</b>	1 Amp max

### Optional RXW Manager Module (RXMOD-RXW-xxx)

<b>Operating Temperature Range</b>	-25° to 60°C (-13° to 140°F)
<b>Radio Power</b>	12.6 mW (+11 dBm) non-adjustable
<b>Transmission Range</b>	At least 304.8 m (1,000 ft) line of sight at 1.8 m (6 ft) from the ground, 457.2 m (1,500 ft) typical
<b>Wireless Data Standard</b>	IEEE 802.15.4
<b>Radio Operating Frequencies</b>	RXMOD-RXW-900: 904–924 MHz RXMOD-RXW-868: 866.5 MHz RXMOD-RXW-921: 921 MHz RXMOD-RXW-922: 916–924 MHz
<b>Modulation Employed</b>	OQPSK (Offset Quadrature Phase Shift Keying)
<b>Data Rate</b>	Up to 250 kbps, non-adjustable
<b>Duty Cycle</b>	<1%
<b>Maximum Number of Motes</b>	Up to 50 wireless sensors or 336 data channels per one HOBO RX station
<b>Power Source</b>	Powered by the RX3000 station
<b>Dimensions</b>	Mote: 16.2 x 8.59 x 4.14 cm (6.38 x 3.38 x 1.63 inches) Cable length: 2 m (6.56 ft)
<b>Weight</b>	Mote: 159 g (5.62 oz)
<b>Materials</b>	Mote: PCPBT, silicone rubber seal
<b>Environmental Rating</b>	Mote: IP67
<b>Compliance Marks</b>	<p> RXMOD-RXW-900: See last page</p> <p> RXMOD-RXW-868: The CE Marking identifies this product as complying with all relevant directives in the European Union (EU).</p> <p> RXMOD-RXW-921: See last page</p> <p> RXMOD-RXW-922: See last page</p>

## Module Specifications (continued)

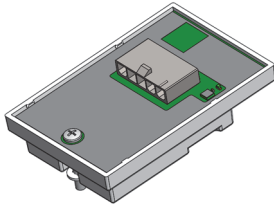

Water Level Sensor Module  
(RXMOD-W1)

## Optional Water Level Sensor Module (RXMOD-W1)

## Pressure (Absolute) and Water Level Measurements MX2001-01-SS-S and MX2001-01-Ti-S

<b>Operation Range</b>	0 to 207 kPa (0 to 30 psia); approximately 0 to 9 m (0 to 30 ft) of water depth at sea level, or 0 to 12 m (0 to 40 ft) of water at 3,000 m (10,000 ft) of altitude
<b>Factory Calibrated Range</b>	69 to 207 kPa (10 to 30 psia), 0° to 40°C (32° to 104°F)
<b>Burst Pressure</b>	310 kPa (45 psia) or 18 m (60 ft) depth
<b>Water Level Accuracy*</b>	Typical error: $\pm 0.05\%$ FS, 0.5 cm (0.015 ft) water Maximum error: $\pm 0.1\%$ FS, 1.0 cm (0.03 ft) water
<b>Raw Pressure Accuracy**</b>	$\pm 0.3\%$ FS, 0.62 kPa (0.09 psi) maximum error
<b>Resolution</b>	<0.02 kPa (0.003 psi), 0.21 cm (0.007 ft) water
<b>Pressure Response Time (90%***)</b>	<1 second at a stable temperature

## Pressure (Absolute) and Water Level Measurements MX2001-02-SS-S

<b>Operation Range</b>	0 to 400 kPa (0 to 58 psia); approximately 0 to 30.6 m (0 to 100 ft) of water depth at sea level, or 0 to 33.6 m (0 to 111 ft) of water at 3,000 m (10,000 ft) of altitude
<b>Factory Calibrated Range</b>	69 to 400 kPa (10 to 58 psia), 0° to 40°C (32° to 104°F)
<b>Burst Pressure</b>	500 kPa (72.5 psia) or 40.8 m (134 ft) depth
<b>Water Level Accuracy*</b>	Typical error: $\pm 0.05\%$ FS, 1.5 cm (0.05 ft) water Maximum error: $\pm 0.1\%$ FS, 3.0 cm (0.1 ft) water
<b>Raw Pressure Accuracy**</b>	$\pm 0.3\%$ FS, 1.20 kPa (0.17 psi) maximum error
<b>Resolution</b>	<0.04 kPa (0.006 psi), 0.41 cm (0.013 ft) water
<b>Pressure Response Time (90%***)</b>	<1 second at a stable temperature

## Pressure (Absolute) and Water Level Measurements MX2001-03-SS-S

<b>Operation Range</b>	0 to 850 kPa (0 to 123.3 psia); approximately 0 to 76.5 m (0 to 251 ft) of water depth at sea level, or 0 to 79.5 m (0 to 262 ft) of water at 3,000 m (10,000 ft) of altitude
<b>Factory Calibrated Range</b>	69 to 850 kPa (10 to 123.3 psia), 0° to 40°C (32° to 104°F)
<b>Burst Pressure</b>	1,200 kPa (174 psia) or 112 m (368 ft) depth
<b>Water Level Accuracy*</b>	Typical error: $\pm 0.05\%$ FS, 3.8 cm (0.125 ft) water Maximum error: $\pm 0.1\%$ FS, 7.6 cm (0.25 ft) water
<b>Raw Pressure Accuracy**</b>	$\pm 0.3\%$ FS, 2.55 kPa (0.37 psi) maximum error
<b>Resolution</b>	<0.085 kPa (0.012 psi), 0.87 cm (0.028 ft) water
<b>Pressure Response Time (90%***)</b>	<1 second at a stable temperature

## Pressure (Absolute) and Water Level Measurements MX2001-04-SS-S and MX2001-04-Ti-S

<b>Operation Range</b>	0 to 145 kPa (0 to 21 psia); approximately 0 to 4 m (0 to 13 ft) of water depth at sea level, or 0 to 7 m (0 to 23 ft) of water at 3,000 m (10,000 ft) of altitude
<b>Factory Calibrated Range</b>	69 to 145 kPa (10 to 21 psia), 0° to 40°C (32° to 104°F)
<b>Burst Pressure</b>	310 kPa (45 psia) or 18 m (60 ft) depth
<b>Water Level Accuracy*</b>	Typical error: $\pm 0.075\%$ FS, 0.3 cm (0.01 ft) water Maximum error: $\pm 0.15\%$ FS, 0.6 cm (0.02 ft) water
<b>Raw Pressure Accuracy**</b>	$\pm 0.3\%$ FS, 0.43 kPa (0.063 psi) maximum error
<b>Resolution</b>	<0.014 kPa (0.002 psi), 0.14 cm (0.005 ft) water
<b>Pressure Response Time (90%***)</b>	<1 second at a stable temperature

Module Specifications (continued)

Water Level Sensor and Cable

<b>Dimensions</b>	Sensor (MX2001-0x-SS-S and MX2001-0x-Ti-S): 2.54 cm (1.0 inches) diameter, 9.91 cm (3.9 inches) length Cable (CABLE-RWLMOD-xxx): 0.47 cm ±0.03 (0.185 inches ±0.01) diameter, 0.2 to 400 m (0.65 to 1,312 ft) length <b>Note:</b> The length of the water level logger cable can vary -0% to +3% +10 cm (3.9 inches) from the length ordered.
<b>Weight</b>	Stainless sensor (MX2001-0x-SS-S): Approximately 141.4 g (4.99 oz) in air; approximately 93.4 g (3.3 oz) in fresh water Titanium sensor (MX2001-0x-Ti-S): Approximately 80 g (2.83 oz) in air; approximately 37 g (1.3 oz) in fresh water Cable (CABLE-RWLMOD-xxx): 39 g (1.38 oz) per 1 meter (3.28 ft)
<b>Materials</b>	Stainless sensor (MX2001-0x-SS-S): Stainless steel housing, Viton and Buna-N O-rings, ceramic sensor in stainless steel end cap Titanium sensor (MX2001-0x-Ti-S): Acetal housing, Viton and Buna-N O-rings, ceramic sensor in Titanium end cap Cable (CABLE-RWLMOD-xxx): Polycarbonate top end connector, PVC end cap (sensor connection), nylon collar nuts, Viton O-rings, polyurethane jacket
<b>Environmental Rating</b>	IP68; cable is waterproof for continuous immersion up to 112 m (368 ft), refer to sensor model specifications for sensor depth rating

Barometric Pressure (RXMOD-W1)

<b>Operation Range</b>	66 to 107 kPa (9.57 to 15.52 psia)
<b>Temperature Calibrated Range</b>	-20° to 50°C (-4° to 122°C)
<b>Accuracy</b>	±0.2 kPa (±0.029 psi) over full temperature range at fixed pressure; maximum error ±0.5% FS
<b>Water Level Accuracy*</b>	Typical error: ±0.075% FS, 0.3 cm (0.01 ft) water Maximum error: ±0.15% FS, 0.6 cm (0.02 ft) water
<b>Resolution</b>	<0.01 kPa (0.0015 psi)
<b>Response Time</b>	<1 second at stable temperature
<b>Stability (Drift)</b>	<0.01 kPa (0.0015 psi) per year

Temperature (Water Level Sensors MX2001-0x-SS-S and MX2001-0x-Ti-S)

<b>Operation Range</b>	-20° to 50°C (-4° to 122°F)
<b>Accuracy</b>	±0.44°C from 0° to 50°C (±0.79°F from 32° to 122°F), see Plot A
<b>Resolution</b>	0.1°C at 25°C (0.18°F at 77°F), see Plot A
<b>Response Time (90%)</b>	5 minutes in water (typical)
<b>Stability (Drift)</b>	0.1°C (0.18°F) per year

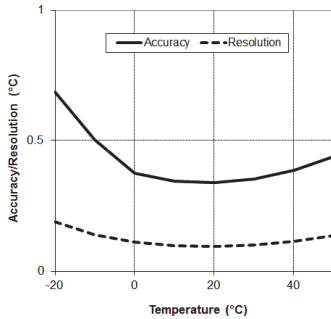

Plot A

- \* Water Level Accuracy: With accurate reference water level measurement, known water density, and a stable temperature environment. System Water Level Accuracy equals the sum of the Barometric Water Level Accuracy plus the selected sensor Water Level Accuracy.
- \*\* Raw Pressure Accuracy: Absolute pressure sensor accuracy includes all sensor drift, temperature, and hysteresis-induced errors.
- \*\*\* Changes in Temperature: Allow 20 minutes in water to achieve full temperature compensation of the pressure sensor. There can be up to 0.5% of additional error due to rapid temperature changes. Measurement accuracy also depends on temperature response time.

## Device Components and Operation

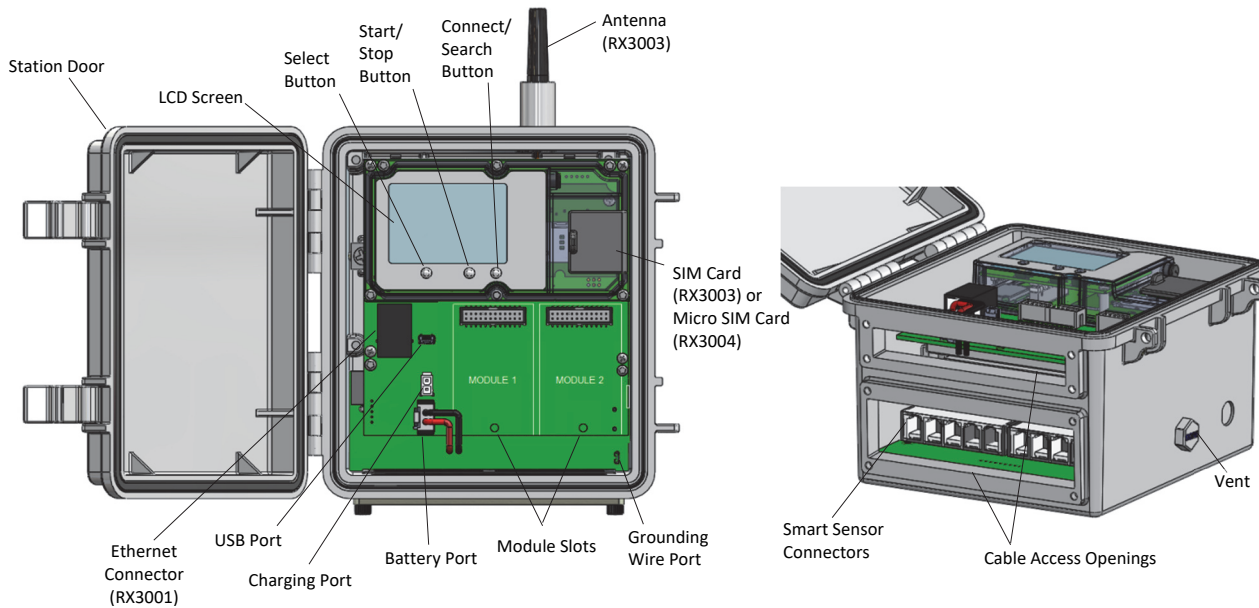

**Station Door:** This is the protective, hinged door covering the LCD and electronics. The station serial number and device key needed for HOBOLink registration are located on the inside of the door.

**LCD Screen:** This shows details about system, module, and sensor operation (see *LCD Operation*).

**Select Button:** Use this button to cycle through information about the smart sensors and optional modules (see *LCD Operation*).

**Start/Stop Button:** Use this button to start and stop logging or clear a fault code (see *LCD Operation*).

**Connect/Search Button:** Use this button to connect to HOBOLink or search for new smart sensors (see *LCD Operation*).

**Antenna:** This is the external radio antenna for cellular communication in the RX3003 model. The RX3002 and RX3004 models use an internal antenna.

**SIM Card/Micro SIM Card:** A SIM card is installed in the RX3003 model or a micro SIM card is installed in the RX3004 model to enable cellular communications.

**Grounding Wire Port:** Use this port to connect a grounding wire (see *Deploying and Mounting the Station*).

**Module Slots:** These are two slots for installing optional analog sensor, relay, water level sensor, or RXW Manager modules (see *Setting up the Station*).

**Battery Port:** Use this port to plug in the internal battery cable (see *Setting up the Station* and *Battery Information*).

**Charging Port:** Use this port to plug in an AC adapter, solar panel, or external power source to keep the battery charged (see *Setting up the Station* and *Battery Information*).

**USB Port:** Use this port to connect the station to the computer via USB cable as needed for HOBOWare.

**Ethernet Connector:** Use this port to connect an Ethernet RJ45 cable for the RX3001 model (see *Setting up the Station*).

**Smart Sensor Connectors:** Use these input jacks to connect up to 10 smart sensors (see *Setting up the Station*). The station can support up to 15 smart sensor data channels; some smart sensors have more than one data channel.

**Cable Access Openings:** These are the two openings for connecting cables and wires to the station (see *Setting up the Station*). Install the cover plates and rubber cable channels in these openings to create a weatherproof seal (see *Deploying and Mounting the Station*).

**Vent.** This vent allows pressure to equalize inside the station while keeping water out. Note that the pressure inside the station does not match the outside air pressure exactly. Therefore, a barometric pressure sensor deployed within the case cannot measure the true atmospheric pressure unless it has its own unrestricted vent to the outside.

## LCD Operation

This example shows all symbols illuminated on the LCD screen with an overview of what each section of the LCD represents. Refer to the table below for details about each section and associated symbols.

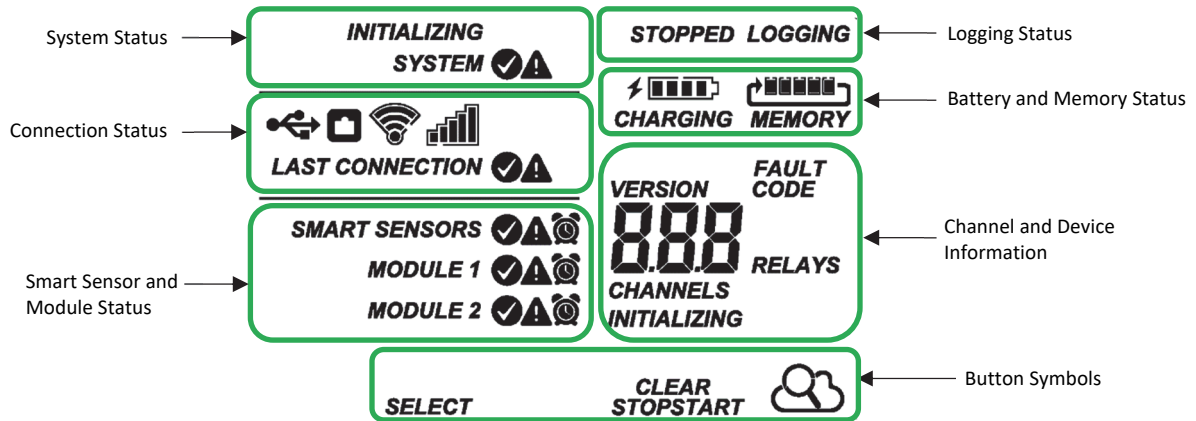

<p><b>System Status</b></p> <p><b>SYSTEM</b> or <b>INITIALIZING SYSTEM</b></p>	<p>This part of the LCD shows the overall system status.</p> <p>When the station is powered up, "Initializing System" flashes in the upper left part of the LCD. After initialization is complete, "System" remains illuminated and one of these symbols will appear:</p> <ul style="list-style-type: none"> <li>✓ indicates the system is ok.</li> <li>⚠ indicates there is a problem with the system; check the Device Information panel on your station page in HOBOLink.</li> </ul>
<p><b>Connection Status</b></p> <p><b>CONNECTION</b> or <b>LAST CONNECTION</b></p>	<p>This part of the LCD shows the communication method used for connecting to HOBOLink and the system connection status.</p> <ul style="list-style-type: none"> <li> This indicates the station is connected via a USB cable.</li> <li> This indicates the station is using Ethernet to connect to HOBOLink. This will blink while connecting to HOBOLink.</li> <li> This indicates the station is using Wi-Fi to connect to HOBOLink. This also shows the strength of the wireless signal; the more bars there are, the stronger the signal. This will blink while connecting to HOBOLink.</li> <li> This indicates the station is using a cellular network to connect to HOBOLink. This also shows the strength of the cellular signal; the more bars there are, the stronger the signal. This will blink while connecting to HOBOLink.</li> </ul> <p>When the station is attempting to connect or is currently connected to HOBOLink, "Connection" flashes on the LCD. After the connection is complete, "Last Connection" remains illuminated and one of these symbols will appear:</p> <ul style="list-style-type: none"> <li>✓ indicates the last connection to HOBOLink was ok.</li> <li>⚠ indicates there was a problem with the last connection; check the Connections log in HOBOLink.</li> </ul>
<p><b>Smart Sensor and Module Status</b></p> <p><b>SMART SENSORS</b> <b>MODULE 1</b> <b>MODULE 2</b></p>	<p>This part of the LCD shows the status of the smart sensors and any optional modules installed. Module 1 is installed in the left slot and Module 2 in the right slot.</p> <p>One of the following symbols will also appear next to smart sensors or a module (if applicable):</p> <ul style="list-style-type: none"> <li>✓ indicates the smart sensor or module is ok.</li> <li>⚠ indicates there is a problem with the smart sensor or module; check your device page in HOBOLink.</li> <li>🔔 indicates a sensor alarm has tripped and will flash on the LCD until the alarm is cleared; check the Alarms log in HOBOLink.</li> </ul>
<p><b>Logging Status</b></p> <p><b>STOPPED</b> or <b>LOGGING</b></p>	<p>This part of the LCD indicates whether the station is currently logging.</p> <p>"Stopped" indicates the station is not currently logging while "Logging" indicates it is currently logging. Press the Start/Stop button to start or stop logging as desired. Note that "Logging" will blink until the first data point is logged after the Start button is pressed.</p>
<p><b>Battery and Memory Status</b></p> <p> or  <b>CHARGING</b> or  <b>MEMORY</b></p>	<p>This part of the LCD shows the current battery level and memory.</p> <p>The battery indicator shows the approximate battery power remaining. In this example, the battery is fully charged. The lightning bolt will appear when an AC adapter, solar panel, or external power source is plugged into the station. "Charging" will flash while the battery is being charged.</p> <p>When the station is logging, it will record data indefinitely, with newest data overwriting the oldest data until the station is stopped. This continuous logging is represented by the arrow in this symbol.</p>

**Channel and Device Information**

This part of the LCD shows the number of channels and other information about each module. It also shows general device information. Press the Select button to scroll through four screens: the main screen, smart sensors screen, Module 1, and Module 2 screens.

12  
CHANNELS  
or  
000 RELAYS

**Main Screen**

When viewing the main LCD screen, the total number of channels in use by the system is displayed. This is a combination of smart sensor channels and enabled sensor channels. For example, if there are 5 smart sensor channels and 3 analog sensor channels, then 8 channels are shown on the main screen, as in the following example.

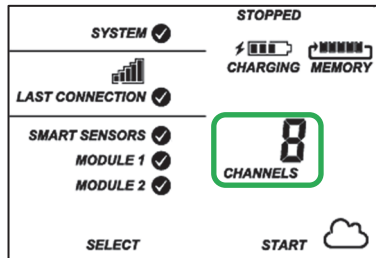

**Smart Sensors Screen**

When viewing the smart sensors screen, the number of smart sensor channels is displayed. Note that some smart sensors have more than one channel associated with them so the number of channels may not match the number of physical smart sensors. In this example, there are 5 smart sensor channels.

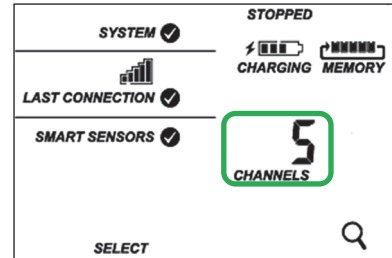

**Module 1 and 2**

When viewing the Module 1 or Module 2 screen, information about that particular module is displayed. If an analog sensor module is installed, the number of enabled analog sensors is displayed in the channels count (three sensors in this example). If an RXW Manager module is installed, the channel count represents all measurement channels plus a battery channel for each mote in the HOBONet RX Wireless Sensor Network. For example, one temp/RH wireless sensor has a channel count of three as shown below: two for temperature and RH and one for the mote battery.

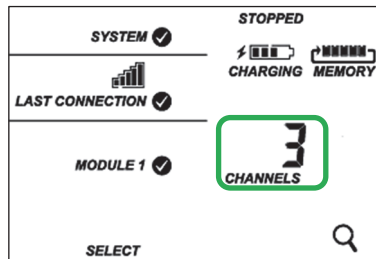

When a relay module is installed, the state of each relay is shown on the module screen. In this example, a relay module is installed in the Module 2 slot so this shows whether each relay is open "o" or closed "c". In this example, the first and third relays are open, and the second one is closed.

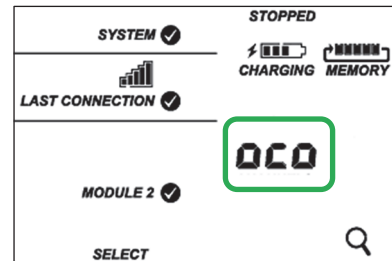

If a water level sensor module is installed, the channel count is listed as 4. This represents barometric pressure, water pressure, differential pressure, and water temperature. Water level and water flow channels are derived in HOBOLink and not included in the channel count shown on the station LCD.

**INITIALIZING**

014  
FAULT CODE  
VERSION  
108

This will blink in the lower right part of the LCD when a firmware update is underway. It will display which module or element is being updated.

This is a numerical code that appears when a system fault has occurred. You may need to provide this code to Onset Technical Support. See *Troubleshooting* for details.

This is the version number of the station firmware. It only appears when powering up the device.

**Button Symbols**

Use the three buttons below the following symbols to operate the station. Press any of the three buttons to turn on the LCD.

**SELECT**  
**START**  
**STOP**

Press this button to cycle through status information about the smart sensors and two optional modules.

Press this button to start logging. This option is not available while the station is actively connected to HOBOLink.

Press this button to stop logging. This option is not available while the station is actively connected to HOBOLink.



Press this button to connect to HOBOLink. This option is only available on the main LCD screen. It is not available when scrolling through smart sensor and module information with the Select button. In addition, this option is not available while a connection is underway or active.



Press this Search button for the station to detect all currently installed smart sensors or to add motes to your HOBONet RX Wireless Sensor Network. As you add or remove smart sensors while the station is stopped, press the Select button and then the Search button for the system to recognize your changes. This option is not available for smart sensors while the station is logging. To add motes to the HOBONet RX Wireless Sensor Network, press the Select button to switch to the module for the RXW Manager and then press the Search button for the station to find the motes. The station can search for motes whether it is logging or stopped.

**CLEAR**

Use this button to clear a fault code.



**Notes on LCD Operation:**

- The LCD will turn off after 5 minutes of inactivity. Press any button to turn the LCD back on.
- There can be a delay before the LCD updates. For example, if you plug in an AC adapter, it may take a few seconds before the lightning bolt icon appears on the LCD. This delay is by design to preserve battery life.

**Setting up the Station**

Follow these steps to set up the station.

**1. Log in to HOBOLink.**

Go to [www.hobolink.com](http://www.hobolink.com) and log in to an existing account or create a new one. You'll receive an email to activate the new account.

**2. Register the station.**

In HOBOLink, click Devices, RX Devices, and then the Register a Device link. Give the station a name and enter the serial number and device key from the label inside the station door.

**3. Install optional modules or user-supplied SIM.**

- Make sure the station is powered down (unplug any charging device and then disconnect the battery).
- Insert the connector on the back of the module into the receptacle in the left or right module slot. Add a second module to the other slot if desired.

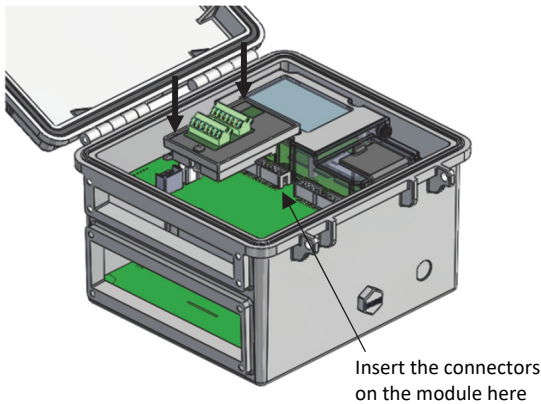

**Tip:** Install the analog module, water level sensor, or RXW Manager module on the left and the relay module on the right for easier cable routing.

- Using a Phillips-head screwdriver, tighten the screw at the bottom of each module. In this example, an analog module is installed in the Module 1 slot and a relay module is installed in the Module 2 slot.

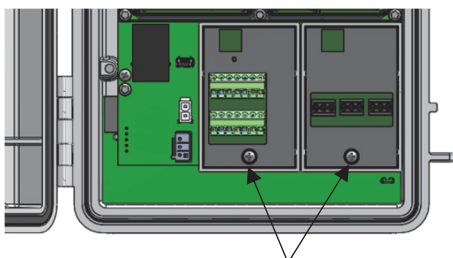

Tighten the screw on installed modules

**If you installed an RXW Manager module:**

Plug the cable from the RXW Manager mote into the jack on the module, making sure the cable is inserted through the bottom of the station case. Do not reconnect the power on the station until the mote is plugged in as shown.

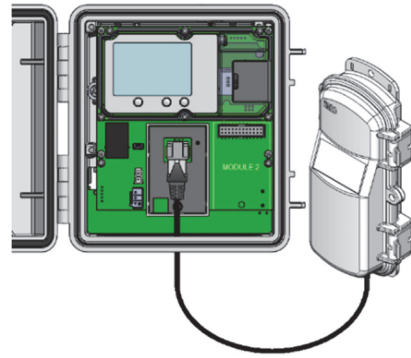

**WARNING:** If you inadvertently install modules while the power is on, you must disconnect and then reconnect the battery and charging device to guarantee proper operation.

**If you are installing your own SIM:**

Before continuing, follow the instructions at [www.onsetcomp.com/resources/documentation/19051-installing-sim-rx3000-station](http://www.onsetcomp.com/resources/documentation/19051-installing-sim-rx3000-station).

**4. Plug in the battery and charging device.**

- Plug in the battery cable.
- Feed the AC adapter or solar panel cable through the smaller of the two cable openings and plug it in. You can also use an optional external DC power cable (CABLE-RX-PWR) with your own powering device in place of the AC adapter or solar panel.

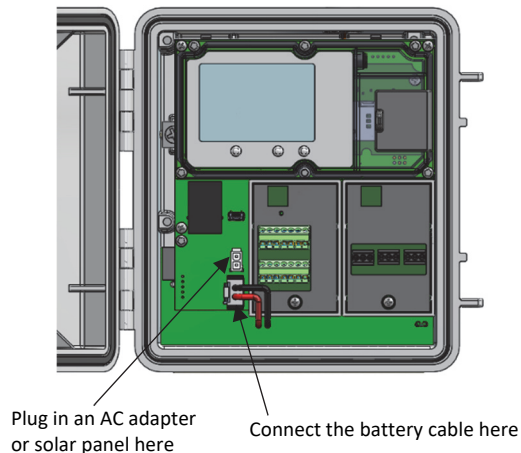

- c. Once the battery cable is plugged in, “Initializing System” will flash on the LCD. A checkmark appears next to “System” after the station initialization is complete.

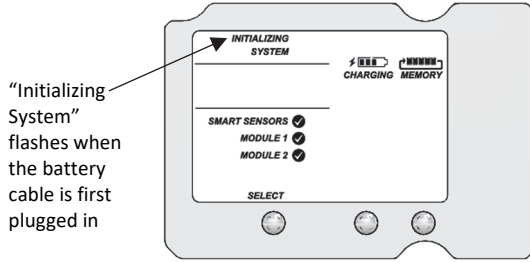

**5. Check and configure device communications.**

**For RX3003 and RX3004 cellular models:**

After the station powers up in the previous step, it will connect to HOBOLink automatically within two minutes. The cellular icon and “Connection” will flash while the connection is underway. Once the connection is complete, a checkmark appears next to Last Connection. Note that the entire initialization process may take several minutes; wait until Last Connection and the checkmark appears before continuing to step 6.

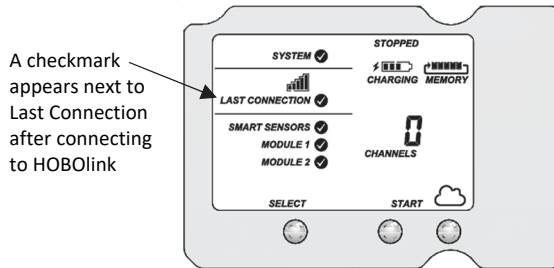

- d. In the RX Station Manager, click the Actions button and select Network Access.
- e. Deselect the Use DHCP checkbox.

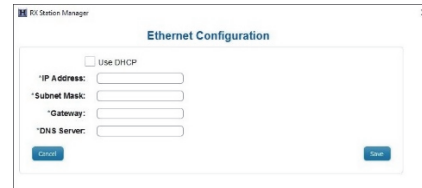

- f. Enter the IP Address, Subnet Mask, Gateway, and DNS Server. Consult your Network Administrator for the appropriate addresses to complete these fields.
- g. Click Save in the RX Station Manager. Click Done and then close the RX Station Manager.
- h. Disconnect the USB cable.
- i. Press the Connect button on the station (the cloud should be visible on the LCD screen) to connect to HOBOLink. The Ethernet icon and “Connection” will flash while the connection is underway. Once the connection is complete, a checkmark appears next to Last Connection. Wait for the checkmark and then continue to step 6.

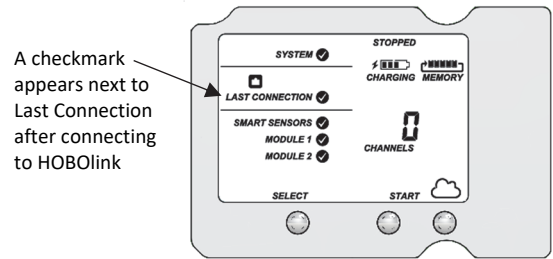

**For RX3001 Ethernet models:**

- a. Plug in an Ethernet cable.

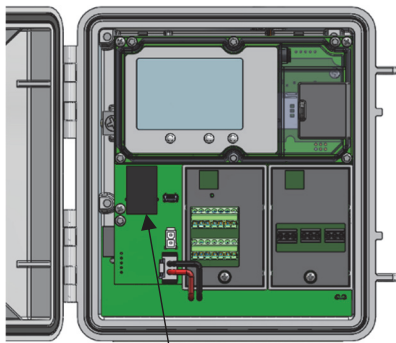

- b. The station uses DHCP by default. If your network uses DHCP, skip to step i.

If your network uses static IP addresses, connect the station to the computer with the USB cable. (Consult your Network Administrator if you are unsure whether your network uses static IP addresses or for help with the following steps).

- c. In HOBOWare, select Manage RX Station from the Device menu. (On a computer with Microsoft® Windows®, you may see a warning that Windows Firewall has blocked some features. Select Domain networks and click Allow Access.)

**For RX3002 Wi-Fi models:**

- a. Connect the station to the computer with the USB cable.
- b. In HOBOWare, select Manage RX Station from the Device menu. (On a computer with Microsoft® Windows®, you may see a warning that Windows Firewall has blocked some features. Select Domain networks and click Allow Access.)
- c. In the RX Station Manager, click the Actions button and select Network Access.
- d. Enter the Security information for your Wi-Fi network. Type the Network Name, select the Security Type, and type the Security Key. Select the Hide characters checkbox to hide any characters typed into the Security Key field. Consult your Network Administrator or wireless router documentation for help with determining your network security type.



- e. The station uses DHCP by default. If your network uses DHCP, skip this step.

If your network uses static IP addresses, deselect the Use DHCP checkbox. Enter the IP Address, Subnet Mask, Gateway, and DNS Server. Consult your Network Administrator if you are unsure whether your network uses static IP addresses or for the appropriate addresses to enter in this fields.

- f. Click Save in the RX Station Manager. Click Done and then close the RX Station Manager.
- g. Disconnect the USB cable.
- h. Press the Connect button on the station (the cloud should be visible on the LCD screen) to connect to HOBOLink. The Wi-Fi icon and "Connection" will flash while the connection is underway. Once the connection is complete, a checkmark appears next to Last Connection. Wait for the checkmark and then continue to step 6.

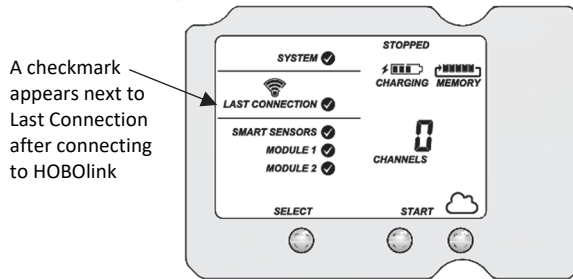

**6. Plug in and search for any smart sensors.**

**Important:** If this RX3000 station is a replacement for an existing U30 station, it is imperative that you power down the U30 station being replaced (disconnect the battery and AC adapter or solar panel) before you remove the smart sensors and connect them to the RX3000. Do not repower the U30 station or allow it to connect to HOBOLink again unless at least one different smart sensor is connected to the U30 station first.

- a. Feed the smart sensor cable for one smart sensor through the larger of the two cable openings and plug it into one of the 10 smart sensor connectors. Repeat for any additional smart sensors.

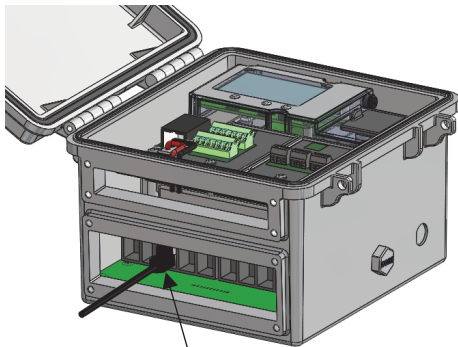

- b. Press the Select button to view the smart sensors on the LCD and then press the Search button (the magnifying glass icon should be visible as in the following example). The station will search for all connected smart sensors and show the number of channels after a few seconds.

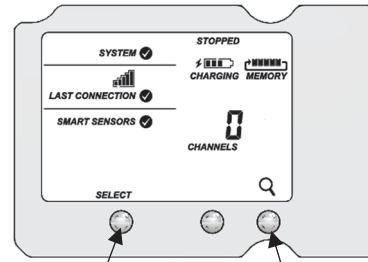

Press the Select button to view the smart sensor screen      Press the Search button for the station to find all connected smart sensors

Note that some smart sensors have more than one channel associated with them so the number of channels may not match the physical number of smart sensors connected (for example the temperature/RH smart sensor has two channels: one for temperature and one for RH).

**7. Add any wireless sensor motes.**

**Important:** Keep the mote(s) near the RX3000 station while completing these steps.

- a. Press select to switch to the module where the RXW Manager is installed (Module 1 or Module 2) and then press the Search button to wait for motes to join the network.

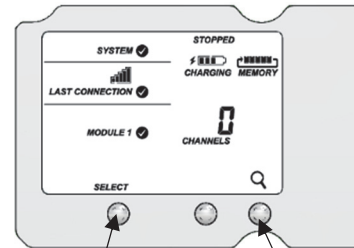

Press the Select button to switch to the module with RXW Manager installed      Press the Search button for the station to search for motes to join

- b. Install the rechargeable batteries in the mote and press the button on the mote for 3 seconds.

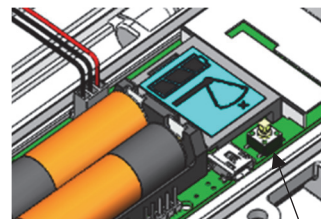

Press this button for 3 seconds

- c. Watch the mote LCD during the process of joining the network.



This signal strength icon blinks while searching for a network.



Once a network is found, the icon will stop flashing and the bars will cycle from left to right.



This network connection "x" icon blinks while the mote completes the registration process, which may take up to five minutes.



Once the mote has finished joining the network, the "x" icon is removed and the channel count on the station LCD increases by the number of measurement channels for the mote plus the battery.

**Note:** If the mote cannot find the network or has trouble remaining connected during this process, make sure the mote is in a vertical, upright position and within range of the station.

Repeat these steps to add other motes. Press the Search button on the station when finished adding motes.

### 8. Connect analog sensors, relay devices, or water level sensors.

**Note:** You may wait to connect these until you are at the deployment site.

Power down the station (unplug any charging device and then disconnect the battery). Connect any sensors or devices to the optional modules as described in the following sections. Be sure to feed any cables or wires through the smaller cable access opening shown below.

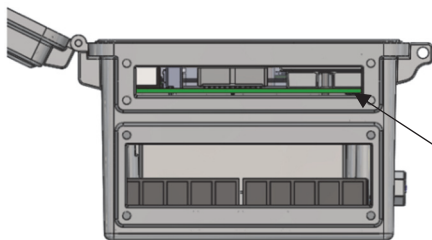

Feed analog sensor, relay, and water level sensor cables through this opening to connect them to the optional modules

**Important:** If you will be installing the weatherproof rubber cable channel in the cable access opening as described in *Deploying and Mounting the Station*, the cable diameter for analog sensors or relay devices must be 4.0 mm (0.156 in.) to fit through one of the smaller holes or 6.4 mm (0.25 in.) to fit through one of the larger holes. If the cable diameter is too small, build up the diameter using heat shrink. If the cable is too big, splice on another cable with a smaller diameter to fit through the hole. If you are using the rubber cable channel designed for the water level sensor, reserve the medium holes for the water level sensor cable.

### To connect analog sensors:

You can connect a two- or three-wire sensor or transducer to one of the four terminals in the analog module.

- Loosen the screw for each pin on the screw terminal.
- Feed the wire through the smaller of the two cable access openings.
- Insert the appropriate wire into the screw terminal (see the pinout table below). The wire should be trimmed to expose 0.25 inches  $\pm$ 0.04 inches of bare wire.
- Tighten the screw.
- Plug in the battery and then the charging device to power up the station.

### Analog Module Pinout Table

J1 Pin #	Pin Description	J2 Pin #	Pin Description
1	CH1 SIGNAL	1	CH3 SIGNAL
2	CH1 GND	2	CH3 GND
3	+12V Excitation	3	+12V Excitation
4	GND (EX. RTN)	4	GND (EX. RTN)
5	CH2 SIGNAL	5	CH4 SIGNAL
6	CH2 GND	6	CH4 GND
7	SHIELD	7	SHIELD

**Note:** All four input channels share the same common ground.

### Analog Module Functional Diagram

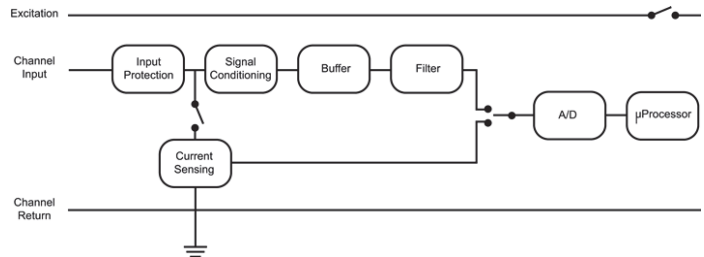

### To connect relay devices:

You can connect up to three devices to the relay module. The relays are only for low power switching. To switch to higher power, use an appropriately rated relay and use the station relay to switch the external relay on or off.

- Loosen the screw for each pin on the screw terminal.
- Feed the wire through the smaller of the two cable access openings.
- Insert the appropriate wire into the screw terminal (pins 1 and 2 are interchangeable, pin 3 is optional; see the pinout table).
- Tighten the screw.
- Plug in the battery and then the charging device to power up the station.

### Relay Module Pinout Table

RELAY-1	Pin Desc.	RELAY-2	Pin Desc.	RELAY-3	Pin Desc.
1	Relay	1	Relay	1	Relay
2	Relay	2	Relay	2	Relay
3	Shield	3	Shield	3	Shield

**To install a water level sensor:**

- a. Feed the water level sensor cable through the smaller of the two cable access openings.
- b. Insert the connector at the end of the cable into the receptacle on the module as shown below. The connector will snap into place once installed. Be careful not to push, pull, or twist the cable while installing the connector.

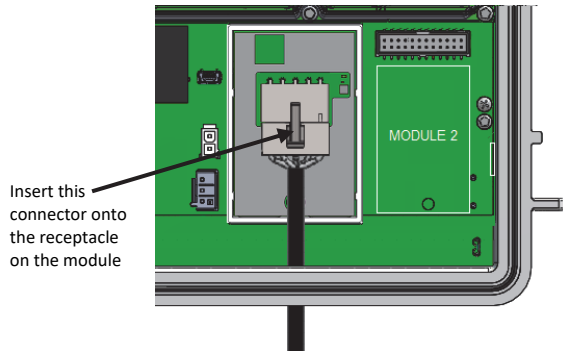

- c. Install any other sensors and cables that will be using the top cable access opening.
- d. Install the top rubber cable channel into the cable access opening.
  - i. Use silicone grease to lightly coat all four outer edges and the inside of the rubber cable channel shipped with the water level sensor module (do not use the small rubber cable channel shipped with the RX3000 station).
  - ii. Use the grease to lightly coat the portion of the water level sensor cable that will be in the cable channel. Repeat for all other cables.
  - iii. Position the cable channel around the cables, routing the cables through the proper grooves. Use one of the medium-sized holes shown below for the water level sensor cable.

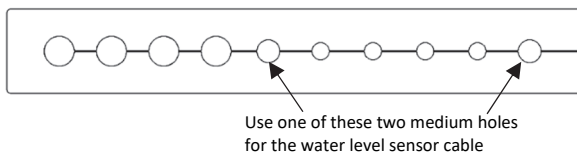

- iv. Close the cable channel and press it into the opening.
- v. Install the cover plate with loosely installed thumbscrews.
- vi. Lightly coat rubber plugs with a small amount of grease and use them to fill the empty holes. Use one of the rubber plugs included with the water level sensor module to fill the empty medium hole. Use the rubber plugs from the channel kit included with the station to fill any remaining large and small holes. Insert the thin part of the plug into the hole and push it in until the thick part fills the hole.
- vii. Tighten the thumbscrews on the cover plate.
- viii. Repeat these steps with the large cable channel. See *Installing the Weatherproof Rubber Cable Channel and Covers* for additional details.

- e. Insert the water level sensor cable jack into the water level sensor. Screw on the locking nut (hand tight).

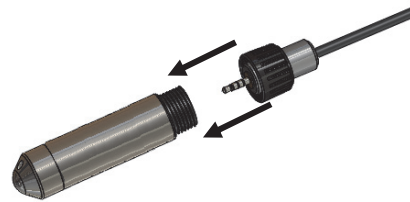

**Important:** Make sure the O-rings on the cable jack end and the sensor mating housing surfaces are clear of any debris. Any contamination of these surfaces can cause leaks that may lead to sensor failure.

- f. Plug in the battery and then the charging device to power up the station.

**9. Connect to HOBOLink.**

Use the Select button to return to the main LCD screen that shows all sensors and modules and then press the Connect button (the cloud icon should be visible as shown in the following example). This is necessary for HOBOLink to identify the newly added sensors (it does not start logging; this will be done later in this procedure). Note that analog sensors will not be listed in the channels count on the LCD until they are configured in HOBOLink in the next step.

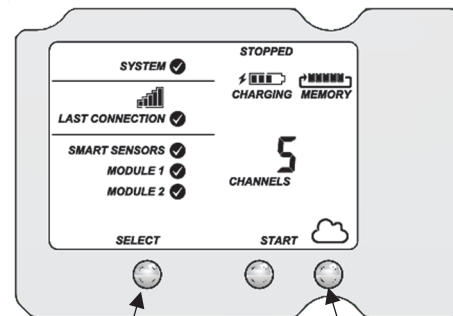

Press the Select button to return to the main LCD screen      Press the Connect button

**10. Configure the station in HOBOLink.**

Select Devices, RX Devices, and then click the  icon next to your station. Use the configuration screens in HOBOLink to finish setting up the station, starting with General Configuration (the nickname, time zone, and image for the station). Use the Next button to move from one configuration screen to the next or use the left menu to select a specific item to configure. Follow the steps in the next subsections to configure the readout settings, smart sensors, wireless sensors, and optional modules. Any changes you make will take effect the next time the station connects to HOBOLink. **Note:** Click Save or Next in any screen to save your changes. You will lose any changes made if you click Back without clicking Next or Save first.

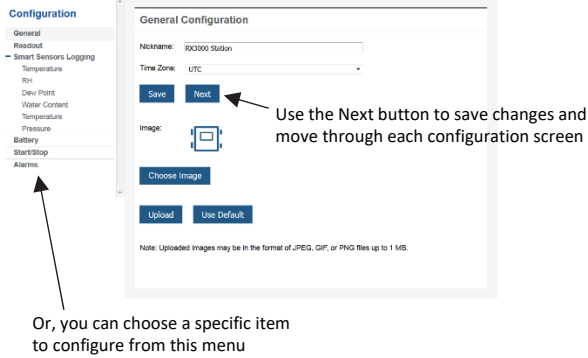

**Tip:** When a sampling interval is configured, the station will take multiple measurements within a given logging interval and then average them together to create a single logged data point. This is only an option for the following smart sensors that support measurement averaging: temperature (S-TMB-M0xx), PAR (S-LIA-M003), solar radiation (S-LIB-M003), barometric pressure (S-BPA-CM10 and S-BPB-CM50), 4-20mA input (S-CIA-CM14), 12-bit voltage input (S-VIA-CM14), and FlexSmart TRMS module (S-FS-TRMSA-D). Disable the sampling interval if none of your smart sensors support measurement averaging to avoid unnecessary drain on the battery power.

**Readout Configuration**

- a. Set the connection interval, which is how often the station will connect to HOBOLink. For the RX3003 and R3004 cellular models, the minimum connection interval depends on your communication plan.
- b. If you wish to set up a second connection interval, select the “Night mode” checkbox. Select when night mode should begin and end and then enter the connection interval you want to use during that part of the day. (The night mode schedule can take effect any time during the day; it does not have to be at night.) Use this option to save data in your communications plan (if applicable) or to conserve battery power at night when solar charging is unavailable. You can view current plan usage in the Device Information section on your station’s page in HOBOLink.
- c. Click Save or click Next.

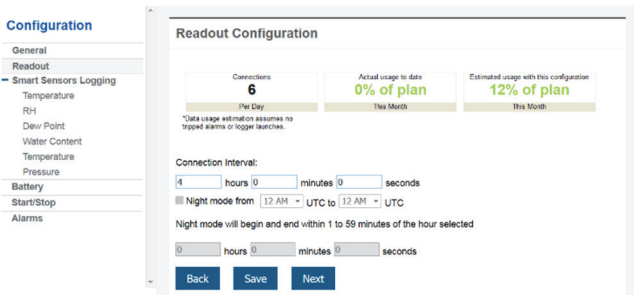

- d. Click Save or click Next.

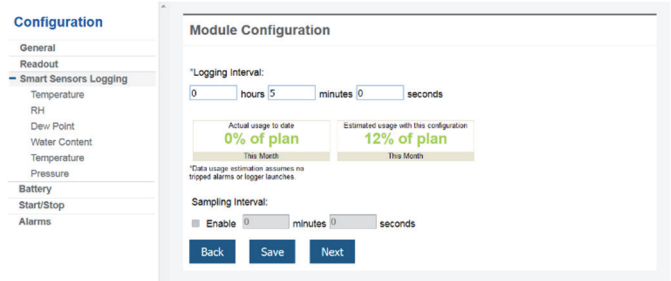

- e. Click a smart sensor from the menu.
- f. Type a label for the smart sensor (optional) and click to enable or disable the graph (enabled by default).
- g. To set up scaling for the smart sensor, click the Enable Scaling checkbox and fill in the Scaled Units, Multiplier, Offset, and Scaled Measurement Type fields.
- h. Click Save. You can also click Next to move from one smart sensor to the next.

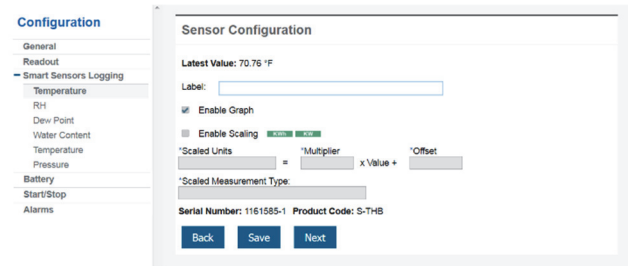

- i. Repeat steps e–h for any additional smart sensors you need to configure.

**Smart Sensors Logging and Configuration**

You can configure both the global settings that affect all smart sensors (logging interval and sampling interval) and the settings for each smart sensor (labels, graphs, and scaling).

- a. Click Smart Sensors Logging from the menu on the left.
- b. Select the logging interval. This will be used by all configured smart sensors.
- c. Enable the sampling interval and enter the rate to use in minutes and seconds.

**Water Level Sensor Module Configuration**

You can configure both the global settings that affect all water level sensor channels (logging interval and sampling interval) and the settings for each individual channel. The water level sensor includes the following four channels that automatically record data at each logging interval: barometric pressure, water pressure, differential pressure, and water temperature. You can also configure water level and water flow channels that calculate data based on the logged data from the four sensor channels and the values you enter in HOBOLink.

- a. Click Water Level Sensors Logging from the Configuration menu.
- b. Select the logging interval. This will be used by all channels associated with this sensor.

- c. Enable the sampling interval (if desired) and enter the rate to use in minutes and seconds.
- d. Click Save or Next.

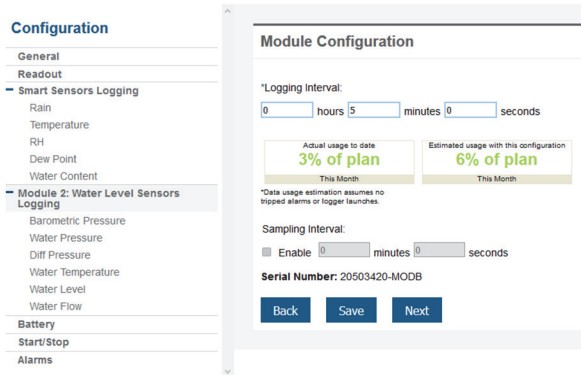

**To add labels or scaling:**

- a. Click Barometric Pressure from the Configuration menu.
- b. Type a label for the channel (optional) and click to enable or disable the graph (enabled by default).
- c. To set up scaling for the channel, click the Enable Scaling checkbox and fill in the Scaled Units, Multiplier, Offset, and Scaled Measurement Type fields.
- d. Click Save. Repeat steps a–d for Water Pressure, Diff Pressure, and Water Temperature.

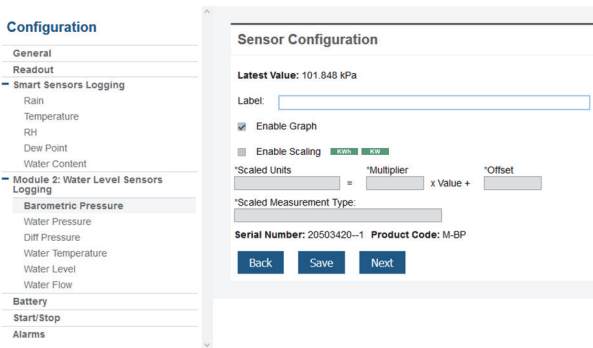

**Important:** Do not configure the water level and water flow channels yet. Configure any other sensors or relays as necessary, continue to step 11 to start logging, and then obtain a water reference level reading in step 12.

**Wireless Sensor Configuration**

You can configure both the global settings for the RXW Manager module that affect all sensor motes (logging interval) and the settings for each individual mote (labels, enabled graphs, and scaling).

- a. Click Module <#>: Wireless Sensors Logging from the menu on the left.

- b. Select the logging interval to be used for all wireless sensors, which can be different than the one used for smart sensors and analog sensors (if applicable).

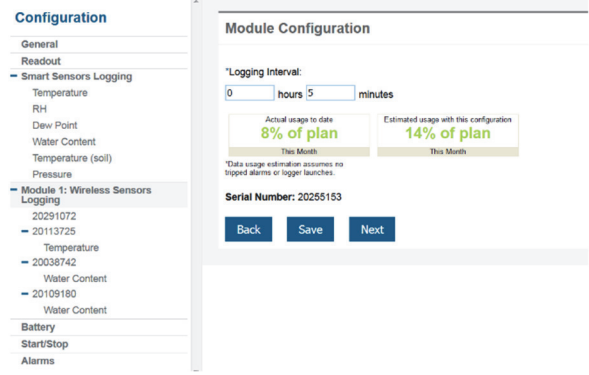

- c. Click Save or Next.
- d. Click one of the motes from the menu under Module <#>: Wireless Sensors Logging as shown in the following example. Click the serial number or name for the mote, not the measurement type.

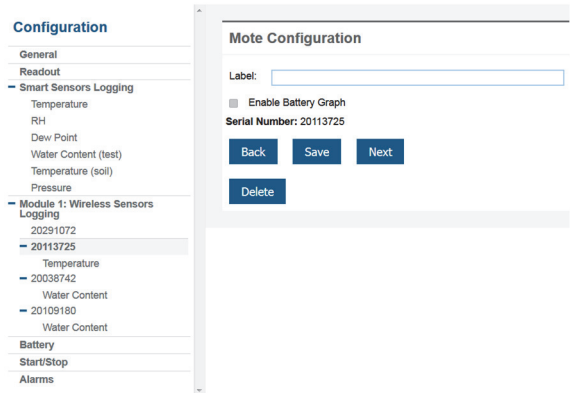

- e. Type a label for the mote (optional) and click to enable the battery graph for the mote if desired. The label will also automatically be applied to any mote sensors without a default label.
- f. Click Save or click to Next to move to either the next mote (if it was a repeater) or the sensor measurement type for that mote.
- g. Click one of the mote measurement types from menu under Module <#>: Wireless Sensors Logging as shown in the following example

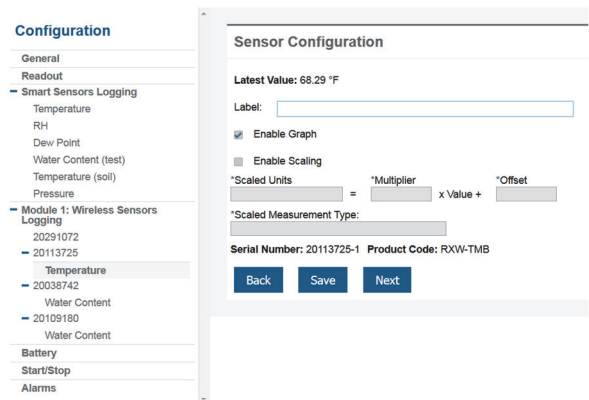

- h. Type a label for the measurement type (optional) and click to enable or disable the graph (enabled by default).

- i. To set up scaling for the wireless sensor, click the Enable Scaling checkbox and fill in the Scaled Units, Multiplier, Offset, and Scaled Measurement Type.
- j. Click Save or click Next.
- k. Repeat steps d–j for any additional notes you need to configure for the module.

**Analog Module and Sensor Configuration**

You can configure both the global settings for the analog module that affect all connected analog sensors (logging interval, statistics, and excitation) and the settings for each individual analog sensor (enabled logging and graphs, labels, sensor type, and scaling).

- a. Click Module <#>: Analog Sensors Logging from the menu on the left.
- b. Select the logging interval to be used for all analog sensors, which can be different than the one used for smart sensors and wireless sensors (if applicable).

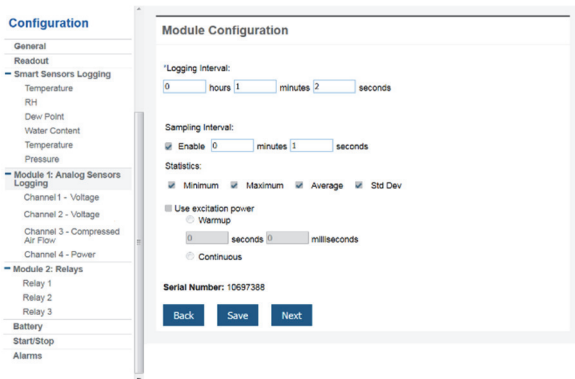

- c. Click the Enable checkbox under Sampling Interval if you want to log statistics. Enter the sampling interval to be used for calculating the statistics (must be a factor of the logging interval). Select the statistics to be logged: minimum, maximum, average, and standard deviation. The selected statistics will be calculated between each logging interval at the sampling interval rate you select. Each statistical value will then be logged at each logging interval.
- d. Enable “Use excitation power” if you want sensors to use the 12 V DC excitation voltage provided by the station. Select warmup and enter the seconds or milliseconds (5 milliseconds to 120 seconds), or select continuous. Note that the excitation power selected will be used for all of the module’s configured sensors.

- With warmup, the station supplies excitation power, 12 V DC, for a brief period prior to each measurement. This allows you to select the minimum warm-up time needed to allow for sensor stabilization while conserving battery power. For example, if you specify a warm-up of one second and set the logging interval for the module to one minute, the station will power the external sensor for one second, log a measurement, and then turn off the excitation power for the next 59 seconds. Note that the excitation mode is automatically set to Continuous if the warmup time selected is within one second of or greater than the logging or sampling intervals.

- With continuous, the station supplies constant excitation power to the sensor for the entire duration of the deployment. Continuous mode is required if the sensor needs more than two minutes of warm-up time.

**Important:** Continuous mode operation will greatly affect battery operating life and is not recommended.

Note that excitation power will not be enabled until logging begins (if “Logging” is blinking on the LCD, then excitation is not being used).

- e. Click Save. You can also click Next to move from one analog channel to the next.
- f. Click one of the four analog sensor channels from the menu, such as Channel 1 shown in this example.

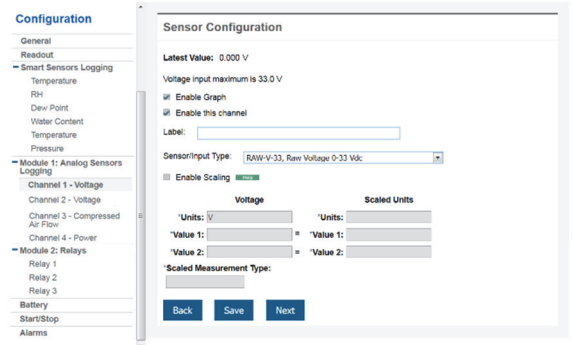

- g. Select “Enable Graph” if you want the sensor data to be graphed in HOBOLink.
- h. Select “Enable this channel” if you want the station to record data for this channel. If the channel is not enabled, then it will not be part of the channel count shown on the LCD.
- i. Type a label for the sensor (optional).
- j. Select the sensor/input type, which is needed to set the voltage or current range for the analog input.
- k. Click the Enable Scaling checkbox and then enter the raw and scaled unit values as defined in the sensor manual. Type the scaled measurement type.
- l. Click Save. You can also click Next to move from one channel to the next.
- m. Repeat steps f–l for any additional analog sensors you need to configure for the module.

**Relay Module Configuration**

- a. Click one of the three relays from the menu on the left, such as Relay 1 in the following example.

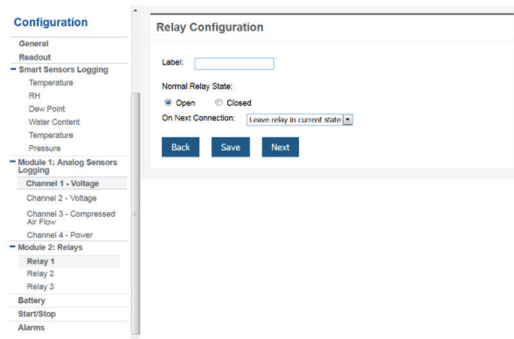

- b. Type a label and select Open or Closed for the Normal Relay State. The label can be used to show what Open



or Closed corresponds to in your system (for example, “closed relay turns pump on”).

- c. Select what should happen on the next connection with the station: open relay, close relay, or leave it at its current state.
- d. Click Save or click Next.
- e. Repeat steps a–d for any additional relays you wish to configure.

**Tip:** Refer to *Setting System and Sensor Alarms* for details on using sensor alarms to activate the relays.

### 11. Start logging.

After you have finished configuring all the settings in HOBOLink, you can start logging when ready. Press the Start button on the station to start logging. The station will connect to HOBOLink (“Connection” will blink on the LCD) and then logging will begin at the logging interval specified for smart sensors and analog sensors (if applicable).

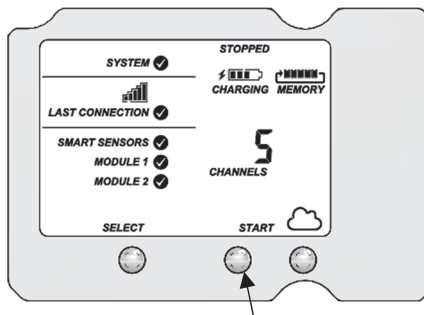

Press this button to start logging

You can also start logging from HOBOLink. Select Start/Stop from the Configure menu in HOBOLink and click Start. Logging will not begin until the next time the station connects to HOBOLink. Press the Connect button on the station to connect to HOBOLink at any time.

Once logging begins, “Logging” appears in the upper right corner of the LCD as shown in the following example. “Logging” will blink until the first logging sample is recorded. At that point, it will stop blinking and remain illuminated until logging is stopped. Also note that the channels count on the LCD screen will be updated to include any analog sensors that were enabled in HOBOLink.

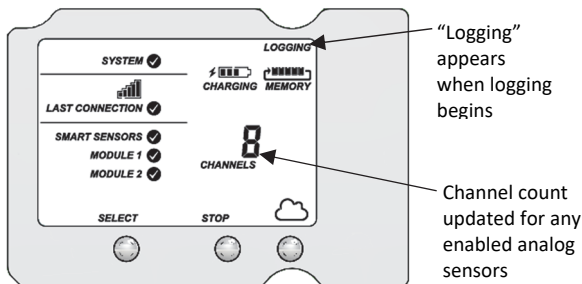

“Logging” appears when logging begins

Channel count updated for any enabled analog sensors

**Important:** See *Deploying and Mounting the Station* for installation steps and other deployment guidelines. If using the station outdoors or in harsh indoor conditions, you must install the sensor cable channels and the plates for weatherproofing. This must be completed before continuing to step 12 if you are using a water level sensor.

### 12. If you installed a water level sensor module and sensor, obtain a reference water level reading.

Make sure the water level sensor is deployed in its final location and the station is logging. Take a reference level reading, measuring the water level from your reference point.

**Important:** Note the reference level reading as well as the date and time it was taken.

### 13. If you installed a water level sensor module and sensor, configure the water level and water flow channels in HOBOLink.

Perform the following steps in the field in HOBOLink with a mobile device to verify that the system is logging the water level correctly while you are still at the station site.

#### Water Level Configuration

- a. In HOBOLink, select Devices and then RX Devices and click the  icon next to your station.
- b. Under the water level sensors module in the Configuration menu, select Water Level.

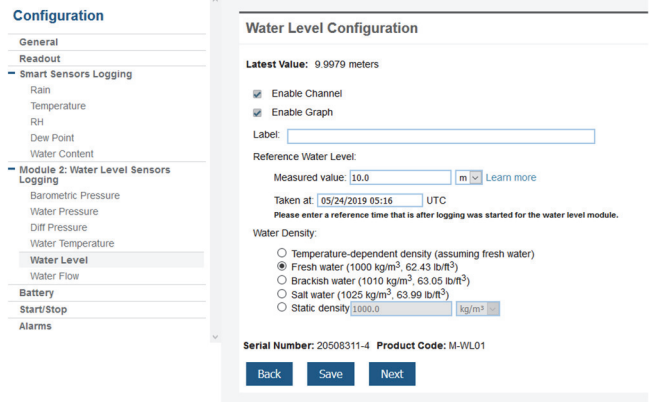

- c. Click the checkbox to Enable Channel.
- d. Click the checkbox to Enable Graph and type a label (optional).
- e. Enter the reference water level and date and time noted in step 12.
  - If the water level surface is **below** the reference point, enter the reference water level as a negative number.
  - If the water level surface is **above** the reference point, enter the reference water level as a positive number.
- f. See *Setting Up Water Level and Water Flow Channels in HOBOLink* for example diagrams showing reference points.
- f. Select the appropriate water density.
- g. Click Save.

## Water Flow Configuration

- Select Water Flow from the Configuration menu.

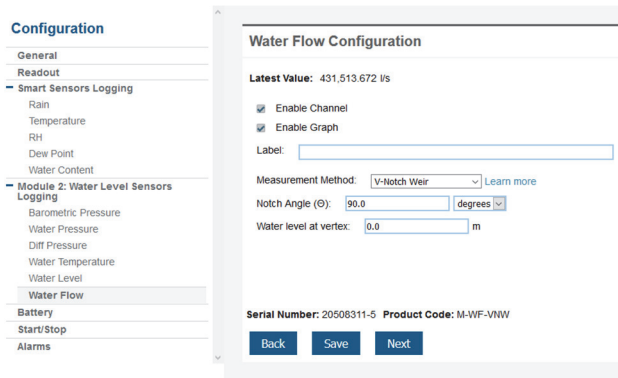

- Click the checkbox to Enable Channel.
- Click the checkbox to Enable Graph and type a label (optional).
- Choose the measurement method for water flow.
- Enter the appropriate information for the method selected. See *Setting Up Water Level and Water Flow Channels in HOBOLink* for more details on water flow measurement methods.
- Click Save.

Water level and flow data will be calculated starting with the next connection to HOBOLink. If you don't want to wait for the next scheduled connection, press the Cloud button on the station LCD to connect to HOBOLink immediately. Note that the reference water level information entered in this step will not affect data already stored in HOBOLink.

## Viewing Data in HOBOLink

Data is uploaded to HOBOLink each time the device connects. For a snapshot of the latest conditions, click Devices, then RX Devices, and click the device name to view the readings from the last connection for smart sensors and logged analog sensors. You can also view any enabled graphs as shown in the following example.



Logged data is saved in a database. You can export this data on demand as needed or set up automatic exports that are delivered to email and/or FTP addresses on a schedule you specify.

To download and export data:

- In HOBOLink, click Data and Exports.
- Click Create New Export.
- Follow the instructions on the screen to select the name, format, time zone, and time frame, and then the devices

and sensors to include in the export. Reorder the sensors as needed.

- Click Save to keep these settings for future use or click Export Data to export immediately.

To set up a scheduled data delivery:

- Click Data and then click Data Delivery).
- Click Create New Delivery.
- Under General Settings, type the name of the delivery schedule and the frequency of delivery. Enable the Active checkbox. Select other settings if desired.
- Under Select Data to Export, choose the name of the custom data export you want to be delivered (or follow the previous set of steps to set up a custom data export).
- Under Data Destination, select FTP/SFTP or Email for the delivery method and fill in the appropriate fields.
- Click Save. Data will then be delivered on the schedule you selected.

For more information on Data Delivery, see the HOBOLink Help.

See also HOBOLink Help for other ways to monitor your station, including setting up a map or using dashboards.

## Setting System and Sensor Alarms

You can set up both system and sensor alarms in HOBOLink. System alarms can trip when there is a missed connection, the battery is low, or if there is a smart sensor failure. With a sensor alarm, you can configure an alarm to trip at one level and clear at another.

### System Alarms

To add a system alarm:

- In HOBOLink, click Devices, then RX Devices, and find the station you want to configure. Click the arrow next to  and select Alarm Configuration.
- Click Edit System Alarms.
- For Missed Connection alarms:
  - Under Communication, select the Missed Connection checkbox.
  - Set the length of time for HOBOLink to wait after the station has missed a connection before an alarm trips.
  - Select the action to be taken when this alarm trips: send an email or text. Enter the details and then select "Send on Clear Also" if you want an email or text when the alarm clears as well.

**Important:** Standard data fees and text messaging rates may apply when using text notifications. Onset does not charge a fee or guarantee delivery of text alerts, which is subject to your carrier's service and location. See the HOBOLink Help for additional details on alarm notifications.

- Click Add Action if you want multiple actions to be taken when the alarm trips (for example send an email and a text).
- For Battery Low and Sensor Failure alarms:
    - Under Device, select the Battery Low and/or Sensor Failure checkboxes.

- b. Select how you want to be notified when these alarms trip: by email or text. Enter the appropriate addresses and then select “Send on Clear Also” if you want an email or text when these alarms clear as well.
5. Click Add Action if you want multiple actions to be taken when the alarm trips (for example send an email and a text).
6. Click Save. Changes will take effect the next time the station connects to HOBOLink.

Red alarm symbols will appear in HOBOLink when these alarms trip (if enabled).

**Note for wireless sensors:** If a wireless sensor mote goes offline from the network for 30 minutes, the station will automatically connect to HOBOLink to report the missing mote regardless of any alarm settings in place. Unless the mote has no battery power, it will continue logging data even if it is offline from the network. Once the mote is back online, any logged data will be uploaded during regular connections to HOBOLink. **Note:** Once a mote is back online, it enters recovery mode as HOBOLink receives the data logged while it was offline. During this period of recovery, data for that mote will temporarily be unavailable for data delivery, dashboards, and data feeds. See the HOBOLink help for additional details.

### Sensor Alarms

To add a sensor alarm:

1. In HOBOLink, click Devices, then RX Devices, and find the station you want to configure. Click the arrow next to  and select Alarm Configuration.
  2. Click Add a Sensor Alarm.
  3. Select the sensor.
  4. Select whether the alarm should trip above or below a value or within a range.
  5. Enter the sensor reading(s) for the alarm threshold.
  6. Enter the number of logged data points you want the station to record before the alarm trips.
  7. If you selected the alarm to trip above or below a specific reading, then select when the alarm should clear: above or below the same value or a different value. Enter the value if necessary.
  8. Select the action to be taken when the alarm trips: send an email or text or close, open, or pulse one of the three relays if a relay module is installed. For email or text, enter the details and then select “Send on Clear Also” if you want an email or text when the alarm clears as well.
- Important:** Standard data fees and text messaging rates may apply when using text notifications. Onset does not charge a fee or guarantee delivery of text alerts, which is subject to your carrier’s service and location. See the HOBOLink Help for additional details on alarm notifications.
9. Click Add Action if you want multiple actions to be taken when the alarm trips (for example, close the relay and send an email).
  10. Add any optional notes for this alarm.
  11. Click Save. Changes will take effect the next time the station connects to HOBOLink.

12. Repeat steps 2 through 11 for each additional sensor alarm you want to add.

A red alarm symbol appears next to that sensor in HOBOLink when it trips. An alarm symbol will also appear on the LCD.

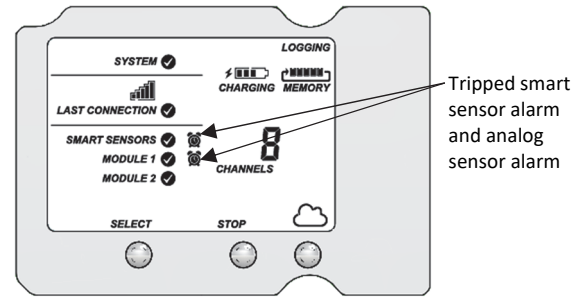

### Setting up Water Level and Water Flow Channels in HOBOLink

If both a water level sensor module (RXMOD-W1) and water level sensor are installed, the station will automatically log four measurement channels:

- Barometric pressure
- Water pressure
- Differential pressure
- Water temperature

In addition, you can set up two additional channels in HOBOLink:

- Water level
- Water flow

These derived channels are only available once enabled in HOBOLink. The data for these two channels are calculated at each logging interval based on the measurements from the pressure and temperature channels and the settings and values you enter in HOBOLink.

If a water level sensor is not physically connected to the module, barometric pressure will be the only channel logged related to the water level sensor. You will not be able to set up water level and water flow unless you install the water level sensor as described in *Setting up the Station*. Similarly, if you unplug a water level sensor while a station is logging, only barometric pressure will be logged and the rest of the water level sensor channels will report errors.

### Setting up a Water Level Channel

**Important:** Make sure the station has started logging and you have taken a reference water level reading from the location where the sensor is deployed with the date and time of the reading before performing these steps.

To set up a water level channel:

1. In HOBOLink, select Devices and then RX Devices and click the  icon next to your station.
2. Under the water level module in the Configuration menu, select Water Level.
3. Click the checkbox to Enable Channel.
4. Click the checkbox to Enable Graph and type a label (optional).
5. Enter the reference water level and date and time the reading was taken.

- If the water level surface is **below** the reference point as shown below, enter the reference water level as a negative number.

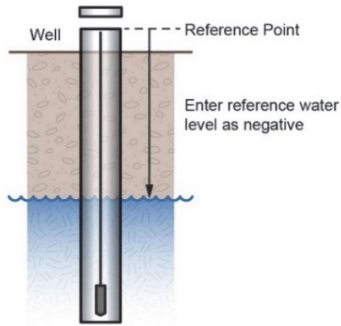

- If the water level surface is **above** the reference point as shown below, enter the reference water level as a positive number.

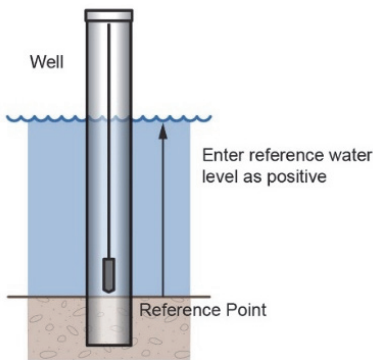

6. Select the appropriate water density for your deployment location.
7. Click Save.

Water level will be calculated starting with the next connection to HOBOLink. Note that the reference water level information entered in this step will not affect any previously logged data. It will only be use for data logged from the point of the next connection to HOBOLink forward. If this is the first time that water level has been configured for this station, then the data stored will go back to the date and time of the reference water level. If you make other updates to the reference water level, then the data will only be updated from the time of the next connection to HOBOLink.

### Setting up a Water Flow Channel for a V-Notch Weir

If you are using a v-notch weir similar to the upper diagram below along with the water level sensor, then HOBOLink can calculate the flow rate for each water level reading using the following two values that you enter:

- The notch (vertex) angle in degrees or radians, which is represented as  $\theta$  in the second diagram.
- The distance from the reference point to the v-notch vertex, which is represented as WLv in the second diagram. This value must be entered in the same units as the reference water level you entered for the water level channel (meters or feet).

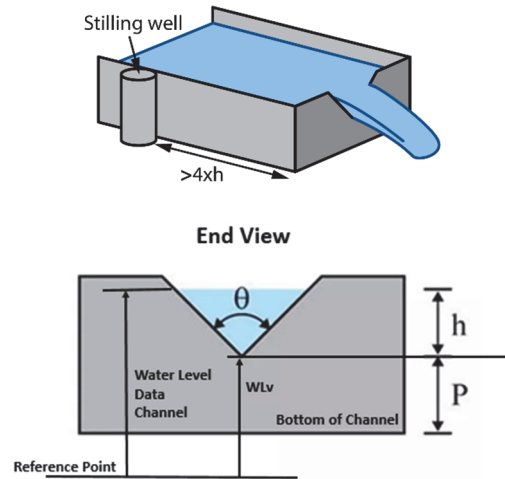

The HOBOLink water flow calculations for a v-notch weir assume the following:

- The stilling well with the water level sensor should be placed at a distance of at least  $4 \times h_{max}$  upstream of the weir.
- In general, if the notch area is small relative to the area of the approach channel, the weir is “fully contracted” and these flow equations will work. More specifically, the ratio of the channel width to the v-notch width should be greater than 3, and the ratio of  $h_{max}/p$  should be less than 1. It may also work for weirs not meeting these guidelines if the approach channel is smooth, straight, and rectangular.
- The weir should be between 0.8 and 2 mm (0.03 and 0.08 inches) thick in the v-notch. If the bulk of the weir is thicker than 2 mm (0.08 inches), the downstream edge of the v-notch can be chamfered at an angle greater than 45° (60° is recommended) to achieve the desired thickness of the edges. Avoid water clinging to the downstream face of the weir.
- The head height (h) must be no more than 35% of the distance from the channel bottom to v-notch-vertex (P).
- The head height must be at least 6 cm (2.36 inches). When the head height is less than 6 cm (2.36 inches), the flow calculation will not be as accurate.
- The average width of the approach channel should be greater than 91 cm (3 ft).
- The bottom of the v-notch should be at least 45 cm (1.5 ft) above the bottom of the upstream channel.

**Important:** Make sure the station has started logging and you have configured the water level channel with a reference level reading before performing these steps.

To set up a water flow channel using a v-notch weir:

1. Click Devices and then RX Devices, and find the station you want to configure. Click the arrow next to the icon and select Module/Sensor Configuration.
2. Under the water level module in the Configuration menu, select Water Flow.
3. Click the checkbox to Enable Channel.
4. Click the checkbox to Enable Graph and type a label (optional).

5. For the Measurement Method, select V-Notch Weir.
6. Enter the notch (vertex) angle of the weir in degrees or radians.
7. For the "Water level at vertex," enter the distance from the reference point to the v-notch vertex in either meters or feet (using the same reference point and units you used for the reference water level in the water level channel).
  - If the vertex is the reference point, then enter 0.
  - If the reference point is the bottom of the channel, then the value is represented as P in the diagram earlier in this section.
  - If the reference point is above the water level (such as when using ground level as the reference point in a storm sewer), then enter a negative number.
  - If the reference point is below the water level, then enter a positive number.
8. Click Save.

Water flow will be calculated starting with the next connection to HOBOLink.

**Tip:** It is good practice to set an alarm for the water level just below the top of the v-notch so you know when the flow data is close to exceeding its valid range. See *Setting System and Sensor Alarms*.

### Setting up a Water Flow Channel for a Rectangular Weir

If you are using a rectangular thin-plate weir similar to the diagram below on the left along with the water level sensor, then HOBOLink can calculate the flow rate for each water level reading using four values that you enter. Note that these values must be entered in the same units as the reference water level you entered for the water level channel (meters or feet). The values are:

- The notch width, which is represented as  $b$  in the second diagram.
- The channel width, which is represented as  $B$  in the second diagram.
- The notch height above the channel floor, which is represented as  $P$  in the second diagram.
- The distance from the water level reference point to the notch crest, which is represented as  $WLC$  in the second diagram.

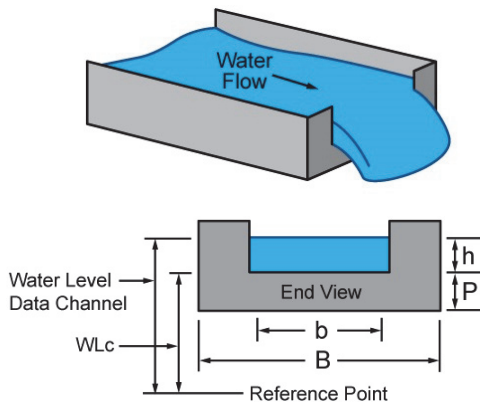

The HOBOLink water flow calculations for a rectangular weir assume the following:

- The range for the weir opening width is 0.15 to 6 m (0.5 to 20 ft).

- The notch height ( $P$ ) must be at least 0.1 m (0.33 ft).
- Either  $B = b$  (full-width weir) or  $B - b$  must be at least 0.2 m (0.66 ft) (contracted weir).
- The weir should be between 1 to 2 mm (0.03 to 0.08 inches) thick in the opening. If the bulk of the weir is thicker than 2 mm (0.08 inches), the downstream edge of the opening can be chamfered at an angle greater than 45° (60° is recommended) to achieve the desired thickness of the edges, and avoid water clinging to the downstream face of the weir.
- The range for the head height ( $h$ ) is 0.03 to 1.4 m (0.18 to 4.5 ft).
- The range for the flow rate is from 3.45 to 17,188 l/s (0.122 to 607 ft<sup>3</sup>/s).
- The value of  $h/p$  cannot be greater than 2.5.
- Water surface downstream of the weir should be at least 0.06 cm (2.36 inches) below the weir crest (i.e. below the bottom of the opening).

**Important:** Make sure the station has started logging and you have configured the water level channel with a reference level reading before performing these steps.

To set up a water flow channel using a rectangular weir:

1. Click Devices and then RX Devices, and find the station you want to configure. Click the arrow next to the  icon and select Module/Sensor Configuration.
2. Under Module 2: Water Level Sensors Logging on the left menu, select Water Flow.
3. Click the checkbox to Enable Channel.
4. Click the checkbox to Enable Graph and type a label (optional).
5. For the Measurement Method, select Rectangular Weir.
6. Enter the notch width in either meters or feet. **Note:** Use the same units for this and all rectangular weir values as you entered for the reference water level in the water level channel.
7. Enter the channel width in either meters or feet.
8. Enter the notch height above the channel floor in either meters or feet.
9. For the Distance from Water Level Ref Point to Notch, enter the distance from the reference point to the notch crest in either meters or feet.
  - If the notch crest is the reference point, then enter 0.
  - If the reference point is the bottom of the channel, then the value is represented as  $P$  in the diagram earlier in this section.
  - If the reference point is above the water level (such as when using ground level as the reference point in a storm sewer), then enter a negative number.
  - If the reference point is below the water level, then enter a positive number.
10. Click Save.

Water flow will be calculated starting with the next connection to HOBOLink.

## Setting up a Water Flow Channel for a Trapezoidal Weir

If you are using a trapezoidal or Cipoletti thin-plate weir similar to the one in the diagram below on the left along with the water level sensor, HOBOLink can calculate the flow rate for each water level reading using two values that you enter. Note that these values must be entered in the same units as the reference water level you entered for the water level channel (meters or feet). The values are:

- The width at the base of the notch, which is represented as  $b$  in the second diagram.
- The distance from the water level reference point to the notch crest, which is represented as  $WLC$  in the second diagram.

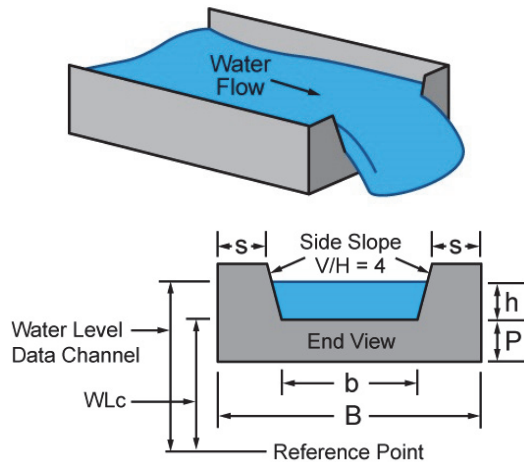

The HOBOLink water flow calculations for a trapezoidal weir assume the following:

- The slopes of the notch sides must be 4 (vertical change / horizontal change).
- Head height ( $h$ ) should be measured at a distance of at least  $4 \times h_{max}$  upstream of the weir.
- The weir should be between 1 to 2 mm (0.04 to 0.08 inches) thick in the opening. If the bulk of the weir is thicker than 2 mm (0.08 inches), the downstream edge of the opening can be chamfered at an angle greater than  $45^\circ$  ( $60^\circ$  is recommended) to achieve the desired thickness of the edges and avoid water clinging to the downstream face of the weir.
- Water surface downstream of the weir should be at least 0.06 m (0.2 ft) below the weir crest (i.e. below the bottom of the opening).
- The head height ( $h$ ) must be at least 0.06 m (0.2 ft), but less than  $b/3$ .
- The crest height above the channel floor ( $P$ ) is measured from the bottom of the upstream channel and should be greater than  $2 \times h_{max}$ .
- " $S$ " is measured from the sides of the channel and should be greater than  $2 \times h_{max}$ .

**Important:** Make sure the station has started logging and you have configured the water level channel with a reference level reading before performing these steps.

To set up a water flow channel using a trapezoidal weir:

1. Click Devices and then RX Devices, and find the station you want to configure. Click the arrow next to the  icon and select Module/Sensor Configuration.
2. Under Module 2: Water Level Sensors Logging on the left menu, select Water Flow.
3. Click the checkbox to Enable Channel.
4. Click the checkbox to Enable Graph and type a label (optional).
5. For the Measurement Method, select Trapezoidal Weir.
6. Enter the notch width at the bottom in either meters or feet, using the same units as you entered for the reference water level in the water level channel.
7. For the Distance from Water Level Ref Point to Notch, enter the distance from the reference point to the notch crest in either meters or feet (using the same reference point and units you used for the reference water level).
  - If the notch crest is the reference point, then enter 0.
  - If the reference point is the bottom of the channel, then the value is represented as  $P$  in the diagram earlier in this section.
  - If the reference point is above the water level (such as when using ground level as the reference point in a storm sewer), then enter a negative number.
  - If the reference point is below the water level, then enter a positive number.
8. Click Save.

Water flow will be calculated starting with the next connection to HOBOLink.

## Setting up a Water Flow Channel for a General Flume

If you are using a flume along with the water level sensor, then HOBOLink can calculate the water flow using a general flow equation supported by a wide range of flumes that require only one water level measurement to calculate flow, including ramp, cutthroat, Parshall as well as broad-crested rectangular weirs. The equation that HOBOLink uses is: Water Flow ( $Q$ ) =  $C * (Water\ Level - Head\ Offset)^n$ . Flumes that require two or three water level measurements to calculate flow are not supported.

For this equation to be accurate, there are constraints on the flow conditions and flume design, including:

- Minimum and maximum flow rates
- Minimum and maximum head levels
- Ratio of the width of the weir/flume to the head
- Ratio of the height of the weir/flume to the head
- Location in the flume or weir for measuring the head.

The constraints depend on the type and characteristics of the flume you are using, which can be obtained from the flume manufacturer.

**Important:** Make sure the station has started logging and you have configured the water level channel with a reference level reading before performing these steps.

To set up a water flow channel using a general flume:

1. Click Devices and then RX Devices, and find the station you want to configure. Click the arrow next to the  icon and select Module/Sensor Configuration.

2. Under the water level module in the Configuration menu, select Water Flow.
3. Click the checkbox to Enable Channel.
4. Click the checkbox to Enable Graph and type a label (optional).
5. For the Measurement Method, select General Flume.
6. For the Flume Coefficient, enter the C value listed in your flume's equation table, which can typically be found in the flume manufacturer's documentation. The Flume Coefficient may also be labeled K by some manufacturers so be sure to check how the coefficient is being used in their equation to make sure it is the right one to enter here.
7. For the Head Offset, enter the value in either meters or feet, using the same units as you entered the reference water level in the water level channel. An example of Head Offset is shown in the following diagram of a ramp flume.
  - If you are using a ramp flume as shown in the diagram below and the top of the ramp is the reference point, then enter 0.
  - If you are using a ramp flume and the bottom of the channel leading to the ramp (or crest) is the reference point, then enter the height of the ramp or crest for the Head Offset (represented as P in the diagram).

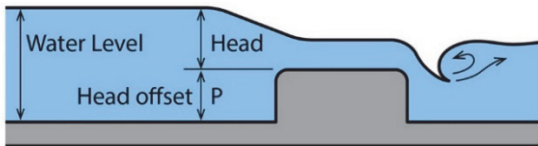

For other types of flumes, such as this example diagram where the water level (or H) is being measured from the bottom of the flume:

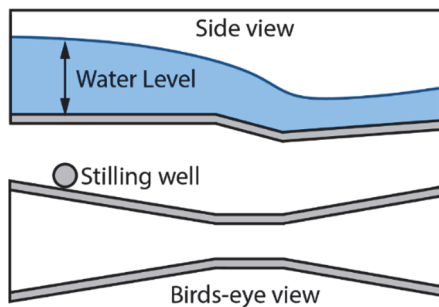

- If the bottom of the flume is the reference point for both the water level and head, then enter 0 for the head offset.
  - If the reference point is above the water level (such as when using ground level as the reference point in a storm sewer), then enter a negative number.
  - If the reference point is below the water level, then enter a positive number.
8. For the Head Exponent, enter the n value listed in your flume's equation table, which can typically be found in the flume manufacturer's documentation.
  9. Click Save.

Water flow will be calculated starting with the next connection to HOBOLink.

## Setting up a Water Flow Channel for a Stage-Discharge Table

You can set up a water flow channel that is calculated based on up to 20 stage-discharge points that you enter. Keep in mind that the units of the stage-discharge table for water flow are assumed to be the same as those entered for the reference water level. If the reference water level was entered in meters, then points in the table must be entered in meters and l/s (liters per second). If the reference water level was entered in feet, then points in the table must be entered in feet and cfs (cubic feet per second).

Before you begin setting up the channel, you will need to determine the values to enter into the stage-discharge table. HOBOLink does not derive a stage discharge curve. Use another method to determine the stage-discharge curve for your site and then enter points from that curve into the HOBOLink stage-discharge table. HOBOLink linearly interpolates between the points that you enter. You can estimate and enter intermediate points as needed to match your stage-discharge curve as best as possible. HOBOLink does not extrapolate beyond the lowest and highest stage values that you enter so make sure to enter values that span the full range of potential stage levels for your site, including flood conditions. Any measured water levels that are outside of the range you enter will be shown as sensor errors (-888.88) for the water flow channel.

Follow these guidelines for getting a stage-discharge rating curve for your site:

- If you are working with a USGS gaging site, you can use the USGS WaterWatch Customized Rating Curve Builder to get the rating curve for that site at <https://waterwatch.usgs.gov/?id=mkrc>.
- If there is not an existing stage-discharge rating curve for your site, then you will need to build one. This requires measuring stage and discharge at multiple stage levels over time and then creating a stage-discharge curve. A good reference on measuring stage and discharge is at <https://www.usgs.gov/special-topic/water-science-school/science/how-streamflow-measured>.

Once you have enough stage and discharge measurements for your site, you can use those measurements to create the stage-discharge curve for the site. There are two common ways to do this:

- Use a commercially available rating curve software tool, such as AQUARIUS or DataWise.
- Create your own stage-discharge curve fit for your stage-discharge measurements with a spreadsheet, such as Excel, or with a statistical program, such as R. The most common equation used for stage-discharge curves is Manning's Equation.
  - Once you have selected the type of equation to use, try different coefficients in the equation to determine which ones provide the best fit for your stage-discharge measurements.
  - Use the selected equation to determine a set of values to enter in the HOBOLink stage-discharge table. If there are any levels at which there is a significant change in the stream profile, you will need to account for those as well. For example, when a stream overflows its banks, the stage-discharge relationship will change dramatically. The curve fit equation will no longer be

valid so you will need a different curve-fit equation for stage levels in this range.

**Important:** Make sure the station has started logging and you have configured the water level channel with a reference level reading before performing these steps.

To set up a water flow channel using a stage discharge table:

1. Click Devices and then RX Devices, and find the station you want to configure. Click the arrow next to the  and select Module/Sensor Configuration.
2. Under the water level module in the Configuration menu, select Water Flow.
3. Click the checkbox to Enable Channel.
4. Click the checkbox to Enable Graph and type a label (optional).
5. For the Measurement Method, select Stage Discharge Table.
6. Enter each pair of stage-discharge points. Click Add A Row to add up to 20 pairs of points.
  - If you entered the reference water level in meters when setting up the water level channel, then the points in the table must be entered in meters and l/s.
  - If you entered the reference water level in feet when setting up the water level channel, then the points in the table must be entered in feet and cfs.
7. Click Save (or click Next to move to the next configuration page).

Water flow will be calculated starting with the next connection to HOBOLink.

### Starting and Stopping Logging

You can start and stop logging with the Start/Stop button on the station or from HOBOLink.

To start and stop logging with the station:

1. When the station is stopped, press the Start button to start logging. The device will connect to HOBOLink (“Connection” will blink on the LCD) and then logging will begin at the logging interval specified for smart sensors, wireless sensors and analog sensors (if applicable).

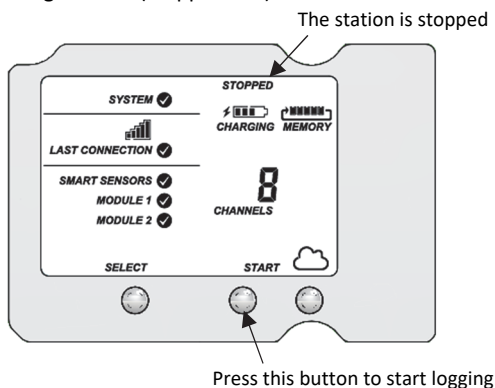

2. To stop logging, press the Stop button. Logging stops immediately. Note that the station will continue to connect to HOBOLink even if it is not logging.

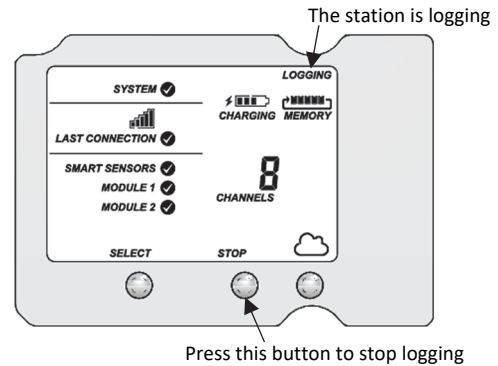

To start and stop the station from HOBOLink:

1. Click Devices, then RX Devices, and find the station you want to start or stop. Click the arrow next to  and select Start/Stop.
2. Click Start or Stop. The station will start or stop logging the next time it connects to HOBOLink.

### Adding or Removing Smart Sensors

To add or remove smart sensors from the station:

1. If the station is currently logging, press the Stop button to stop it.
2. Press the Connect button and wait for the station to connect to HOBOLink so that all the latest data is offloaded before changing smart sensors.
3. If using the rubber cable channel, unscrew the plates and push the cable channel out of the case. Open it to access any smart sensors.
4. Unplug any smart sensors you wish to remove. Plug in any new smart sensors.
5. Press the Select button to view the smart sensors on the LCD screen.
6. Press the Search button for the station to detect all the smart sensors currently connected.
7. Press the Start button to begin logging again. The station will automatically connect to HOBOLink.
8. If using the rubber cable channel, grease and place any smart sensor cables or plugs, reinsert the rubber cable channel, and reinstall the plates. See *Installing the Weatherproof Rubber Cable Channel and Covers* for details.
9. Make any configuration changes in HOBOLink as desired, such as adding sensor labels or scaling (see *Setting up the Station*).

Note that any existing alarms associated with removed sensors will still be listed in HOBOLink. See the HOBOLink Help for details on deleting alarms. Also, if you are using alarms to activate relays, check that the relays are in the proper state.

### Adding or Removing Modules

The RX3000 has two slots in which optional analog, relay, water level sensor, or RXW Manager modules can be installed. You can add or remove these modules as desired.

**To add a module:**

1. Stop the station if it is currently logging.



2. Press the Connect button and wait for the station to connect to HOBOLink so that all the latest data is offloaded before adding a new module.
3. Power down the station (unplug any charging device and then disconnect the battery).
4. Insert the module into the left or right module slot.
5. Using a Phillips-head screwdriver, tighten the screw at the bottom of the module.
6. If you installed a water level sensor module, feed the cable through the top cable access opening and slide the connector at the end of the cable into the receptacle on the module. Insert the cable jack on the other end into the water level sensor and screw on the locking nut (see the steps in *Setting up the Station* for more details).
7. If you installed a RXW Manager module, plug the cable from the RXW Manager mote into the jack on the module, making sure the cable is inserted through the upper cable access opening on the bottom of the station case. Do not reconnect the power on the station until the mote is plugged in as shown.

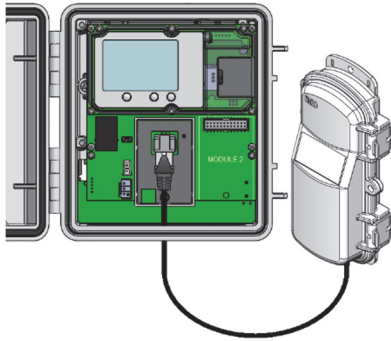

8. Plug in the battery and then the charging device, and wait for the device to power up. Verify that the new module is listed on the LCD screen with a checkmark.
9. The station should automatically connect to HOBOLink (press the Connect button on the station if needed). Check your station's page to make sure the new module is listed.
10. Do the following to complete the setup:
  - Connect any analog sensors or relays (see step 7 in *Setting up the Station* for details).
  - Add any wireless motes (see *Adding or Removing Motes*).
  - If you added a water level sensor module, be sure to obtain a reference water level reading and configure the water level and water flow channels as described in *Setting up the Station* and *Setting up Water Level and Water Flow Channels in HOBOLink*.
  - Make any configuration changes as needed in HOBOLink and start logging again when ready.

**WARNING:** If you inadvertently install modules while the power is on or, you must disconnect and then reconnect the battery and charging device to guarantee proper operation. In addition, if you did not plug the manager mote into the module while the power was off, it may not be recognized by the station. Disconnect and reconnect the battery and charging device.

**To remove a module:**

1. Stop the station if it is currently logging.

2. Press the Connect button and wait for the station to connect to HOBOLink so that all the latest data is offloaded before adding a new module.
3. Power down the station (unplug any charging device and then disconnect the battery).
4. Disconnect any analog sensors, relay devices, or the water level sensor. If removing an RXW Manager module, unplug the RXW Manager mote.
5. Using a Phillips-head screwdriver, unscrew the bottom screw on the module until loosened (it will remain attached to the module).
6. With your fingers on the top and bottom edges of the module, carefully pull it out of the slot.
7. Plug in the battery and then the charging device. Make sure the station connects to HOBOLink (press the Connect button on the station if needed).
8. Make any configuration changes as needed in HOBOLink and start logging again when ready.

**WARNING:** If you inadvertently remove modules while the power is on, you must disconnect and then reconnect the battery and charging device to guarantee proper operation.

Note that any existing alarms associated with removed modules will be listed in HOBOLink. See the HOBOLink Help for details on deleting alarms. Also, if you are using alarms to activate relays, check that the relays are in the proper state.

**Adding or Removing Analog Sensors, Relay Devices, or Water Level Sensors**

Power down the station (unplug any charging device and then disconnect the battery) when adding or removing sensors or devices connected to modules installed in the station.

- If removing a sensor or device, uninstall the cover plate and the rubber cable channel first.
- To add or remove an analog sensor or relay device, see the "Connect analog sensors, relay devices, or water level sensors" step in *Setting up the Station*.
- To remove a water level sensor, press down on the level on the connector shown below and slide the connector out from the receptacle on the module being careful to not put stress on the cable wires.

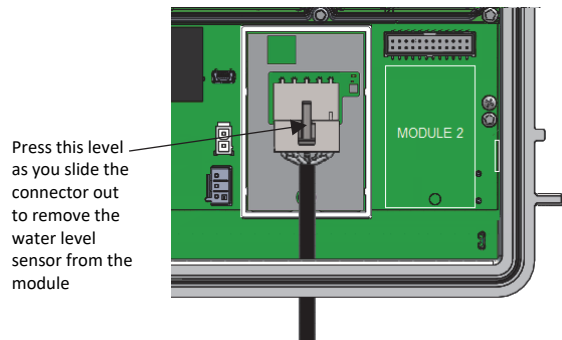

- After adding a sensor or device, be sure to install the rubber cable channel and cover plate before deploying the station (see *Installing the Weatherproof Rubber Cable Channel and Covers*).

**Adding or Removing Motes**

To add a mote to the HOBONet RX Wireless Sensor Network:

**Important:** Keep the mote near the RX3000 station while completing these steps.

1. If the LCD is blank on the RX3000 station, press any button to wake it up.
2. Press the Select button once (which shows the number of smart sensors installed) and then press it again once if the HOBO RXW Manager is installed in the left slot (module 1) or twice if it is installed on the right slot (module 2).

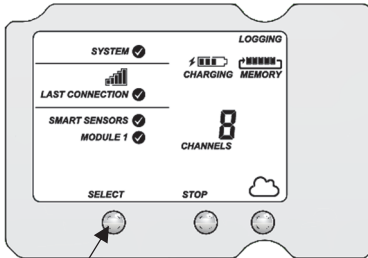

Press this button to view the module where the RXW Manager is installed

3. Press the Search button (the magnifying glass). The magnifying glass icon will blink while the RX3000 is in search mode.

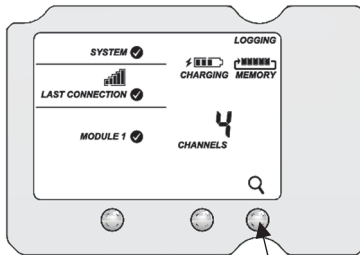

Press this button so the station is ready to have motes join the network

4. Open the mote door and install the batteries if you have not already done so.
5. Press the button on the mote for 3 seconds. The signal strength icon will flash and then cycle.

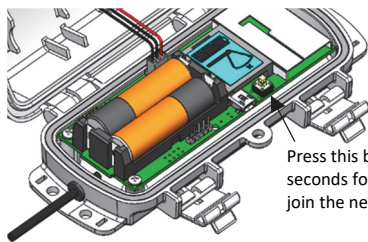

6. Watch the LCD on the mote.



This signal strength icon blinks while searching for a network.



Once a network is found, the icon will stop flashing and the bars will cycle from left to right.



This network connection "x" icon blinks while the mote completes the registration process, which may take up to five minutes.



Once the mote has finished joining the network, the "x" icon is removed and the channel count on the station LCD increases by the number of measurement channels for the mote plus the battery.

The green LED blinks quickly while the mote searches for a network to join and then blinks slowly while it completes the network registration. Once the mote has finished joining the network, the green LED turns off and the blue LED then blinks indefinitely while the mote is part of the network.

**Note:** If the mote cannot find the network or has trouble remaining connected during this process, make sure the mote is in a vertical, upright position and within range of the station.

7. Repeat steps 4–6 for any additional motes to add.
8. Press the Search button (the magnifying glass) on the RX3000 station to stop searching for motes.

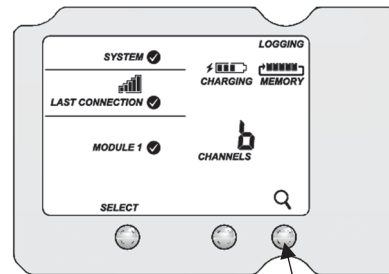

Press this button again to stop searching for motes

Measurements will be recorded at the logging interval specified in HOBOLink, transmitted to the RX3000 station, and uploaded to HOBOLink at the next connection interval (readout).

To remove a mote from the HOBONet RX Wireless Sensor Network:

- a. In HOBOLink, click Devices, then RX Devices, and find the station with the mote you want to delete. Click the arrow next to  and select Module/Sensor Configuration.
- b. Select the mote serial number or name from the Configuration menu as shown in the following example.

**Configuration**

- General
- Readout
- Smart Sensors Logging
  - Temperature
  - RH
  - Dew Point
  - Water Content (test)
  - Temperature (soil)
  - Pressure
- Module 1: Wireless Sensors Logging
  - 20291072
  - 20113725
    - Temperature
    - 20038742
    - Water Content
    - 20109180
    - Water Content
- Battery
- Start/Stop
- Alarms

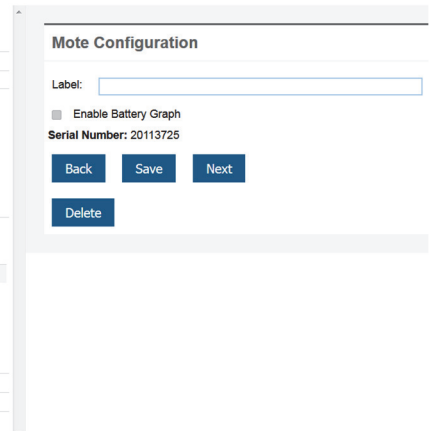

- c. Click Delete to remove the mote from the network.
- d. If the mote you are deleting is currently active on the network (i.e. powered up and transmitting data), the station will need to connect to HOBOLink to complete the removal process. Otherwise, the mote will not officially leave the network and can attempt to automatically rejoin the network in the future. To connect to HOBOLink, press the Connect button on the station. Once the station is connected, a command is sent to the station and the mote permanently leaves the network.

## Managing Connections to HOBOLink

The station will connect to HOBOLink on the connection interval you selected in Readout Configuration.

To change the connection schedule:

1. Click Devices, then RX Devices, and find the station you want to configure. Click the arrow next to  on the Devices page and select Readout Configuration.
2. Set the connection interval. For the RX3003 and RX3004 cellular models, the minimum connection interval depends on your communication plan.
3. If you wish to set up a second connection interval, select the “Night Mode” checkbox. Select when night mode should begin and end and then enter the connection interval you want to use during that part of the day.
4. Click Save. The changes to the connection interval will take place the next time the station connects to HOBOLink.

You can also connect to HOBOLink from the station at any time, regardless of the connection schedule. Press the Connect button on the station to connect to HOBOLink. Unless the station is running on a night mode connection interval, the normal connection schedule will then restart after the connection is complete. For example, a station is configured to connect hourly and the last connection on its regular schedule occurred at 10:05. If you use the Connect button on the station to connect to HOBOLink at 10:15, the next connection will then be about 11:15 based on the one-hour connection interval. Similarly, if a station misses a connection, the connection schedule will shift depending on the time of the next successful connection. While the station is using a second, night mode schedule, all connections will follow that schedule only; any extra connections while the station is in night mode will not cause a shift in the connection schedule.

Also note that the station will connect to HOBOLink when the device is powered up and when you press the Start button.

**For RX3003 and RX3004 cellular models:** All connections to HOBOLink count toward your communications plan. If the station is nearing its limit for monthly cell use, minimize unscheduled connections. This includes any connections for alarms or changes you make to the connection schedule. You can also increase the connection interval to reduce the number of connections to HOBOLink per day. Check the Device Information section on your station page in HOBOLink to check the status of the monthly communications plan usage for the station.

## Checking Latest Conditions with HOBOWare

The RX Station Manager within HOBOWare is available for showing the current sensor readings in an RX3000 Station connected to a computer. To do this:

1. Connect the station to the computer with a USB cable and open HOBOWare.
2. From the Device menu in HOBOWare, select Manage RX Station. Note for Windows: You may see a warning that Windows Firewall has blocked some features. Select Domain networks and click Allow Access.
3. In the RX Station Manager, the Latest Conditions panel shows the currently configured sensors and modules for the device. Click the refresh button  in the Latest Conditions panel to take a measurement for each sensor and display the value. (Note: Sensor readings do not refresh automatically.) You can also view general information about the RX3000 Station in the Device information panel.
4. Close the RX Station Manager when done and disconnect the USB cable.

**Note:** The Latest Conditions and Device Information available in the RX Station Manager are for reference only. Use HOBOLink to view complete station details, access logged data, and configure the device.

## Deploying and Mounting the Station

Follow the guidelines and steps in this section for deploying and mounting the station.

### Guidelines for Deploying the Station

- Check the signal strength on the LCD in the location you wish to deploy the station to make sure it will be able to reliably connect to HOBOLink (RX3002 Wi-Fi and RX3003 and RX3004 cellular models). The station may have difficulty connecting if there is only one bar illuminated in the Wi-Fi or cellular LCD symbol. (The signal strength shown on the LCD is from the last connection.)
- The RX3003 and RX3004 cellular models must be mounted at least one foot from all sensors to avoid interference from the built-in radio module and antenna with the measurements made by the sensors.
- Make sure the station remains in a vertical position once it is placed in its deployment location. If it is mounted horizontally, the battery could be damaged over time as it is charged and the antenna (if applicable) will not have optimal range.
- If you haven't already done so, plug in an AC adapter, solar panel, or other external power source to keep the battery charged.
- If you are using a wind speed/direction sensor or if the station will be installed on a roof or in a location with exposure to lightning, use the grounding wire included with this station and ground the tripod or mast using appropriate grounding, such as the Grounding Kit (M-GKA). A grounding wire may also reduce potential sensor errors that can result from installing near other radio or electrical equipment or antennas. See *Installing the Grounding Wire*.

- Make sure all cables and wires are fastened securely, routed through the cable access openings, and placed in the rubber cable channels. Any empty holes in the cable channels need to be filled with the appropriate size plug to ensure the station is weatherproof. See *Installing the Weatherproof Rubber Cable Channel and Covers*.
- Do not store excess sensor cable wire coiled inside the station case or within one foot outside the case.
- Protect cables and wires with conduit. Exposed cables can be chewed by rodents.
- Make sure the total cable length for all installed smart sensors does not exceed 100 m (328 ft).
- Consider using a padlock to restrict access to the station. With the station door closed, hook a padlock through one of the latches on the right side of the door and lock it.

### Guidelines for Deploying the HOBOnet RX Wireless Sensor Network

- Stay close to the RX3000 station when adding motes to the wireless network because you will need to access both the station and the mote at the same time. After the mote has successfully joined the wireless network, you can then move it to its deployment location.
- Check the signal strength on the mote LCD on the location where you want to place the mote. If there is only one or two bars on the signal strength indicator, consider moving the mote to a location where the signal strength is stronger.
- Consider using a plastic pole such as PVC to mount the motes.
- Make sure motes are mounted a minimum of 1.8 m (6 feet) above the ground or vegetation to help maximize distance and signal strength as shown below.

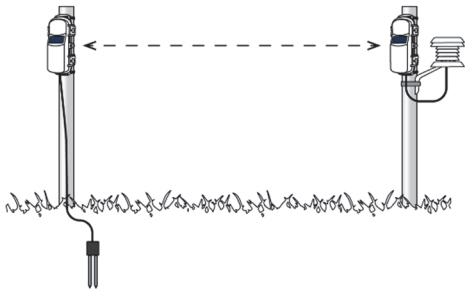

- Make sure each sensor mote and repeater is positioned so that the built-in solar panel receives optimal sunlight throughout each season as shown. It may be necessary to periodically adjust the mote position as the path of the sunlight changes throughout the year or if tree and leaf growth alters the amount of sunlight reaching the solar panel.

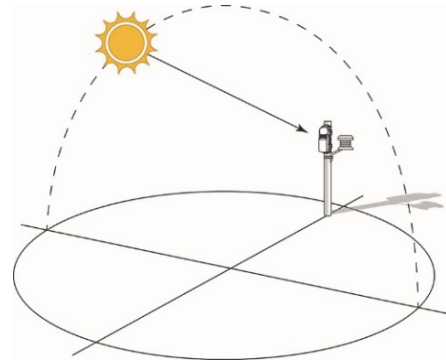

- Obstructions between motes can prevent reliable network communication. If the mote is blocked by a small obstruction (e.g. a pole, the RX3000 station, shrubbery), then move the mote to a location where the obstruction is not blocking the path to the nearest mote. If there is a change in elevation between motes or a large obstruction is in the way (e.g. a building or tree), then either reposition the mote until there is full line of sight to the next mote or add a repeater between them.

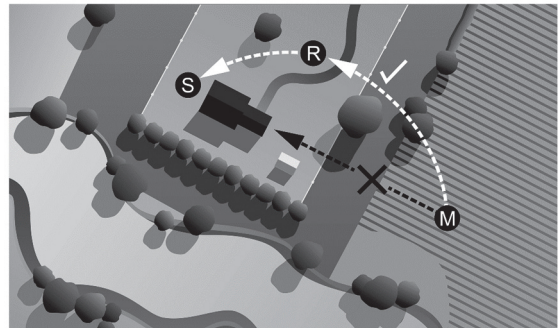

S Station R Repeater M Mote

- There should not be more than five motes in any direction at their maximum transmission range from the RXW Manager. Data logged by a wireless sensor must travel or “hop” across the wireless network from one mote to the next until it ultimately reaches the RXW Manager at the RX3000 station. To make sure the data can successfully travel across the network, the mote should not be more than five hops away from the manager.
- Use the Map feature in HOBOLink for a bird’s eye view of the network and wireless paths. See the HOBOLink Help for details on this and other ways to monitor the status of your network and sensor data.
- Use cable ties or screws to mount the mote via the holes on the mounting tabs.
- Make sure the mote remains in a vertical position once it is placed in its deployment location for optimal network communications.
- Make sure the mote door is closed, with both latches fully locked to ensure a watertight seal.
- Consider using a 3/16 inch padlock to restrict access to the mote. With the mote door closed, hook a padlock through the eyelet on the right side of the door and lock it.
- Mount the manager as high as possible above the RX3000 station to increase the radio signal and line of sight.

## Guidelines for Deploying a Water Level Sensor

If a water level sensor module (RXMOD-W1) is installed in the station, follow these guidelines when deploying the water level sensor:

- The absolute pressure sensor in the water level sensor is temperature compensated over the range of 0° to 40°C (32° to 104°F). The barometric pressure sensor is temperature compensated over the range of -20° to 50°C (-4° to 122°F). To obtain the highest level of accuracy, both the sensor and station should be allowed to come to full temperature equilibrium (approximately 20 minutes) before the reference level is entered in HOBOLink as described in *Setting up the Station*.
- Sudden temperature changes should be avoided.
- When deploying the water level sensor in a well, make sure the well is vented to the atmosphere. Typically, a small hole can be drilled in the side of the well cap to ensure that the pressure inside and outside the well is at equilibrium. Use the Onset well cap (WELL-CAP-02) if it is a 5 cm (2 inch) well. Otherwise, you will need to find another method of attaching the cable at the top of your well so that the sensor stays in position. The sensor cable includes a Kevlar® strength member so it can support the weight of the sensor and its cable. You can attach a clamp around the cable, such as a hose clamp, but be careful not to damage the cable.
- Make sure the vent on the side of the station does not collect water, which will block proper barometric pressure readings. The best way to avoid water collecting is to mount the station vertically.
- The sensor face located in the nose cone of the sensor end needs to be in the water to measure water level.

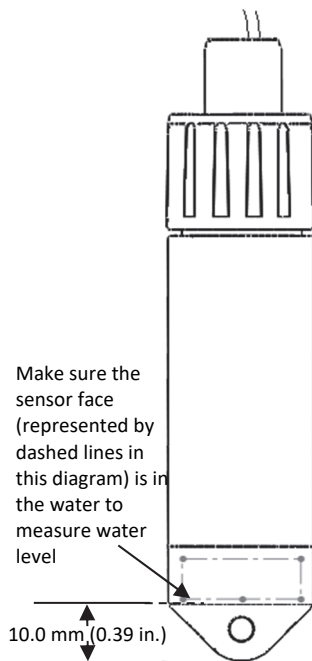

- Any change in length of the sensor cable will result in a 1-to-1 corresponding error in the depth measurement. Always pull-test a cable prior to deploying a logger in a well to make sure it does not stretch.
- If you are deploying the sensor in a lake, river, or stream, you must first build a stilling well to protect it and the

cable. A simple stilling well can be constructed with PVC or ABS pipe. A properly constructed stilling well holds the sensor in position and protects the sensor from currents, wave action, and debris. Suspend the sensor in the stilling well so it is always underwater, but not on the bottom to be buried by silt.

For more information, see the Technical Application Note for Constructing a Stilling Well at:

<https://www.onsetcomp.com/resources/tech-notes/constructing-stilling-well>

- To prevent the sensor from moving in currents and to ensure the support cable is kept straight during deployment, you may need to add a weight to the suspension cable just above the sensor or hang a weight below the sensor. In some cases, you may need to both add a weight and use a stilling well.
- Be very careful not to exceed the burst pressure for the sensor. The pressure sensor will burst if the maximum depth is exceeded (see *Specifications*). The sensor should be positioned at a depth where it will remain in the water for the duration of the deployment, but not exceed the rated bursting depth.
- If the cable is too long, loop the cable and secure the cable with multiple zip ties to ensure the loop does not slip. The looped cable should be tight enough that the cable can be easily pulled out of the well if necessary, but it must not bend the cable any tighter than a 1.25 cm (0.5 inch) radius to prevent damage to the cable.

## Installing the Grounding Wire

Insert the grounding wire through the larger of the two cable access openings and plug it into the ground connector. You may need pliers to connect it to the station. The grounding wire must be connected to a properly grounded mast (typically on one side of the U-bolt) when the station is mounted.

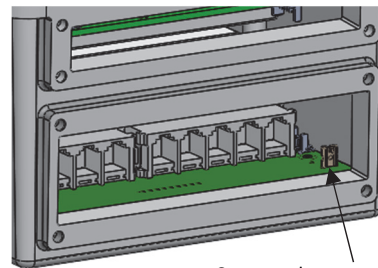

## Mounting the Station

Attach the mounting plates with a Phillips-head screwdriver to the back of the station to mount it on a flat surface. Mount the station vertically to a wall or board using screws.

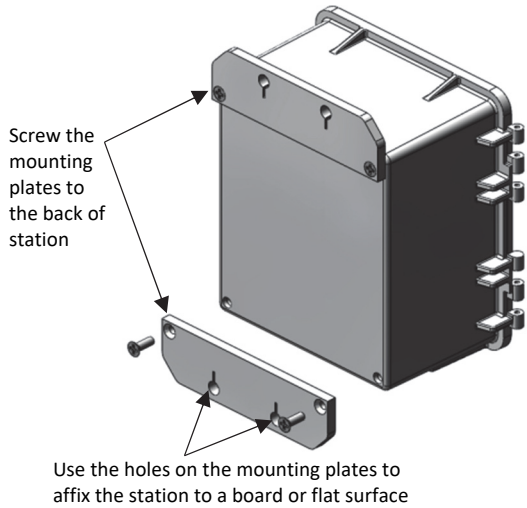

You can also mount the station vertically to a mast or pole and tripod using U-bolts (unscrew the nut on the U-bolt to place around the mast or pole). Screw the mounting plates to the back of the station as shown above. Make sure the mounting plates are mounted against the flat part of the U-bolt saddle clamps. If using the grounding wire, attach it to one end of the U-bolt. Refer to the *Tripod Setup Guide* for full details.

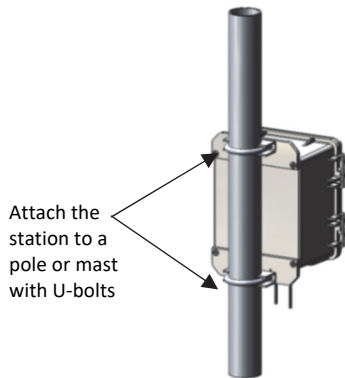

### Installing the Weatherproof Rubber Cable Channel and Covers

**Important:** This is required for outdoor and weatherproof deployments and recommended for harsh indoor environments where debris could enter the station.

1. Make sure all sensors and cables are installed, including the solar panel, AC adapter cable, or external DC power cable, and the grounding wire.
2. If a water level sensor module is installed, you will need to use the rubber cable channel packaged with the water level sensor module rather than the smaller of the two rubber cable channels from the RX3000 Channel Kit packaged with the station.
3. Grease one of the two rubber cable channels.
  - a. Apply a small amount of silicone grease (about the size of a pea) onto your fingertip.
  - b. Lightly coat all four outer edges on the rubber cable channel with grease.
  - c. Open the cable channel and lightly coat the inside of both halves (the part with the grooves).
4. Lightly coat the portion of each cable that will be in the channel with grease.

5. Position the cable channel around the cables, routing the cables through the proper grooves.
  - a. Open the greased rubber cable channel so that the channel's hinged side is oriented to the left.
  - b. Place each cable or wire into a single groove in the cable channel, installing them from left to right.
    - For the large cable channel, place smart sensor cables in the grooves. If using the grounding wire, place the black portion of it into the rightmost hole in the cable channel (the hole farthest from the hinged side).

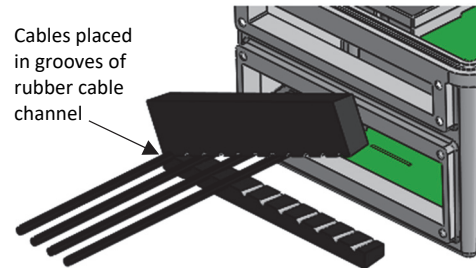

- If you are using the small cable channel that was shipped with the RX3000 station (not the cable channel shipped with the water level sensor module), place the AC adapter or solar panel cable and any analog sensor cables or relay wires in each of the grooves. Place larger cables in the five grooves on the left closest to the hinged side and smaller cables in the five grooves on the right.
- If you are using the small cable channel that was shipped with the water level sensor module (not the cable channel shipped with the station), place the water level sensor cable in one of the two medium holes. Place the AC adapter or solar panel cable and any analog sensor cables or relay wires in each of the remaining grooves, with larger cables in the four largest grooves and smaller cables in the four smallest grooves.

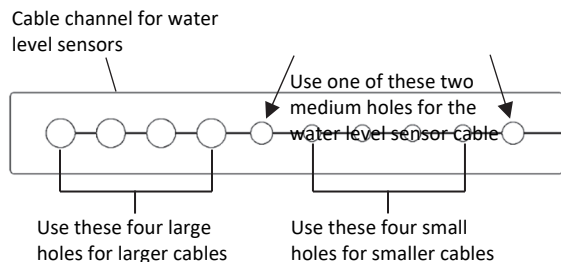

**Important:** The cable diameter must be 4.0 mm (0.156 in.) to fit through one of the smaller holes or 6.4 mm (0.25 in.) to fit through one of the larger holes in the rubber cable channel. If the cable diameter is too small, build up the diameter using heat shrink. If the cable is too big, splice on another cable with a smaller diameter to fit through the hole. If you are using the rubber cable channel designed for the water level sensor, reserve the medium holes for the water level sensor cable.

6. Close the rubber cable channel making sure the cables and wires remain in their grooves.
7. Press the cable channel into the opening until it is flush with the outside of the case (when fully seated, the channel will project slightly into the inside of the case). To reduce the

amount of excess cable in the case, gently pull the cables toward you as you press the channel into place.

8. Using thumbscrews, install the plate on the cable access opening to hold the rubber cable channel in place. (Use the smaller plate for the top opening and the larger plate for the larger opening.) *Do not fully tighten the thumbscrews yet*; keep them loosely installed while you install the rubber plugs in the next step.
9. Lightly coat rubber plugs with a small amount of grease and use the plugs to fill any empty holes in the two cable channels. Insert the thin part of the plug into the hole and push it in until the thick part of the plug fills the hole. Use the large plugs in the larger holes and the small plugs in the smaller holes. If you are using the rubber cable channel designed for the water level sensor, then use one of the medium plugs included with the water level sensor module to fill an empty medium-sized hole.

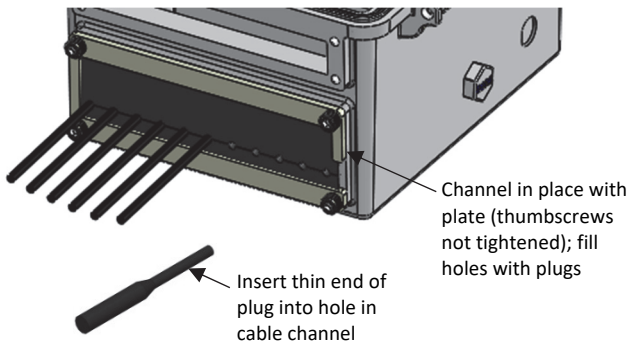

10. Repeat steps 2 through 9 with the other rubber cable channel.
11. Use the included wrench to tighten the four thumb screws on each of the two plates until the plates are flat against the case.

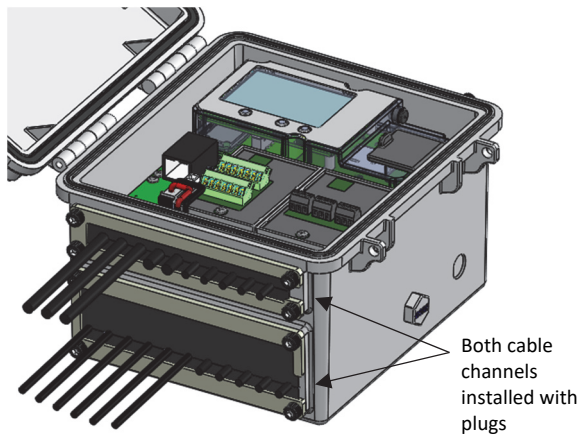

### Care and Maintenance

The station is designed for outdoor use, but should be inspected periodically. When inspecting the station, do the following:

- Verify the station enclosure and any wireless sensor motes are free of visible damage or cracks.
- Make sure the station or mote enclosure is clean. Wipe any dust or grime off with a damp cloth.
- Wipe any water off the station or mote before opening it.

- Check that all cables and wires are free of damage, such as cracks, cuts, and splits.
- Make sure cables and wires are still fastened securely and any conduit is still intact.
- Verify that all cables and wires are free of corrosion. If moisture is visible inside the station or if there is any sign of corrosion on the connectors, spray WD-40® or an equivalent electronics-safe corrosion inhibitor on the connectors. This will displace moisture and prevent additional corrosion. Be sure to determine the source of the moisture and fix it. Check the cable channel and cover seals for any sign of moisture entry.
- Make sure any interior seals or cable channels are intact and the latches are fully locked when the station and any mote doors are closed.

### Troubleshooting

Error codes can appear on the LCD if a problem arises with the station or a sensor. This table describes common error codes that may appear. Contact Onset Technical Support for help.

Fault Code #	Description	Action to Take
001	System Failed Initialization	Power cycle the station (disconnect the battery and charging device, wait for a minute, and then plug the battery and charging device back in).
004	Sensor Error/Fault	Check the smart sensor data in HOBOLink to see which smart sensor is producing an error. You may need to remove or replace the smart sensor if the smart sensor is consistently reporting erroneous data.
036	Missing Module	A previously installed module has gone missing. Power cycle the station (disconnect the battery and charging device, wait for a minute, and then plug the battery and charging device back in).
037	Module Improperly Installed	The station must be powered off when installing a module to guarantee proper operation. Power cycle the station (disconnect the battery and charging device, wait for a minute, and then plug the battery and charging device back in).
129	Smart Sensor Bus Fault	There is a problem with one or more of the smart sensor connections. Check that all smart sensors are fully plugged in (follow the instructions in <i>Adding or Removing Smart Sensors</i> ). Also check that the smart sensor cables are ok.
132	Analog Excitation Bus Fault	Check the analog sensor connection and the excitation settings for the sensor in HOBOLink.

### Battery Information

The station uses one rechargeable 4 volt, 10Ah, sealed lead-acid battery. Use the AC adapter (AC-U30), solar panel (SOLAR-xW), or external DC power cable (CABLE-RX-PWR) with your own charging device to keep the battery charged. If using a solar panel, the quality and quantity of solar light can affect

whether the battery is sufficiently charged to last through the night and cloudy periods. Without a charging device connected, expected battery life varies based on the ambient temperature where the station is deployed, the logging or sampling interval, frequency of connections to HOBOLink, the number of channels that are active, excitation in analog modules, the number of tripped alarms, and other factors. Deployments in extremely cold or hot temperatures, a logging interval faster than 1 minute, or a sampling interval faster than 15 seconds can impact battery life. Estimates are not guaranteed due to uncertainties in initial battery conditions and operating environment.

Use the following table as a guideline for estimating how long the station will run using a fully charged battery and no source of external power. For these examples, the station has up to 10 smart sensors installed and no excitation enabled for the analog sensor module.



Connection Interval	Logging Interval	Typical Run Time
10 minutes	1 minute	20 days
1 hour	15 minutes	50 days
6+ hour	30 minutes	75 days

All communications will stop if the battery voltage drops below 3.9 V. The station will stop logging if the battery voltage drops below 3.6 V. If the station has stopped logging due to low battery voltage, plug in an AC adapter, solar panel, or external power source to recharge it. It may take several minutes for the station to power back up; the lower the remaining voltage, the longer it will take for power to return. Also note that it will take longer for power to return with a solar panel than with an AC adapter. If the charging device is not recharging a dead battery, contact Onset Technical Support.

**Important:** Due to the self-discharge characteristics of this type of battery, it is imperative that you charge the battery for at least 12 hours every six months at minimum, even if you are not actively using the station. Otherwise, permanent loss of battery capacity may occur.

For information on mote batteries, refer to the wireless sensor or repeater manual at [www.onsetcomp.com/resources](http://www.onsetcomp.com/resources).



**DANGER! HIGH VOLTAGE HAZARD!**

This station can be used with sensors that may be installed in an energized electrical enclosure or on an energized conductor. Installation of sensors in an energized electrical enclosure or on an energized conductor can result in severe injury or death. These sensors are for installation by qualified personnel only. To avoid electrical shock, do not install or service these sensors unless you are qualified to do so. Disconnect and lock out all power sources during installation and servicing. Please read the sensor users' manuals for instructions and use.

**WARNING**

This station contains a radio and is not approved for use on airplanes. Disconnect the battery and all power sources before flight.

#### Federal Communication Commission Interference Statement

This equipment has been tested and found to comply with the limits for a Class B digital device, pursuant to Part 15 of the FCC Rules. These limits are designed to provide reasonable protection against harmful interference in a residential installation. This equipment generates uses and can radiate radio frequency energy and, if not installed and used in accordance with the instructions, may cause harmful interference to radio communications. However, there is no guarantee that interference will not occur in a particular installation. If this equipment does cause harmful interference to radio or television reception, which can be determined by turning the equipment off and on, the user is encouraged to try to correct the interference by one of the following measures:

- Reorient or relocate the receiving antenna
- Increase the separation between the equipment and receiver
- Connect the equipment into an outlet on a circuit different from that to which the receiver is connected
- Consult the dealer or an experienced radio/TV technician for help

This device complies with Part 15 of the FCC Rules. Operation is subject to the following two conditions: (1) This device may not cause harmful interference, and (2) this device must accept any interference received, including interference that may cause undesired operation.

**FCC Caution:** Any changes or modifications not expressly approved by the party responsible for compliance could void the user's authority to operate this equipment.

#### Industry Canada Statements

This device complies with Industry Canada license-exempt RSS standard(s). Operation is subject to the following two conditions: (1) this device may not cause interference, and (2) this device must accept any interference, including interference that may cause undesired operation of the device.

#### Avis de conformité pour l'Industrie Canada

Le présent appareil est conforme aux CNR d'Industrie Canada applicables aux appareils radio exempts de licence. L'exploitation est autorisée aux deux conditions suivantes : (1) l'appareil ne doit pas produire de brouillage, et (2) l'appareil doit accepter tout brouillage radioélectrique subi, même si le brouillage est susceptible d'en compromettre le fonctionnement.

To comply with FCC and Industry Canada RF radiation exposure limits for general population, the logger must be installed to provide a separation distance of at least 20cm from all persons and must not be co-located or operating in conjunction with any other antenna or transmitter.

#### NCC Statement

經型式認證合格之低功率射頻電機，非經許可，公司、商號或使用者均不得擅自變更頻率、加大功率或變更原設計之特性及功能。

低功率射頻電機之使用不得影響飛航安全及干擾合法通信；經發現有干擾現象時，應立即停用，並改善至無干擾時方得繼續使用。前項合法通信，指依電信法規定作業之無線電通信。低功率射頻電機須忍受合法通信或工業、科學及醫療用電波輻射性電機設備之干擾。

#### Translation:

#### Article 12

Without permission granted by the NCC, any company, enterprise, or user is not allowed to change frequency, enhance transmitting power or alter original characteristic as well as performance to an approved low power radio-frequency device.

#### Article 14

The low power radio-frequency devices shall not influence aircraft security and interfere with legal communications. If found, the user shall cease operating immediately until no interference is achieved. The said legal communications means radio communications is operated in compliance with the Telecommunications Act. The low power radio-frequency devices must be susceptible with the interference from legal communications or ISM radio wave radiated devices.

「減少電磁波影響，請妥適使用」

#### KC Statement

해당 무선설비는 전파혼신 가능성이 있으므로 인명안전과 관련된 서비스는 할 수 없음

#### Translation:

The service related to human safety is not allowed because this device may have the possibility of the radio interference.