



# CableIQ<sup>TM</sup>

Qualification Tester

## Users Manual

January 2005, Rev. 6/6/2018  
© 2005, 2007, 2009, 2015-2018 Fluke Corporation  
All product names are trademarks of their respective companies.

## LIMITED WARRANTY AND LIMITATION OF LIABILITY

Each Fluke Networks product is warranted to be free from defects in material and workmanship under normal use and service unless stated otherwise herein. The warranty period for the mainframe is one year and begins on the date of purchase. The CableIQ remote unit is also warranted for one year. Parts, accessories, product repairs and services are warranted for 90 days, unless otherwise stated. Ni-Cad, Ni-MH and Li-Ion batteries, cables or other peripherals are all considered parts or accessories. The warranty extends only to the original buyer or end user customer of a Fluke Networks authorized reseller, and does not apply to any product which, in Fluke Networks' opinion, has been misused, abused, altered, neglected, contaminated, or damaged by accident or abnormal conditions of operation or handling. Fluke Networks warrants that software will operate substantially in accordance with its functional specifications for 90 days and that it has been properly recorded on non-defective media. Fluke Networks does not warrant that software will be error free or operate without interruption.

Fluke Networks authorized resellers shall extend this warranty on new and unused products to end-user customers only but have no authority to extend a greater or different warranty on behalf of Fluke Networks. Warranty support is available only if product is purchased through a Fluke Networks authorized sales outlet or Buyer has paid the applicable international price. To the extent permitted by law, Fluke Networks reserves the right to invoice Buyer for repair/replacement when a product purchased in one country is submitted for repair in another country.

For a list of authorized resellers, visit [www.flukenetworks.com/wheretobuy](http://www.flukenetworks.com/wheretobuy).

Fluke Networks warranty obligation is limited, at Fluke Networks option, to refund of the purchase price, free of charge repair, or replacement of a defective product which is returned to a Fluke Networks authorized service center within the warranty period. To obtain warranty service, contact your nearest Fluke Networks authorized service center to obtain return authorization information, then send the product to that service center, with a description of the difficulty, postage and insurance prepaid (FOB destination). Fluke Networks assumes no risk for damage in transit. Following warranty repair, the product will be returned to Buyer, transportation prepaid (FOB destination). If Fluke Networks determines that failure was caused by neglect, misuse, contamination, alteration, accident or abnormal condition of operation or handling, or normal wear and tear of mechanical components, Fluke Networks will provide an estimate of repair costs and obtain authorization before commencing the work. Following repair, the product will be returned to the Buyer transportation prepaid and the Buyer will be billed for the repair and return transportation charges (FOB Shipping point).

**THIS WARRANTY IS BUYER'S SOLE AND EXCLUSIVE REMEDY AND IS IN LIEU OF ALL OTHER WARRANTIES, EXPRESS OR IMPLIED, INCLUDING BUT NOT LIMITED TO ANY IMPLIED WARRANTY OF MERCHANTABILITY OR FITNESS FOR A PARTICULAR PURPOSE. FLUKE NETWORKS SHALL NOT BE LIABLE FOR ANY SPECIAL, INDIRECT, INCIDENTAL OR CONSEQUENTIAL DAMAGES OR LOSSES, INCLUDING LOSS OF DATA, ARISING FROM ANY CAUSE OR THEORY.**

Since some countries or states do not allow limitation of the term of an implied warranty, or exclusion or limitation of incidental or consequential damages, the limitations and exclusions of this warranty may not apply to every buyer. If any provision of this Warranty is held invalid or unenforceable by a court or other decision-maker of competent jurisdiction, such holding will not affect the validity or enforceability of any other provision.

4/15-CIQ

Fluke Networks  
PO Box 777  
Everett, WA 98206-0777  
USA

# Table of Contents

Title	Page
Overview of Features.....	1
Registration.....	2
Contacting Fluke Networks.....	2
Additional Resources for Cable Testing Information.....	3
Unpacking.....	3
CableIQ Advanced IT Kit (CIQ-KIT).....	3
CableIQ Qualification Tester (CIQ-100).....	4
CableIQ Copper and Fiber Technician's Kit (CIQ-FTKSFP).....	4
 Symbols and Safety Information.....	5
Physical Features.....	8
Using the Wiremap Adapter and Remote ID Locators.....	10
Powering the Tester.....	11
Verifying Operation.....	11

Setting User Preferences .....	11
Changing the Language and Length Units .....	11
Setting the Time and Date .....	12
Entering User Information .....	12
Auto Shutoff .....	14
Enabling or Disabling the Speaker .....	14
Resetting to Factory Settings .....	14
Checking the Hardware and Software Versions .....	15
Qualifying Cabling with the Autotest .....	15
Selecting Tests to Run.....	18
Autotest on Twisted Pair Cabling .....	19
Connecting to Star Topologies.....	20
Connecting to Bus Topologies.....	22
About Qualification for VoIP (Voice Over Internet Protocol).....	22
Autotest Results for Twisted Pair Cabling .....	24
Wiremap Results .....	25
Signal Performance Results .....	28
Length Results.....	30
Autotest on Coaxial Cabling (75 $\Omega$ ) .....	32
Discovering Cabling Characteristics .....	37
Discover Mode Results for Twisted Pair Cabling .....	38
Discover Mode Results for Coaxial Cabling .....	42
TDR Plot for Coaxial Cabling .....	44
Using Multiple Remote ID Locators in Discover Mode (MultiMap™).....	46
Using the Toner .....	48

Using the IntelliTone Cable Map Function .....	50
Blinking a Port Light .....	51
Testing for Continuity.....	52
Using the Continuity Toner.....	54
Locating Crosstalk and Impedance Faults on Twisted Pair Cabling .....	56
Testing Speaker Cabling .....	58
Calibrating Length Measurements.....	60
Setting the NVP to a Specified Value .....	60
Determining a Cable’s Actual NVP .....	61
Memory Functions .....	62
Viewing Saved Results .....	62
Deleting Results.....	62
Uploading Results to a PC.....	62
Maintenance .....	63
Updating the Tester’s Software.....	63
Replacing the Batteries.....	64
Cleaning.....	65
If Something Seems Wrong .....	65
Options and Accessories .....	67
Specifications.....	68
Environmental Specifications .....	68
General Specifications.....	69
Performance Specifications.....	70
Regulatory Information .....	71
Appendix A: Diagnosing Cabling Faults .....	73
Index .....	79



# List of Figures

Figure	Title	Page
1.	Examples of Voltage Alert Screens .....	7
2.	Features .....	8
3.	Using the Universal Adapter for Confined Areas .....	10
4.	Editing Text .....	13
5.	Autotest Setup Screens .....	18
6.	Autotest Connections for Twisted Pair Network Cabling .....	20
7.	Autotest Connections for Telephone Cabling in a Star Topology .....	21
8.	Autotest Connections for Telephone Cabling in a Bus Topology .....	23
9.	Autotest Summary Screens .....	24
10.	Typical Wiremap Screens .....	25
11.	Signal Performance Results .....	28
12.	Length Result Screens .....	30
13.	Autotest Connections for Coaxial Cabling (cabling with splitter shown) .....	33
14.	Autotest Results for Coaxial Cabling .....	34
15.	Discover Mode Results for Twisted Pair Cabling .....	38
16.	Discover Mode Results for Coaxial Cabling .....	42
17.	TDR Plots for Coaxial Cabling .....	44

18.	MultiMap Results.....	46
19.	Using Multiple Remote ID Locators .....	47
20.	Using the Toner (twisted pair example).....	49
21.	Using the Toner with the IP 200IntelliTone Cable Map Function .....	50
22.	Blinking a Port Light.....	51
23.	Testing for Continuity .....	53
24.	Using the Continuity Toner to Test Security Switches .....	55
25.	Testing Speaker Cabling.....	59
26.	Replacing the Batteries .....	65



# List of Tables

<b>Table</b>	<b>Title</b>	<b>Page</b>
1.	International Electrical Symbols .....	5
2.	Autotest Parameters .....	17
3.	Crosstalk and Impedance Fault Messages .....	57
4.	Troubleshooting the Tester .....	66
5.	Options and Accessories .....	67



# CableIQ Qualification Tester

## Overview of Features

The CableIQ™ Qualification Tester is a hand-held tester that lets you test wiring and qualify the transmission capabilities of twisted pair and 75 Ω coaxial cabling installations.

The tester offers the following features:

- Autotest function qualifies cabling for Ethernet, telephone, or CATV service in less than 4 seconds.
- Identifies wiremap faults, bridge taps, and port characteristics.
- Discover mode automatically reports cable characteristics and tells you if the cable is connected to a device.
- Detects and displays the strength of RF coaxial television signals.
- MultiMap™ function tests multiple segments through bridge taps and detects faults on individual conductors.
- Detects Ethernet service on twisted pair cabling and television service on coaxial cabling.
- Locates crosstalk faults on twisted pair cabling and impedance faults on twisted pair and coaxial cabling.
- IntelliTone™ function works with Fluke Networks ITK100 or ITK200 probes to help you locate and isolate cables behind walls, at patch panels, or in bundles. Toner function also works with standard analog probes.
- Continuity toner simplifies testing of security switches at doors and windows.
- Blinks the port light on a hub or switch to help you verify connectivity and cable routing.
- Speaker test lets you quickly verify speaker connections.

- Saves up to 250 Autotest results in internal memory.
- Runs for 20 to 30 hours during typical use. Powered by 4 AA alkaline batteries.
- Multi-language display supports English, French, German, Italian, Portuguese, Spanish, and Japanese (katakana).
- CableIQ Reporter software lets you upload test results to a PC and create professional-quality test reports.

## Registration

Registering your product with Fluke Networks gives you access to valuable information on product updates, troubleshooting tips, and other support services. To register, fill out the online registration form on the Fluke Networks website at

[www.flukenetworks.com/registration](http://www.flukenetworks.com/registration).

## Contacting Fluke Networks

### Note

*If you contact Fluke Networks about your tester, have the tester's software and hardware version numbers available if possible.*



[www.flukenetworks.com](http://www.flukenetworks.com)



[info@flukenetworks.com](mailto:info@flukenetworks.com)



+1-425-446-5500

- Australia: 61 (2) 8850-3333 or 61 (3) 9329 0244
- Beijing: 86 (10) 6512-3435
- Brazil: 11 3759 7600
- Canada: 1-800-363-5853
- Europe: +31-(0) 40 2675 600
- Hong Kong: 852 2721-3228
- Japan: 03-6714-3117
- Korea: 82 2 539-6311
- Singapore: 65-6799-5566
- Taiwan: (886) 2-227-83199
- USA: 1-800-283-5853
- Anywhere in the world: +1-425-446-5500

Visit our website for a complete list of phone numbers.

## Additional Resources for Cable Testing Information

The Fluke Networks Knowledge Base answers common questions about Fluke Networks products and provides articles on cable testing techniques and technology. To access the Knowledge Base, log on to [www.flukenetworks.com](http://www.flukenetworks.com), then click **SUPPORT > Knowledge Base** at the top of the page.

## Unpacking

The tester comes with the accessories listed below. If something is damaged or missing, contact the place of purchase immediately.

For the latest list of options and accessories visit the Fluke Networks website at [www.flukenetworks.com](http://www.flukenetworks.com).

### *Note*

*CableIQ Reporter software is available on the Fluke Networks website*

## CableIQ Advanced IT Kit (CIQ-KIT)

- CableIQ Qualification Tester with detachable wire map adapter
- Four AA alkaline batteries
- IP200 IntelliTone tone probe
- 9 V battery
- Six remote ID adapters, ID numbers 2 through 7
- Two patch cords, 8-pin modular plug to 8-pin modular plug (RJ45 to RJ45), 2 m
- Patch cord, 6-pin modular plug to 6-pin modular plug (RJ11 to RJ11), 15.2 cm
- Coaxial patch cord, F-connector to F-connector, 75  $\Omega$ , 1.5 m
- Universal adapter, 8-pin/4-pin modular jack to 8-pin/4-pin modular jack
- F-connector barrel adapter
- USB cable for PC communications
- Folding pouch for accessories
- Hard carrying case
- Getting Started Guide
- CD-ROM with CableIQ Reporter software and product manuals

#### CableIQ Qualification Tester (CIQ-100)

- CableIQ Qualification Tester with detachable wire map adapter
- Four AA alkaline batteries
- Two patch cords, 8-pin modular plug to 8-pin modular plug (RJ45 to RJ45), 2 m
- F-connector barrel adapter
- USB cable for PC communications
- Carrying case
- Getting Started Guide
- CD-ROM with CableIQ Reporter software and product manuals





#### CableIQ Copper and Fiber Technician's Kit (CIQ- FTKSFP)



- CableIQ Advanced IT Kit (CIQ-KIT)
- SimpliFiber Pro Fiber Test Kit (FTK 1000):
  - SimpliFiber Pro optical power meter
  - SimpliFiber Pro 850/1300 source
  - Four AA alkaline batteries
  - USB cable for PC communications
  - Carrying case
  - Getting Started Guide

## ⚠ Symbols and Safety Information

Table 1 describes the international electrical symbols used on the tester and in this manual.

**Table 1. International Electrical Symbols**

	Warning or Caution: Risk of damage or destruction to equipment or software. See explanations in the manual.
	Warning: Risk of electric shock.
	Consult the user documentation
	This equipment not for connection to public communications networks, such as active telephone systems.
	This product complies with the WEEE Directive marking requirements. The affixed label indicates that you must not discard this electrical/electronic product in domestic household waste. Product Category: With reference to the equipment types in the WEEE Directive Annex I, this product is classed as category 9 "Monitoring and Control Instrumentation" product. Do not dispose of this product as unsorted municipal waste. To return unwanted products, contact the manufacturer's web site shown on the product or your local sales office or distributor.

	40 year Environment Friendly Use Period (EFUP) under China Regulation - Administrative Measure on the Control of Pollution Caused by Electronic Information Products. This is the period of time before any of the identified hazardous substances are likely to leak out, causing possible harm to health and the environment.
	Conforms to relevant Australian standards.
	MSIP-REM-FLK-016005052: EMC approval for Korea  Class A Equipment (Industrial Broadcasting & Communication Equipment)  This product meets requirements for industrial (Class A) electromagnetic wave equipment and the seller or user should take notice of it. This equipment is intended for use in business environments and is not to be used in homes.

### ⚠ Warning ⚠

To avoid possible fire, electric shock, or personal injury:

- Do not open the case; no user-serviceable parts are inside.
- Do not modify the tester.
- Do not use the tester if it is damaged. Inspect the tester before use.

- If this equipment is used in a manner not specified by the manufacturer, the protection provided by the equipment may be impaired.
- The tester is not intended to be connected to active telephone inputs, systems, or equipment, including ISDN devices. Exposure to the voltages applied by these interfaces may damage the tester and create a potential shock hazard for the user.
- If the tester detects voltage, it shows a screen that includes the voltage alert symbol (). Figure 1 shows examples of these screens. Disconnect the tester if the voltage alert symbol appears.
- Always turn on the tester before connecting it to a cable. Turning the tester on activates the tool's input protection circuitry.
- Do not use the tester if it operates abnormally. Protection may be impaired.
- Read the safety information given in the Safety Information booklet before using the tester.

### Caution

To avoid data loss and to ensure maximum accuracy of test results:

- Never attempt to send data from a PC to the tester while running a cable test.
- Never operate portable transmitting devices, such as walkie-talkies and cell phones, during a cable test.
- Replace the batteries as soon as the low battery message appears.



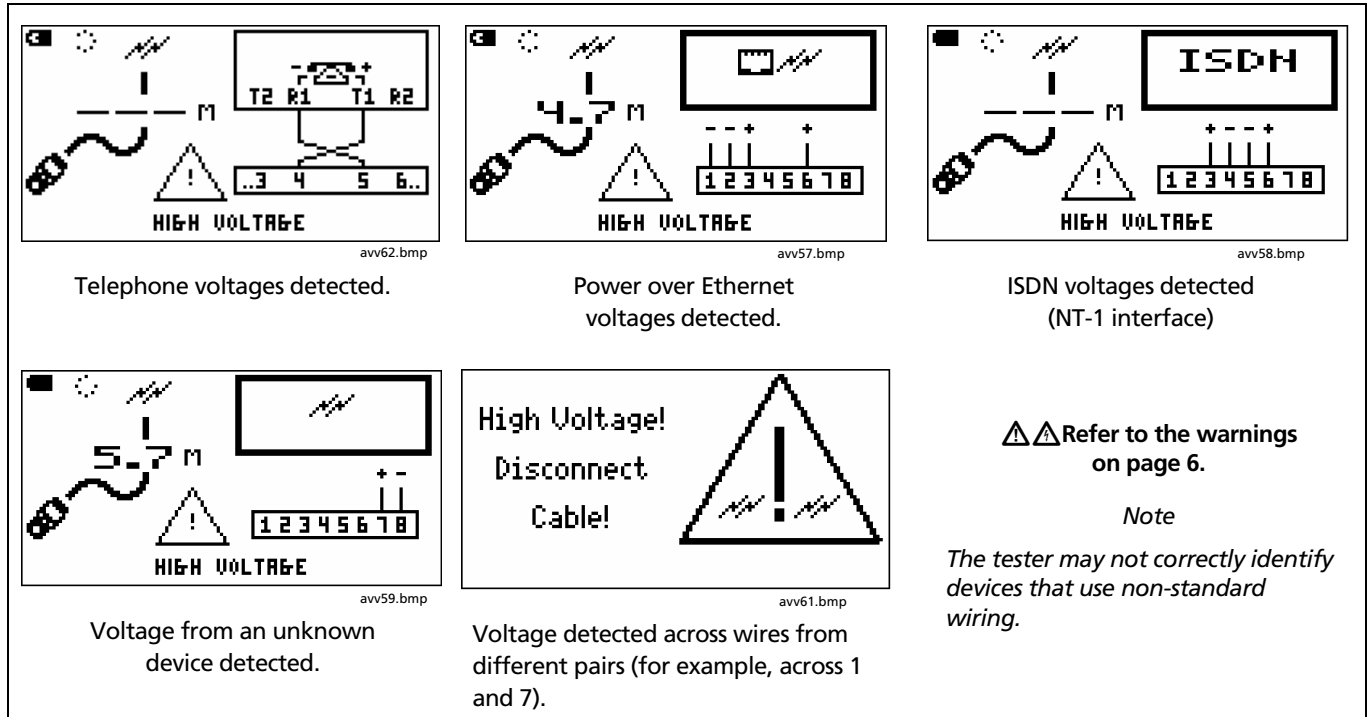

Figure 1. Examples of Voltage Alert Screens

## Physical Features

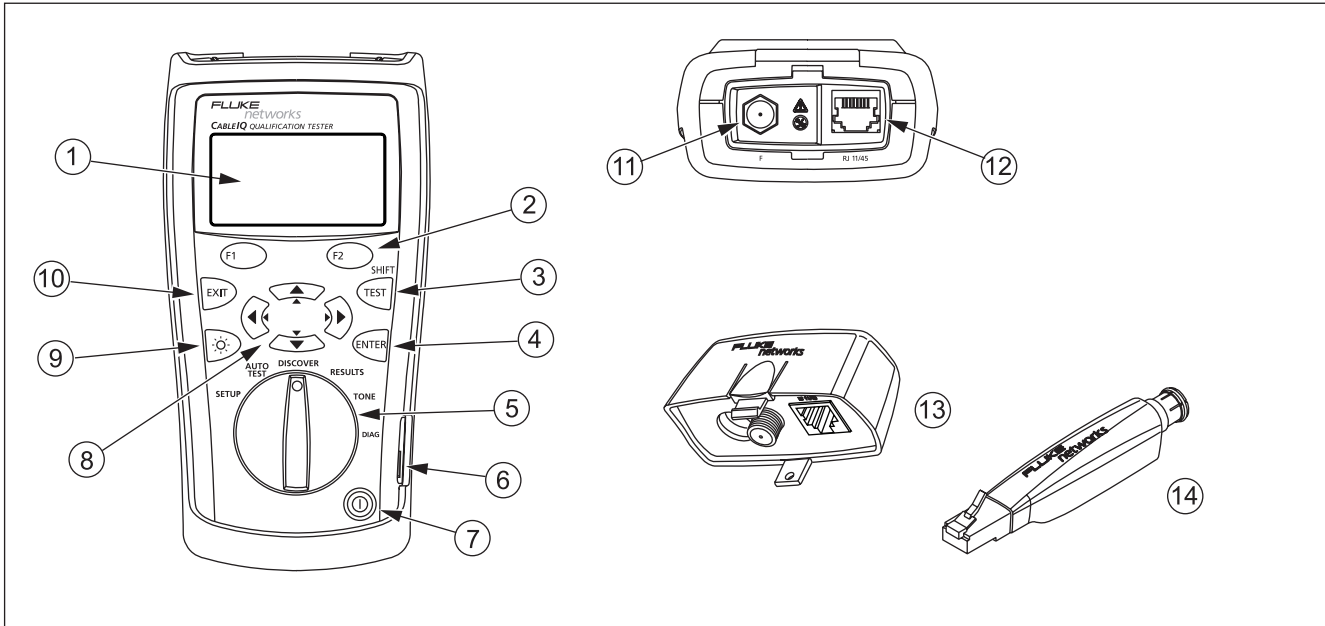

Figure 2. Features

avv01f.eps















- ① LCD display with backlight.
- ②  : The softkeys provide functions related to the current screen. The current functions are shown on the screen above the keys.
- ③ : Starts the currently selected test.
- ④ : Enter key selects the highlighted item from a menu. Enters and exits edit mode when making selections and editing text.
- ⑤ Rotary switch selects the tester's modes.
- ⑥ USB port for uploading test reports to a PC and updating the tester's software. See "Uploading Results to a PC" on page 62.
- ⑦ : On/off key.
- ⑧    : Arrow keys for navigating through screens and incrementing or decrementing alphanumeric values. For navigation, use   to page up and down. Use **SHIFT** and  or  to go to the top or bottom of a list.
- ⑨ : Toggles the backlight between dim and bright settings.
- ⑩ : Exits the current screen. Also exit edit mode when making selections and editing text.
- ⑪ F-connector for connecting to 75  $\Omega$  coaxial cable.
- ⑫ Modular jack for connecting to telephone and twisted pair network cable. The jack accepts 8-pin modular (RJ45) and 6-pin modular (RJ11) connectors.
- ⑬ Wiremap adapter with F-connector and modular jack. See "Using the Wiremap Adapter and Remote ID Locators" on page 10 for details.
- ⑭ Remote ID locator (optional) with F-connector and modular jack. See "Using the Wiremap Adapter and Remote ID Locators" on page 10 for details.

Figure 2. Features (cont.)

## Using the Wiremap Adapter and Remote ID Locators

Terminating the cabling under test with the standard wiremap adapter or optional remote ID locators provides the following advantages:

- **Full wiremap testing on twisted pair cabling**

Without an adapter or ID locator, the cabling cannot be qualified because the tester cannot detect all wiremap faults. Autotest results are provided for informational purposes only.

- **Easier identification of twisted pair and coaxial connections**

The adapter's number appears on the wiremap display. In Discover mode you can use multiple remote ID locators, each with a different number, to identify connections at patch panels.

The wiremap adapter and remote ID locators are functionally identical, except for their ID numbers. The wiremap adapter has an ID number of 1. The remote ID locators are available with other ID numbers.

To connect the remote ID locator to a modular (RJ) outlet in a confined area, use the optional universal adapter and a patch cord. See Figure 3.

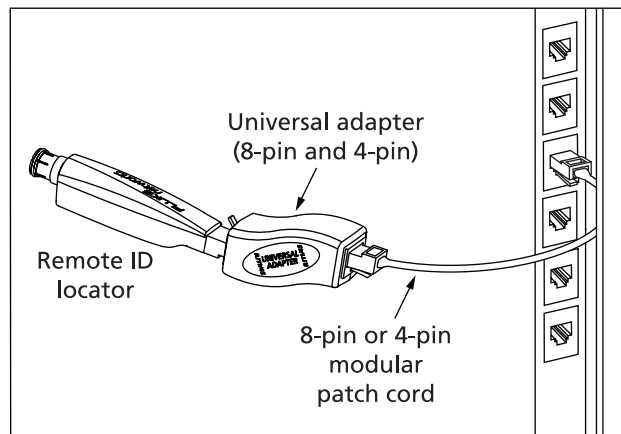

avv54f.eps

**Figure 3. Using the Universal Adapter for Confined Areas**

## Powering the Tester

You can power the tester with four AA alkaline batteries (included), four rechargeable nickel-metal hydride or nickel-cadmium batteries, or four 1.5 V lithium batteries.

Most of the tester's screens show a battery status icon () near the upper-left corner. The message **Low Batteries!** appears when the batteries are too low for the tester to function.

The batteries last about 20 hours during typical use (with the backlight at the dim setting).

Figure 26 on page 65 shows how to replace the batteries.

## Verifying Operation











The tester performs a basic self-test when you turn it on. If the tester reports an error or does not turn on, refer to "If Something Seems Wrong" on page 65.

## Setting User Preferences

The following sections describe settings you may want to change when you first start using the tester. For Autotest settings, see "Selecting Tests to Run" on page 18.

### Changing the Language and Length Units











To change the language and length units:

- 1 Turn the rotary switch to **SETUP**.
- 2 Press  to highlight **Language / m·ft**; then press  or .
- 3 Use   to highlight a setting; then press  or .
- 4 Use   to change the setting; then press .

## Setting the Time and Date

The time and date are stored with saved Autotests. The time setting uses a 24-hour clock.













To set the time and date:

- 1 Turn the rotary switch to **SETUP**.
- 2 Press  to highlight **Time / Date**; then press  or .
- 3 To select a field to edit, use   to highlight the field; then press  or .
- 4 Use   to change the setting in the selected field; then press .

## Entering User Information

The **User Information** screen lets you enter three lines of text that are stored with saved Autotest results. For example, you could enter the operator's name and your company's name and location.

To enter user information:

- 1 Turn the rotary switch to **SETUP**.
- 2 Use  to highlight **User Information**; then press  or .
- 3 Use   to highlight a box to edit; then press  or .
- 4 Use     and the softkeys to edit the text, as described in Figure 4.
- 5 Press  to save changes in the selected box.
- 6 Repeat steps 3 through 5 to edit text in other boxes.









<p style="text-align: right; font-size: small;">avv11f.eps</p>	<p>① The three fields for text entry.</p> <p>② Indicates the field is selected for editing. To select a field, use   to highlight the field; then press  or .</p> <p> : Moves the cursor. Moving the cursor beyond the last character inserts the first character from the last character's set.</p> <p> : Changes the highlighted character.</p> <p> <b>Ins</b>: Inserts the first character from the set that includes the highlighted character.</p> <p> <b>Del</b>: Deletes the highlighted character.</p> <p><b>SHIFT</b> and  or <b>SHIFT</b> and : Changes the character set.</p> <p>To save changes to a field, press .</p> <p>③ Indicates the text extends beyond the box. Use   to scroll.</p>
<b>Character Sets Available</b>	
<p>ABCDEFGHIJKLMNOPQRSTUVWXYZ  abcdefghijklmnopqrstuvwxyz  0123456789  #"!\$%&amp;'()*+,-./:;&lt;=&gt;?@[ \ ] ^ _ ` {   } space</p>	

Figure 4. Editing Text

### Auto Shutoff

You can set the tester to stay on indefinitely or turn off after 15 minutes of inactivity.









To set the auto shutoff:

- 1 Turn the rotary switch to **SETUP**.
- 2 Press  to highlight **Auto Shutoff**; then press  or .
- 3 Press  or , use   to select **15 Min** or **Never**; then press .

### Enabling or Disabling the Speaker

Turning off the speaker does not disable sounds for the continuity and toner functions.

To turn the speaker on or off:





- 1 Turn the rotary switch to **SETUP**.
- 2 Press  to highlight **Speaker**; then press  or .
- 3 Press  or , use   to select **On** or **Off**; then press .

### Resetting to Factory Settings

The **Factory Settings** function resets the following to factory settings:

- NVP settings
- Tests selected for the Autotest
- Wiremap pair selections for Autotests



To reset to factory settings:

- 1 Turn the rotary switch to **SETUP**.
- 2 Press  to highlight **Factory Settings**; then press  or .
- 3 Press  **Yes**.



## Checking the Hardware and Software Versions

You may need to check your tester's hardware or software versions before updating the software or if you contact Fluke Networks about the tester.

- 1 Turn the rotary switch to **SETUP**.
- 2 Press  to highlight **Version Information**; then press  or .

The **Version** screen shows the following:

- **SN:** Serial number
- **SW:** Software version
- **HW:** Hardware version
- **HW Date:** The date the tester's operation was last verified at a Fluke Networks service center.

## Qualifying Cabling with the Autotest

The Autotest tells you if cabling will support a selected application. If the cabling does not qualify for the application, the Autotest's fault information helps you diagnose the problem.

You can save Autotest results to document the installation.

The Autotest can qualify cabling for the following applications:

- 10BASE-T, 100BASE-TX, and 1000BASE-T twisted pair Ethernet service
- VoIP (voice over internet protocol)
- Firewire (1394b-S100) service over twisted pair cabling
- Analog telephone service
- Wiremap for any application
- 75  $\Omega$  coaxial applications, such as cable television

## CableIQ Qualification Tester

### Users Manual

---

Qualification differs from the certification done by testers such as the Fluke Networks DTX CableAnalyzer.

Certification involves testing against an industry standard and a test limit (Category 6 and TIA Cat 6 Permanent Link, for example). The cabling must perform within limits from 1 MHz to the highest frequency defined by standard.

Qualification means the cabling will support a selected application, such as 100BASE-TX Ethernet service. The Autotest qualifies cabling by testing the parameters

shown in Table 2 and comparing the results to the selected application's requirements.

If the Autotest fails, the results will help you diagnose the problem. See also "Diagnosing Cabling Faults" on page 73 for common causes of failures.

Table 2. Autotest Parameters

Test	Wiremap <sup>1</sup>	Length	Delay Skew	Signal Performance <sup>2</sup>
1000BASE-T	•	•	•	•
100BASE-TX	•	•		•
10BASE-T over twisted pair	•	•		•
VoIP	•	•		•
Wiremap	•	• <sup>3</sup>		
1394b S100 (Firewire)	•	•		•
Telco	•	• <sup>3</sup>		
Coax (75 Ω)	• <sup>4</sup>	• <sup>3</sup>		

1. Wiremap adapter or remote ID locator required for complete wiremap testing.
2. Crosstalk, insertion loss (attenuation), and return loss are tested. For 1000BASE-T, ELFEXT (equal-level far-end crosstalk) is also tested.
3. The test has no length limit, so the length test always passes.
4. Wiremap for coaxial cable is shield and conductor continuity.

## Selecting Tests to Run

To select tests to run during an Autotest:

Turn the rotary switch to **SETUP**; then select **Autotests**. Or  
turn the rotary switch to **AUTOTEST**; then press

**F1** **Setup**.

Figure 5 describes how to use the Autotest setup screens.

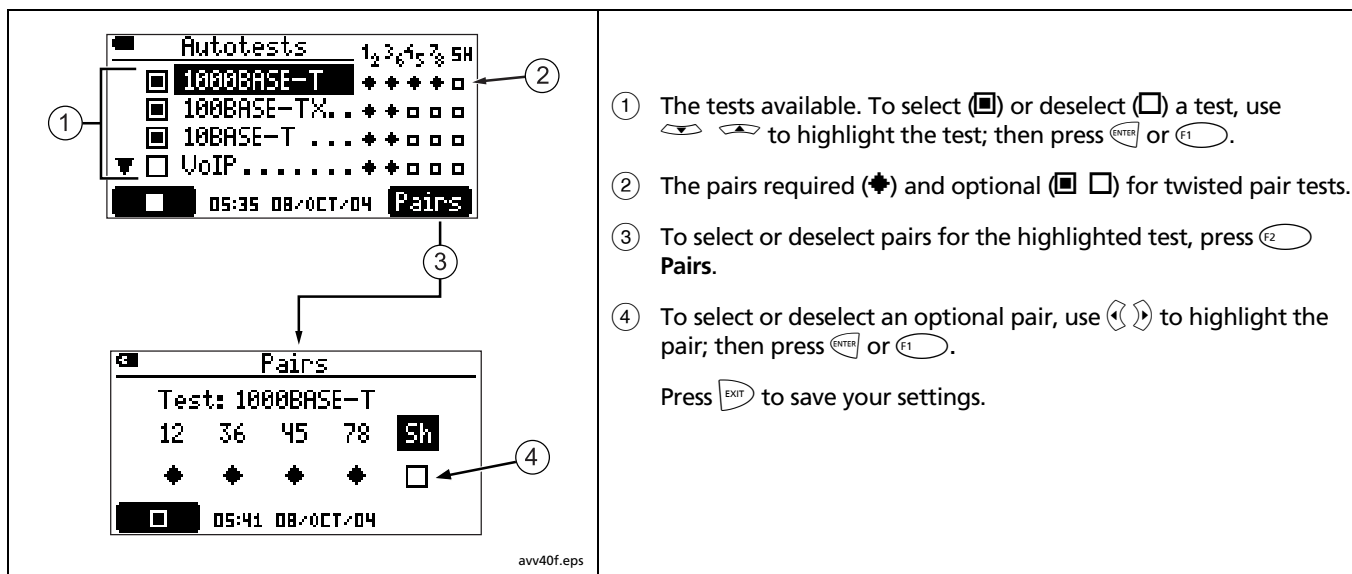

Figure 5. Autotest Setup Screens

## Autotest on Twisted Pair Cabling



### Notes

*A wiremap adapter or remote ID locator must be connected to the end of the cabling for the wiremap to be completely verified.*





*The Autotest does not support use of multiple remote ID locators (the MultiMap function).*







*If you use patch cords at the near or far end during an Autotest, Fluke Networks recommends patch cords at least 2 m long.*



*The Autotest will not run if the tester is connected to a data port, or detects voltage or a short on the cabling.*

- 1 Turn on the tester. Turn the rotary switch to **AUTOTEST**.
- 2 To change the tests to run,  or . See page 18.
- 3 Connect the tester and wiremap adapter or ID locator to the cabling. Figures 6, 7, and 8 show typical connections.
- 4 Press . The Autotest proceeds when a wiremap adapter or ID locator is detected. The analog toner turns on if neither is detected.

- 5 To save the test:

- a. Press  .
- b. Use   and  to select the **Site**, **Location**, or **Outlet** field for editing. You can enter up to 17 characters in each field. See Figure 4 on page 13 for details on editing text.

To see a list of predefined labels for the highlighted field, press  **List**. Use , , or **SHIFT** + ,  to move through the list. Use  or  to select an entry.

- c. On the **Enter ID** screen, press   to save the results with the **Site**, **Location**, and **Outlet** entries shown.

### Note

*The last character of the **Outlet** string increments each time you save an Autotest.*

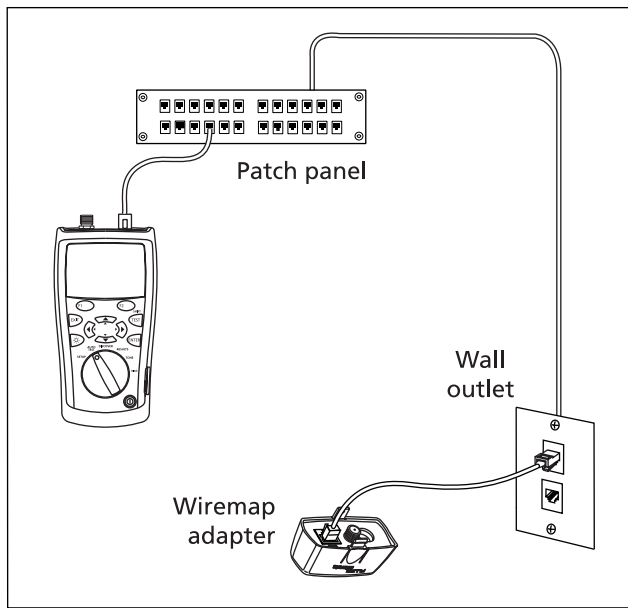

**Figure 6. Autotest Connections for Twisted Pair Network Cabling**

### Connecting to Star Topologies

Telephone cables wired in a star topology (Figure 7) are connected together at a bridge tap at the distribution center. The bridge tap connects each wire to all other wires of the same number.

The tester detects bridge taps and measures the distance to the bridge tap. To measure the length of each cable connected to the bridge tap, you must connect the wiremap adapter or remote ID locator to the bridge tap and the tester to the wall outlet. The tester cannot measure length past the bridge tap because reflections from the bridge tap connections interfere with measurements.

If you connect the tester to the bridge tap, the tester measures the length only to the bridge tap, which is only the patch cord length.

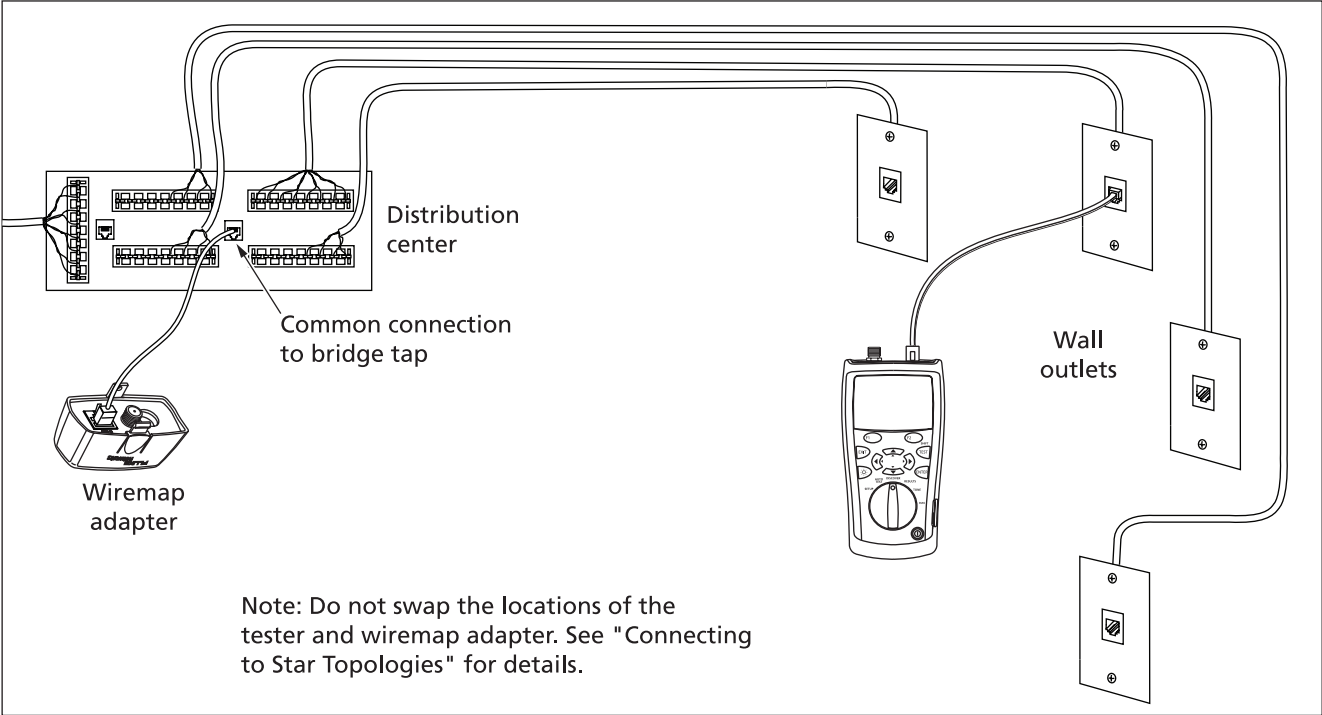

Figure 7. Autotest Connections for Telephone Cabling in a Star Topology

avv12f.eps

### Connecting to Bus Topologies

Telephone cables wired in a bus topology (Figure 8) connect the wall outlets in series. In this topology, you measure the length from the last outlet to the distribution center.

If you connect to an outlet in the middle of the series, the tester reports a bridge tap. The length reported is the length to the outlet, which is the patch cord length. The tester cannot measure length past the outlet because reflections from the cables on either side interfere with measurements.

**Tip:** To quickly verify the wiremaps of telephone cabling connected to a bridge tap, use the MultiMap function in **DISCOVER** mode. See page 46.

If you are unsure which outlet is the last in the bus, do the following:

- 1 Connect the wiremap adapter or ID locator to the beginning of the bus at the distribution center.
- 2 Connect the tester to an outlet. Turn the rotary switch to **DISCOVER**.
- 3 If the tester reports a bridge tap, move to another outlet. The last outlet will not show a bridge tap, and will show the length to the distribution center.

### About Qualification for VoIP (Voice Over Internet Protocol)

Cabling that qualifies for VoIP will support the voice over IP application; however, the quality of service may vary depending on other factors. These factors include the quality of the transmission system between the far-end VoIP device and your cabling, the equipment used, and the equipment's QoS (quality of service) settings and performance.



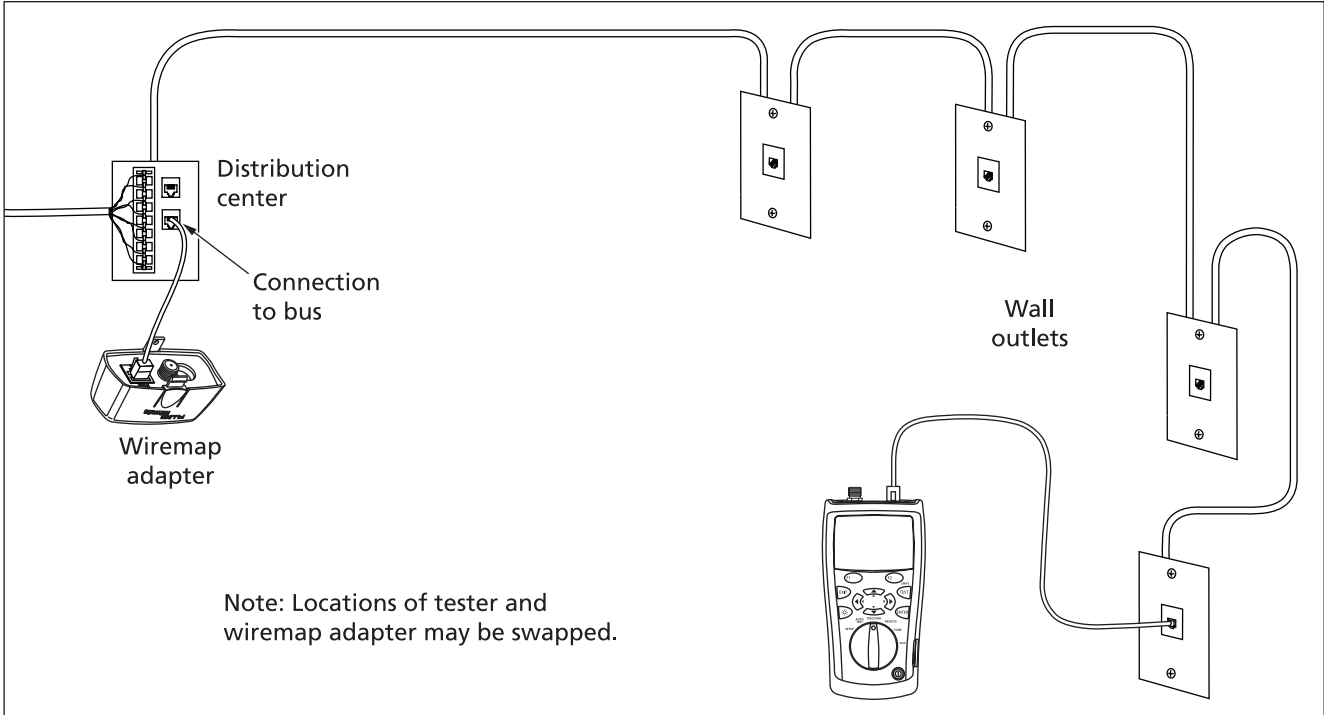

Figure 8. Autotest Connections for Telephone Cabling in a Bus Topology

avv13f.eps

## Autotest Results for Twisted Pair Cabling

The Autotest shows results in three levels of detail, as described in Figures 9 through 12.

① Overall result for the Autotest.

② Overall result for each Autotest type:

- ✓: The cabling qualifies for the application. If a far-end adapter is not connected, the tester assigns a **i** result because the wiremap cannot be completely verified.
- ✗: The cabling does not qualify for the application.
- i**: Results are for informational purposes only, not for qualification. The cabling cannot be completely qualified for the application because the wiremap results are incomplete (wiremap adapter not used).

Use to scroll through the tests.

③ Press **F1** or **ENTER** to see summary results for the highlighted test. To see details for a test parameter, use to highlight the parameter; then press **F1** or **ENTER**.

④ Press **F2** to save the results.

avv15f.eps

Figure 9. Autotest Summary Screens

Wiremap Results

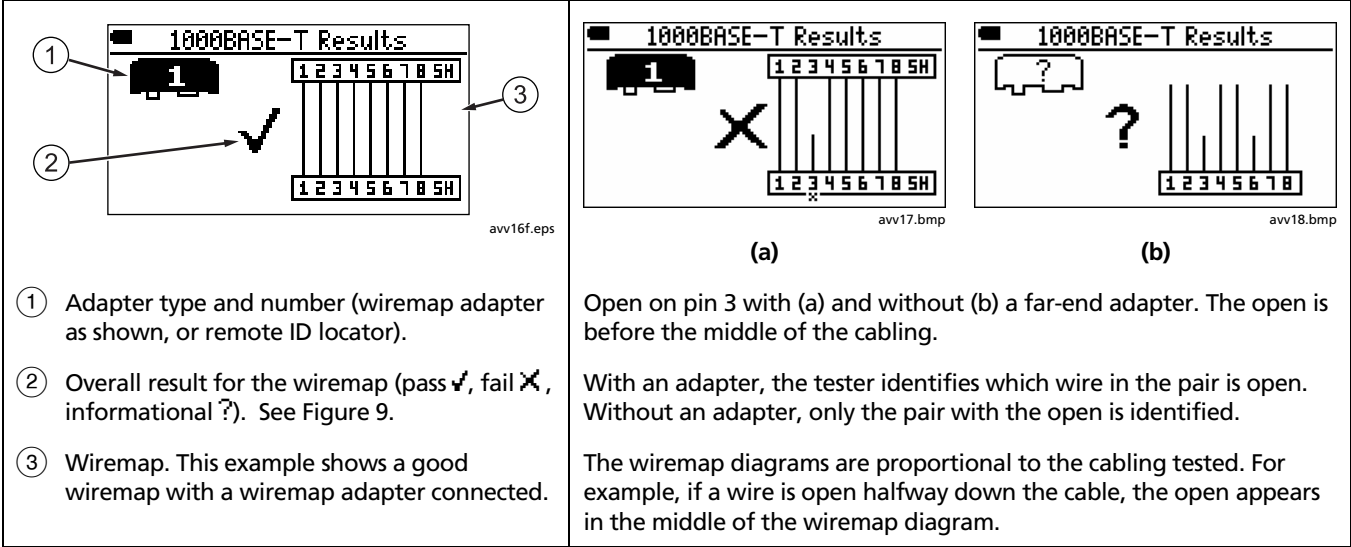

-continued-

Figure 10. Typical Wiremap Screens

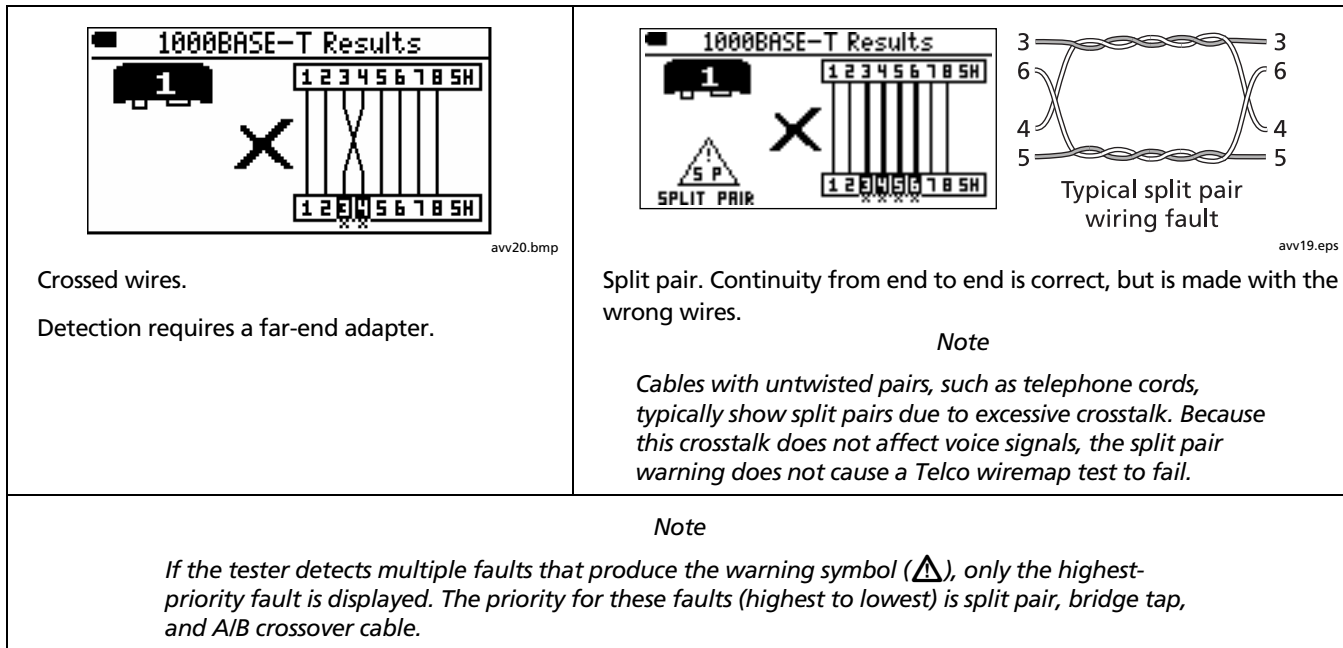

-continued-

Figure 10. Typical Wiremap Screens (cont.)

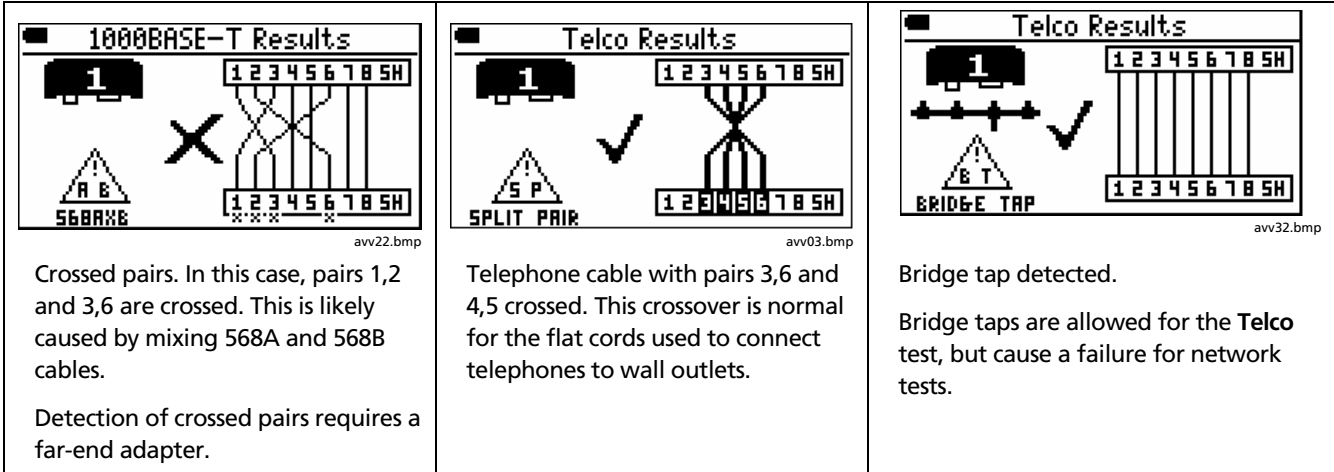

Crossed pairs. In this case, pairs 1,2 and 3,6 are crossed. This is likely caused by mixing 568A and 568B cables.

Detection of crossed pairs requires a far-end adapter.

Telephone cable with pairs 3,6 and 4,5 crossed. This crossover is normal for the flat cords used to connect telephones to wall outlets.

Bridge tap detected.

Bridge taps are allowed for the **Telco** test, but cause a failure for network tests.

Figure 10. Typical Wiremap Screens (cont.)

## Signal Performance Results

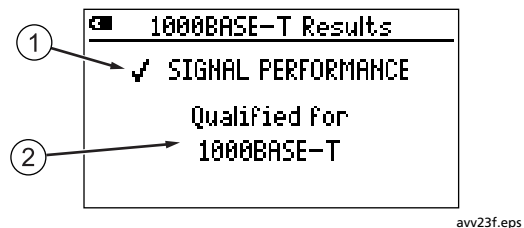

### Note

*Signal performance results for cables less than 13 ft (4 m) long may be unreliable.*

- ① Qualified/unqualified result for the signal performance. Signal performance includes crosstalk, insertion loss, and return loss. For 1000BASE-T, ELFEXT (equal-level far-end crosstalk) is also tested.

- ② Information about the signal performance:

- **Qualified for <application name>:** The cabling will support the application.
- **No Signal Performance tests needed for qualification:** Appears for the **Telco** and **Wiremap only** tests.
- **Wiring fault! Not tested.:** The tester does not evaluate signal performance if there is a wiremap, length, or delay skew fault.
- **Connection fault:** A localized crosstalk fault was detected. Localized faults are usually caused by bad connections. Check the cabling at the location given. See the Appendix for other causes of crosstalk faults.
- **Distributed cable faults:** Crosstalk or an impedance problem was detected along most or all of the cabling. The cabling is of poor quality or is the wrong category for the selected application.

-continued-

Figure 11. Signal Performance Results

**Tip:** To determine if a fault is caused by a crosstalk or impedance problem, use the **Find Crosstalk Fault** and **Find Impedance Fault** functions in Diagnostic (**DIAG**) mode.

- **Fault detected:** A localized impedance fault was detected. Localized faults are usually caused by bad connections. Check the cabling at the location given. See the Appendix for other causes of impedance faults.
- **Fault at connection to tester:** The plug connected to the tester is bad, or the tester's connector is damaged.
- **Insertion loss fault:** The cabling's attenuation is too high. See the Appendix for causes of insertion loss problems.
- **1000BASE-T bandwidth fault:** The cable has high ELFEXT (equal-level far-end crosstalk). This may be caused by poor-quality cable or connecting hardware. See the Appendix for other causes of ELFEXT faults.

Figure 11. Signal Performance Results (cont.)

## Length Results

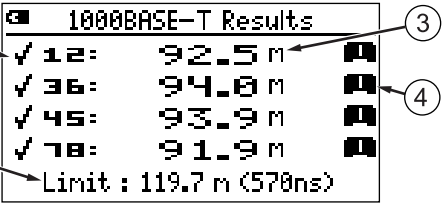

The screenshot shows the following data:

Pair	Length (m)	Termination
✓ 12	92.5	Wiremap adapter or remote ID locator
✓ 36	94.8	Wiremap adapter or remote ID locator
✓ 45	93.9	Wiremap adapter or remote ID locator
✓ 78	91.9	Wiremap adapter or remote ID locator

Limit : 119.7 m (570ns)

avv24f.eps

① Qualified/unqualified result, which is given only for pairs required by the application or selected in the Autotest settings.

② Length and signal delay limits. Delay is given in nanoseconds (ns). One nanosecond is 0.000000001 second.

③ Length of the pair.

*Note*  
A 2 % to 5 % difference in measured lengths among twisted pairs is typical. This is due to differences in the number of twists in the pairs.

④ Termination for the pair:

- : Wiremap adapter or remote ID locator, with its number.
- : Open
- : Bridge tap.
- : The tester cannot identify the termination.

-continued-

Figure 12. Length Result Screens



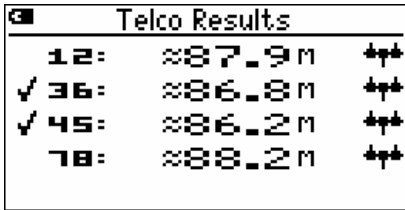

Telco Results		
12:	≈87.9 m	***
✓ 36:	≈86.8 m	***
✓ 45:	≈86.2 m	***
78:	≈88.2 m	***

avv27.bmp

Bridge tap detected at about 86 m.

The distance to a bridge tap is approximate (≈) because multiple reflections from the bridge tap interfere with length measurements.

*Note*

*Bridge tap detection requires a minimum of two branches (excluding the branch connected to the tester) at least 15 ft (4.6 m) long each, with a combined length of at least 40 ft (12.2 m).*

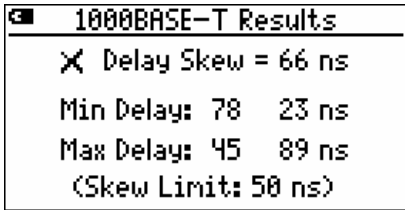

1000BASE-T Results	
✗	Delay Skew = 66 ns
Min Delays:	78 23 ns
Max Delays:	45 89 ns
(Skew Limit: 50 ns)	

avv33.bmp

Delay skew failure (1000BASE-T only). Delay skew results are available only if delay skew failed.







Delay skew is the difference in the arrival times of signals on the cable pairs. See the Appendix for causes of delay skew problems.

*Note*





*If both the length test and skew test failed, only the length results are shown.*









Figure 12. Length Results Screens (cont.)



## Autotest on Coaxial Cabling (75 Ω)

- 1 Turn on the tester and turn the rotary switch to **AUTOTEST**.
- 2 Press  . If the coax test is disabled, press  or  **Setup** to enable it.
- 3 Connect the tester and wiremap adapter or ID locator to the cabling as shown in Figure 13.
- 4 Press . The Autotest proceeds when a wiremap adapter or ID locator is detected. The analog toner turns on if neither is detected.
- 5 To view results, press  . See Figure 14.

- 6 To save the results:

- a. Press  .
- b. Use   and  to select the **Site**, **Location**, or **Outlet** field for editing. You can enter up to 17 characters in each field. See Figure 4 on page 13 for details on editing text.

To see a list of predefined labels for the highlighted field, press  **List**. Use , , , , or **SHIFT** +   to move through the list. Use  or  to select an entry.

- c. On the **Enter ID** screen, press   to save the results with the **Site**, **Location**, and **Outlet** entries shown.

### Note

*The last character of the **Outlet** string increments each time you save an Autotest.*

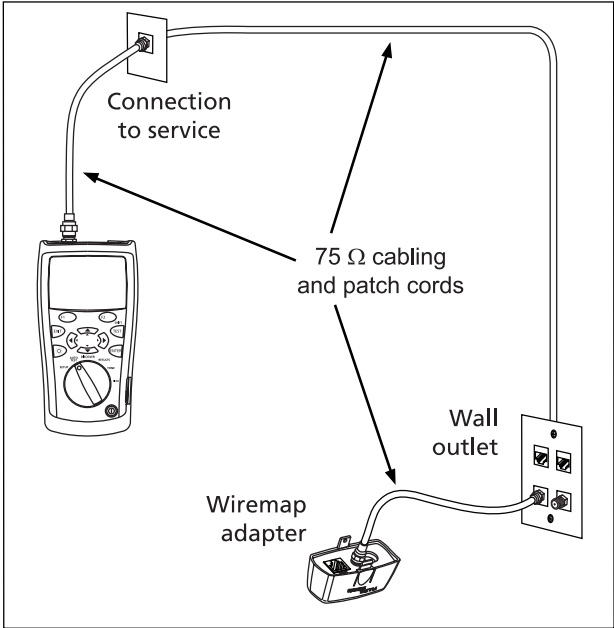

avv34f.eps

Figure 13. Autotest Connections for Coaxial Cabling

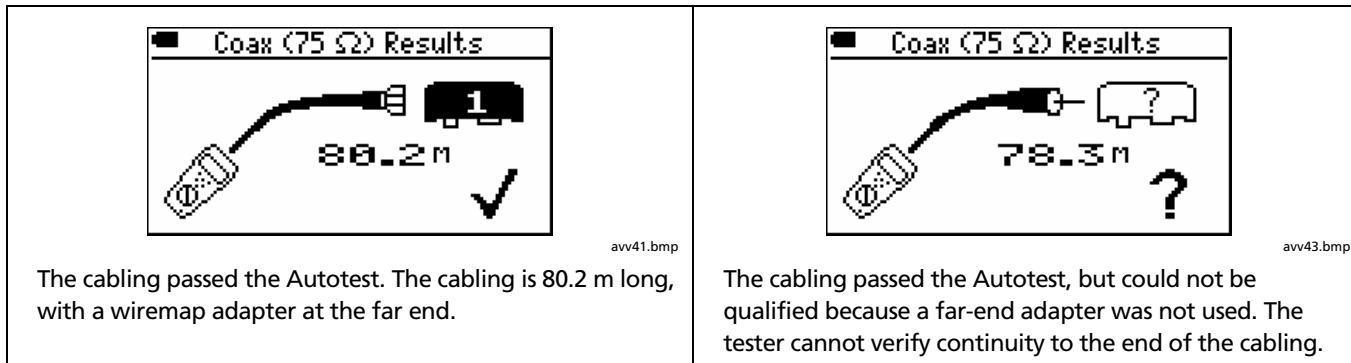

-continued-

Figure 14. Autotest Results for Coaxial Cabling

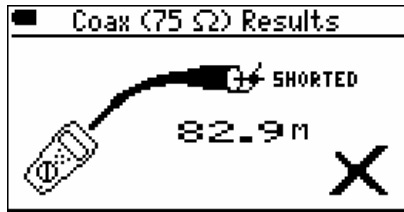

avv42.bmp

The cabling failed the Autotest because it is shorted. The short is at 82.9 m in this example.

*Note*

*Devices with low input resistance may be reported as a short.*

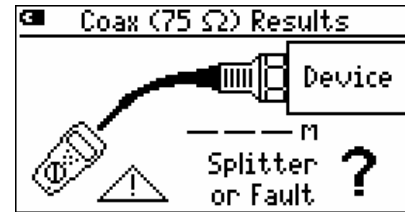

avv45.bmp

There is a splitter or fault somewhere along the cabling. Faults that typically cause this message are impedance faults, such as a section of cable with the wrong impedance.

If there is a splitter between the tester and wiremap adapter, the tester cannot verify continuity to the adapter, and may indicate that a device is connected.

Length cannot be determined because the splitter or fault interferes with reflections used for length measurements.

**Tip:** Use the TDR plot in Discover mode to locate impedance problems on coaxial cabling. See page 44.

The **Splitter or Fault** message may also appear on the other coaxial screens described in this section.

-continued-

**Figure 14. Autotest Results for Coaxial Cabling (cont.)**

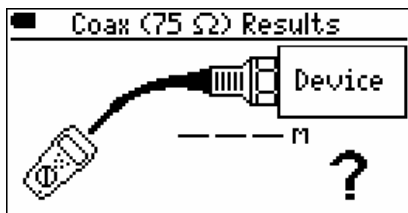

avv44.bmp

The cabling is connected to a device, such as a television, CATV service, VCR, DVD player, satellite dish, or antenna. The device is turned off or its signal is outside the tester's detection band (40 MHz to 150 MHz).

The cabling cannot be qualified because length cannot be determined. The device interferes with reflections used for length measurements.

Some splitters may also appear as devices.

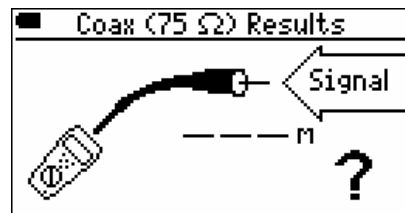

avv01.bmp

The cabling is connected to an active signal source that is within the tester's detection band (40 MHz to 150 MHz), such as a television, CATV service, VCR, DVD player, satellite dish, or antenna.

The cabling cannot be qualified because length cannot be determined. The device interferes with reflections used for length measurements.

Figure 14. Autotest Results for Coaxial Cabling (cont.)

## Discovering Cabling Characteristics

Discover mode lets you quickly check wiremaps, measure length, and determine if the cabling is connected to a network or video device. Discover mode runs continuously to help you isolate intermittent connections.

Discover mode tells you about the following:

### For twisted pair cabling

- Wiremap
- Length
- Speed of an attached port (such as a hub or a network interface card in a PC)
- Connection to telephone service

### For 75 $\Omega$ coaxial cabling

- Continuity
- Length
- Indicates signal presence or connection to a device (such as CATV service, VCR, DVD player, satellite dish, or antenna)

- TDR (time domain reflectometry) plot. This shows impedance changes along the cabling.

Results from Discover mode cannot be saved.

To test cabling in Discover mode:

#### Note

*Not connecting a wiremap adapter or remote ID locator to the far end of twisted pair cabling limits the types of wiremap faults the tester can detect.*

- 1 Connect the tester to the cabling. Figures 6, 7, 8, and 13 on pages 20, 21, 23, and 33 show typical connections using a wiremap adapter.

You may also connect to cabling connected to network or video devices.

- 2 Turn the rotary switch to **DISCOVER**.

## Discover Mode Results for Twisted Pair Cabling

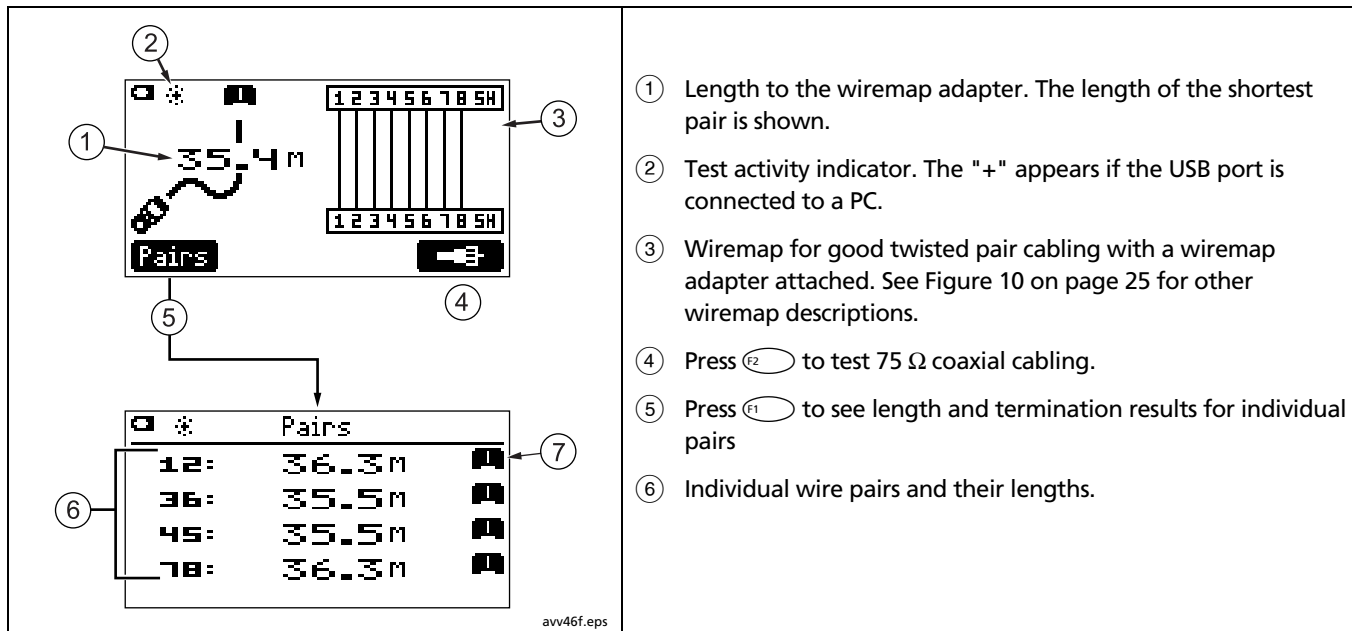

Figure 15. Discover Mode Results for Twisted Pair Cabling

-continued-



⑦ Termination for the pair:

- : Wiremap adapter or remote ID locator, with its number.
- : Open
- : Short
- : Port, such as a hub, switch, or PC.
- : Bridge tap.
- : Voltage is detected. This may indicate an active telephone circuit, ISDN line, or Power over Ethernet (PoE) device. See page 6.
- : The tester is connected to an active telephone circuit.
- : A signal is present on the pair.
- : The tester cannot identify the termination.

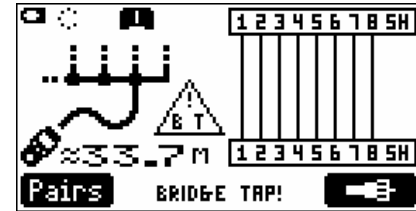

avv49.bmp

Bridge tap detected at about 33.7 m.

The distance to a bridge tap is approximate (≈) because multiple reflections from the bridge tap interfere with length measurements.

*Note*

*Bridge tap detection requires a minimum of two branches (excluding the branch connected to the tester) at least 15 ft (4.6 m) long each, with a combined length of at least 40 ft (12.2 m).*

-continued-

Figure 15. Discover Mode Results for Twisted Pair Cabling (cont.)

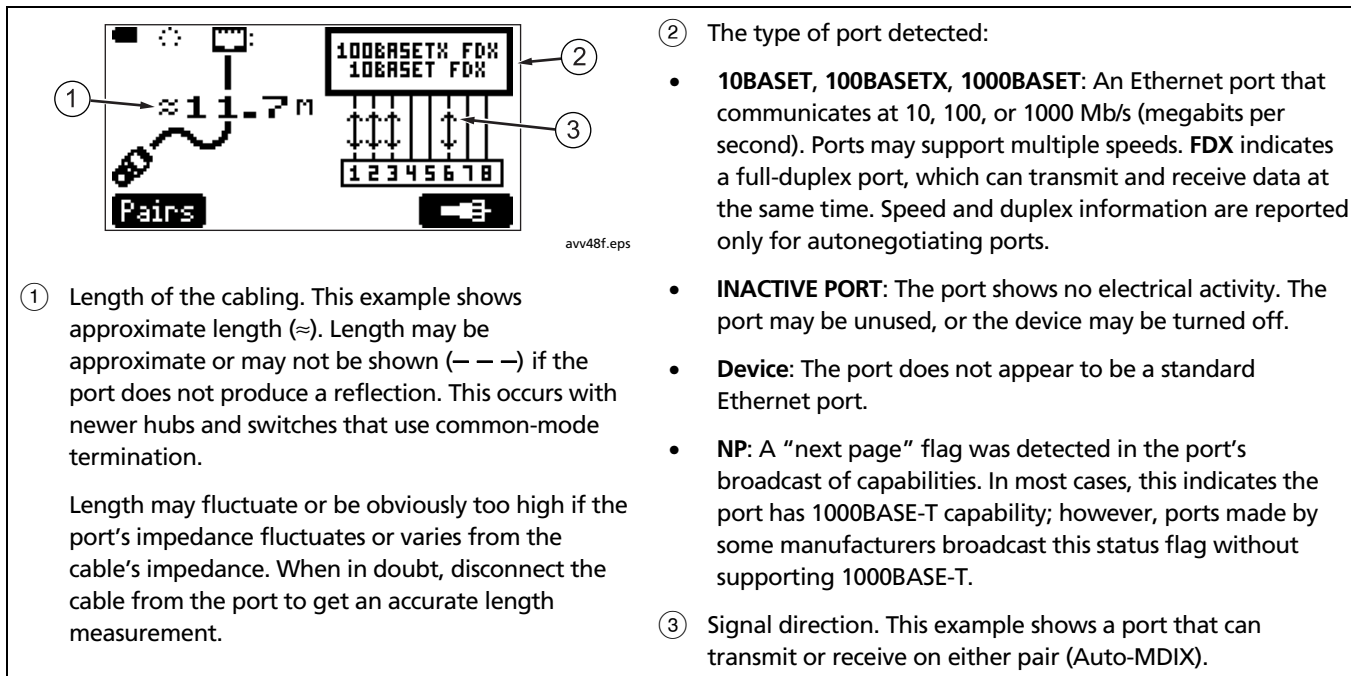

-continued-

Figure 15. Discover Mode Results for Twisted Pair Cabling (cont.)

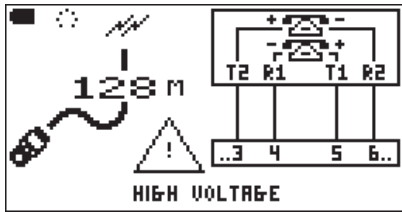

avv02.bmp

The tester is connected to an active telephone circuit. R1, T1, R2, and T2 show connections for lines 1 and 2. For active digital lines, the length shown may fluctuate or may not be shown (— —) because of varying termination on the line. See page 6.

**⚠ Warning ⚠**

The tester is not intended to be connected to active telephone inputs, systems, or equipment, including ISDN devices. Exposure to the voltages applied by these interfaces may damage the tester and create a potential shock hazard for the user.



avv60.bmp

Short between pins 1 and 2. Cable length is 92 m. Shorts are shown near the bottom of the wire map regardless of their location on the cabling.

Figure 15. Discover Mode Results for Twisted Pair Cabling (cont.)

## Discover Mode Results for Coaxial Cabling

To see results for coaxial cabling in Discover mode, press **F2** . Figure 16 describes some typical coaxial results screens.

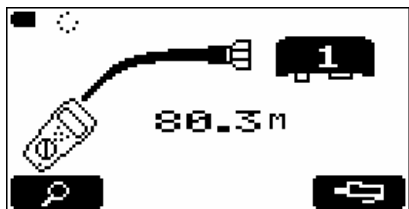

avv50.bmp

Coaxial cabling with wiremap adapter attached. The cabling is 80.3 m long.

Press **F1**  to see a TDR plot of the cabling. See Figure 17.

Figure 14 on page 34 describes additional coaxial results.



avv55.bmp

Cabling is open at the far end.

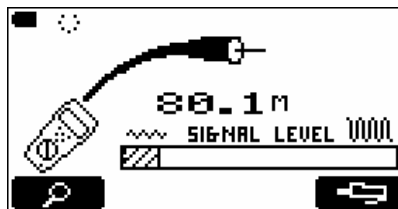
The signal level graph appears when no wiremap adapter or ID locator is connected. No signal is present in this example.

-continued-

Figure 16. Discover Mode Results for Coaxial Cabling

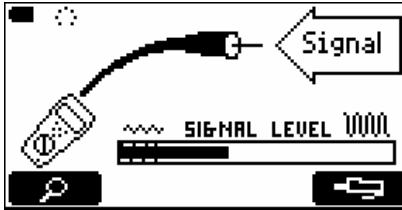

avv35.bmp

Cabling is connected to a device at the far end, such as a television, CATV service, VCR, DVD player, satellite dish, or antenna.

The signal level graph indicates the strength of the signal. Passive (non-amplifying) devices, such as satellite dishes and antennas, usually produce low-level signals in the cross-hatched area at the left side of the graph. Active devices, such as CATV service or a DVD player, produce levels beyond the cross-hatched area. The example above shows a VCR's signal level.

**Figure 16. Discover Mode Results for Coaxial Cabling (cont.)**

## TDR Plot for Coaxial Cabling

Discover mode includes a TDR (time domain reflectometry) plot. TDR is like radar. The tester sends a pulse down the cable, and receives reflections from impedance changes along the cable. The tester then plots the reflections on a distance scale to show you

where impedance changes occur. Signal reflections are undesirable because they can cause poor CATV reception.

The Appendix lists some causes of impedance changes.

Figure 17 shows examples of TDR plots with some of these faults.

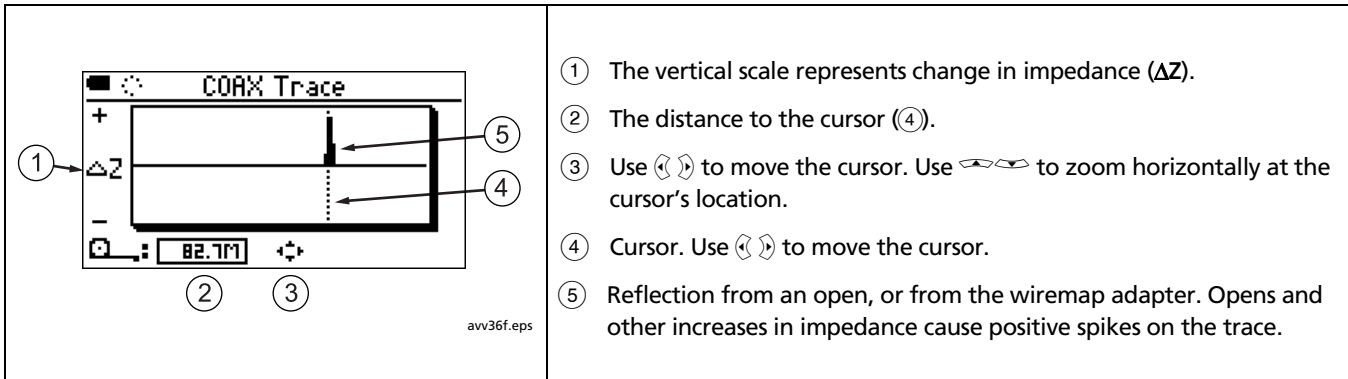

-continued-

Figure 17. TDR Plots for Coaxial Cabling

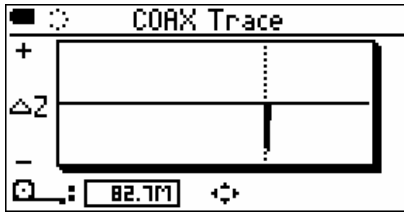

avv51.bmp

Reflection from a short.

Shorts and other decreases in impedance cause negative spikes on the trace.

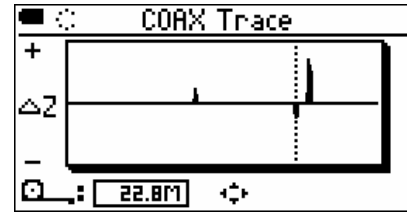

avv52.bmp

Reflection from a section of cable with the wrong impedance (followed by the end of the cable).

The small positive spike at the start of the section indicates higher impedance than the rest of the cable. The negative spike is the end of the section, where the impedance drops to the correct value.

Figure 17. TDR Plots for Coaxial Cabling (cont.)

## Using Multiple Remote ID Locators in Discover Mode (MultiMap™)

In Discover mode you can use multiple remote ID locators to quickly verify the wiremaps of multiple telephone cables connected in a star or bus topology. When you connect the tester at the distribution center, the MultiMap screen shows all of the wiremaps (Figure 18).

Figure 19 shows how to connect the tester and remote ID locators for the MultiMap function.

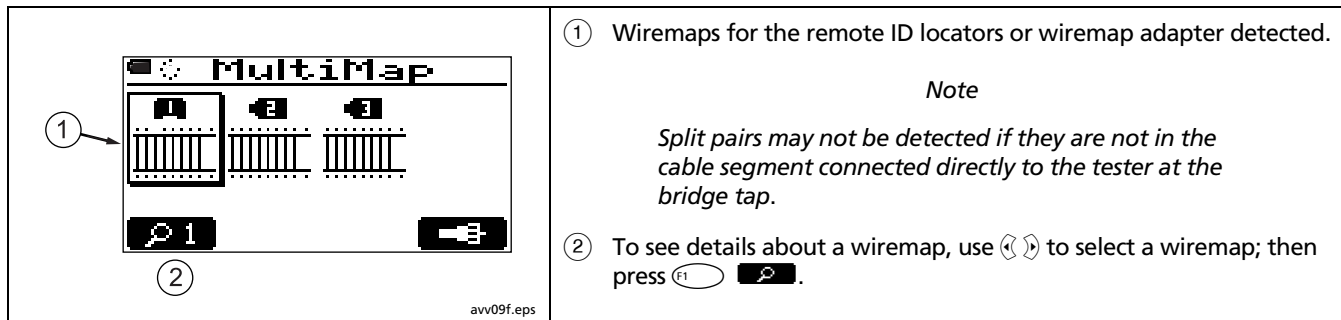

Figure 18. MultiMap Results



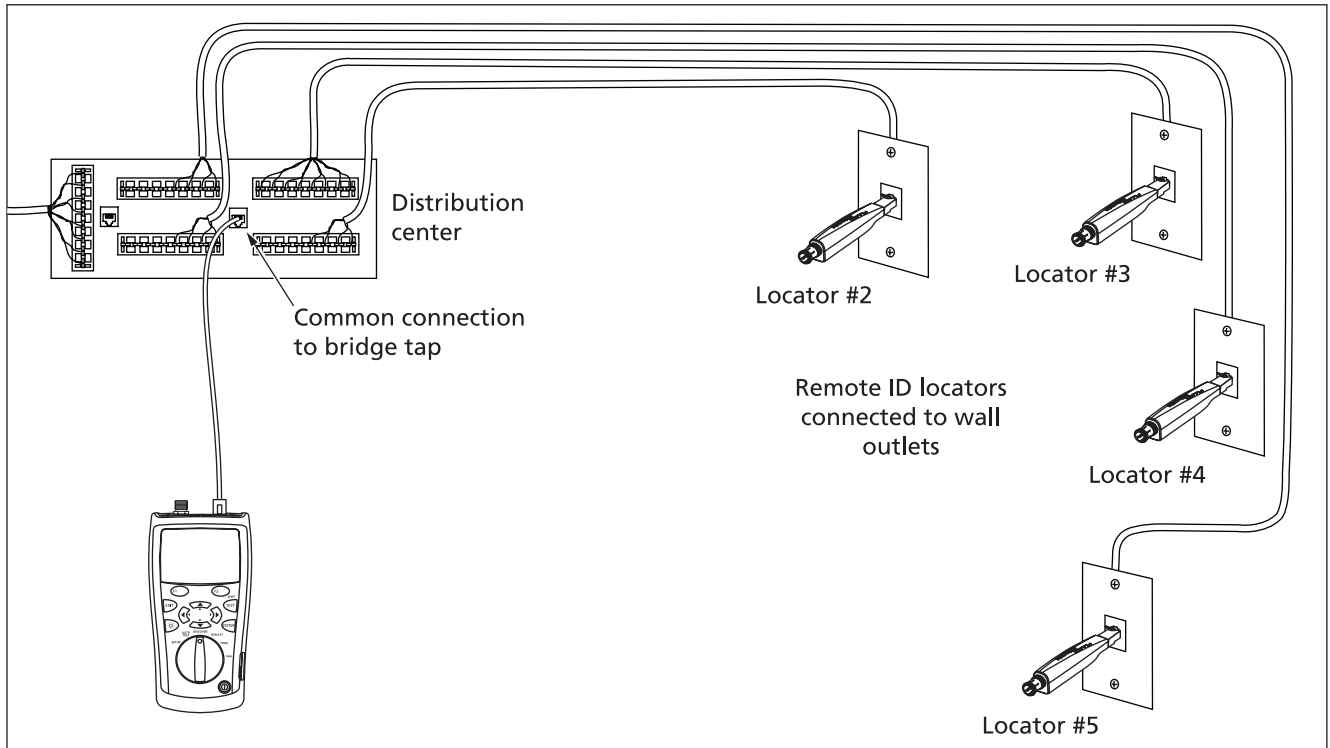

Figure 19. Using Multiple Remote ID Locators

avv07f.eps

### Using the Toner

You can use the tester with an optional tone probe to locate cables in bundles, at patch panels, or behind walls.

Use the tester's IntelliTone™ functions with a Fluke Networks IP100 or IP200 tone probe. The digital IntelliTone signal is easier to detect at a distance than analog tones, and its frequency and encoding eliminate cable misidentification due to signal bleed and radiated or ambient noise.

The tester's other tones, which are analog, can be detected by most tone probes.



To use the toner:

- 1 Connect the tester to twisted pair or coaxial cabling as shown in Figure 20.
- 2 Turn the rotary switch to **TONE**.

- 3 Use  to highlight a tone:

**IntelliTone:** One-note and two-note IntelliTone signals for use with a Fluke Networks IP100 or IP200 probe.

**Tone 1, Tone 2, Tone 3, Tone 4:** Multi-note, analog tones detectable by most tone probes.

For tones 1 through 4, press   to hear the tones.

- 4 To tone coaxial cable, press  .

- 5 Use the probe to search for the cable.

For details on using the IntelliTone function, see the tone probe's documentation.

The toner also turns on when you start an Autotest with no adapter or ID locator connected.

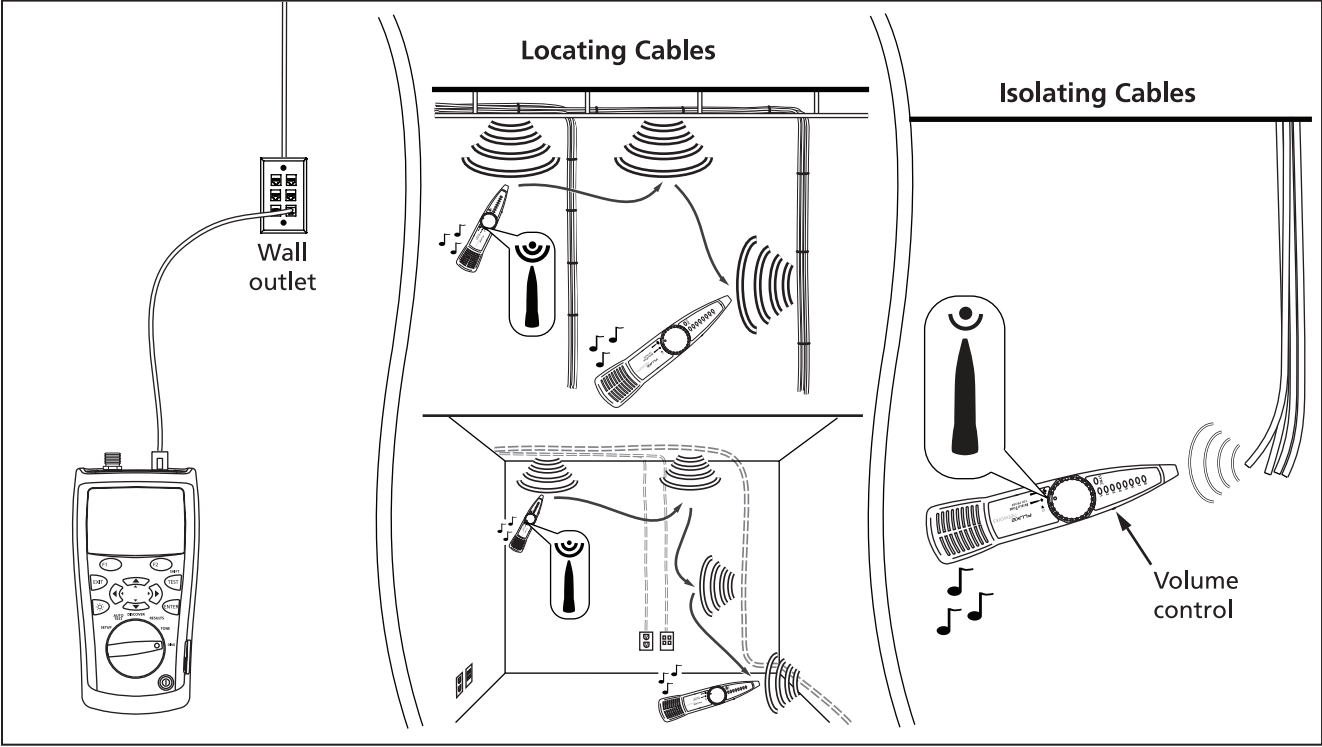



Figure 20. Using the Toner (twisted pair example with IntelliTone probe)

avv06f.eps

## Using the IntelliTone Cable Map Function

The tester's IntelliTone functions also work with an IP200 probe's cable map function to verify wiring.

To use the toner and an IP200 IntelliTone probe's cable map function:

- 1 Connect the tester and probe to twisted pair cabling as shown in Figure 21.
- 2 Turn the tester's rotary switch to **TONE**.
- 3 Use  to highlight the one-note or two-note IntelliTone selection.
- 4 The probe's LEDs light in sequence to indicate the cable's wiring. See the probe's documentation for details.

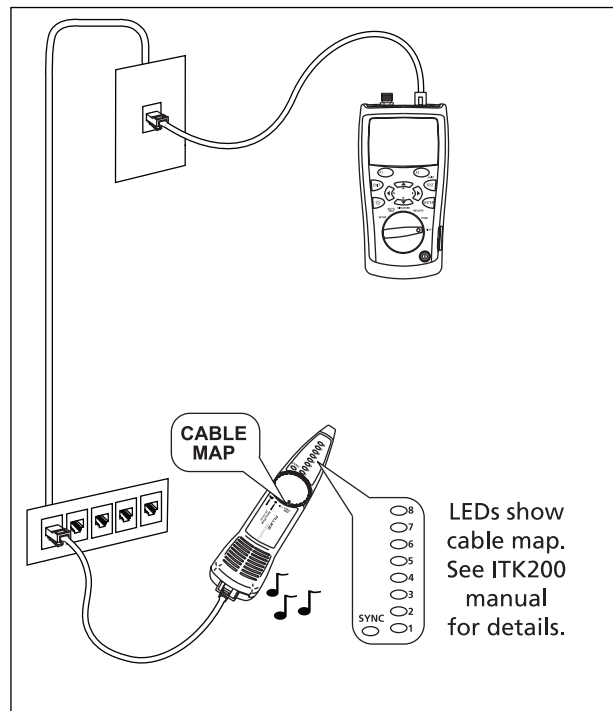





Figure 21. Using the Toner with the IP200 IntelliTone Cable Map Function

## Blinking a Port Light

The **Blink Port Light** function helps you determine which cable is connected to which port on a network hub or switch. This function generates a link pulse on pairs 12 and 36 to blink the port's activity LED.

The tester's analog toner is also active when the port light function is active.

To blink a port light:

- 1 Turn the rotary switch to **DIAG**.
- 2 Connect the tester to the cabling as shown in Figure 22.
- 3 Use  to highlight **Blink Port Light**; then press , , or .

To change the blink rate, press .

- 4 Check the hub or switch to see which activity LED is blinking. The tester's analog toner is on, so you can also use a tone probe to locate the cable if necessary.

### Note

*The **Blink Port Light** function does not work with non-negotiating hubs or with ports that use signal timing outside of typical timing parameters.*

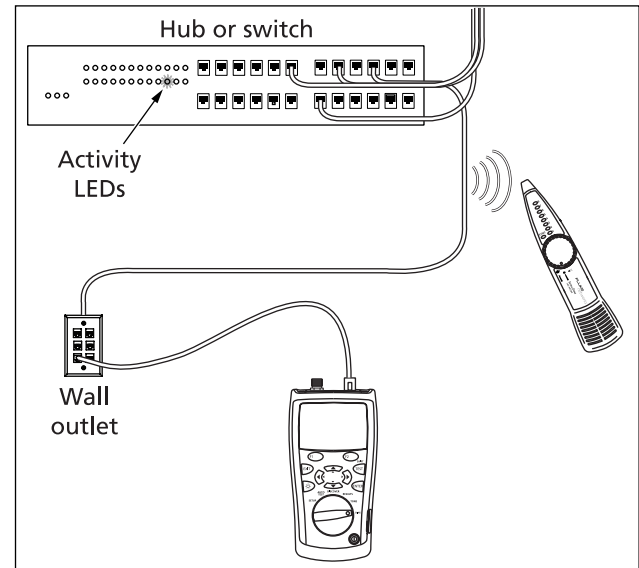

Figure 22. Blinking a Port Light







avv05f.eps

## Testing for Continuity

The continuity function lets you test for opens and shorts on the 8-pin modular jack or the coaxial connector. The tester shows a bar graph of resistance from 500  $\Omega$  to 5000  $\Omega$ , and the tester's audible tones vary depending on the resistance measured.

On an 8-pin jack, the tester checks for continuity between the wires in the pair you select. Pair 12 is the default.

To check continuity:

- 1 Verify that the circuit to be tested is not powered or in service. For cabling, use **DISCOVER** mode to check for active services. For other types of circuits or components, use a voltage meter to check for power.
- 2 Turn the rotary switch to **DIAG**.
- 3 Use  to highlight **Continuity**; then press , , or .
- 4 To check continuity using the coaxial connector, press  .
- 5 Connect the tester to the circuit, component, or cabling to be tested. Figure 23 shows connections using the optional 8-clip test lead.

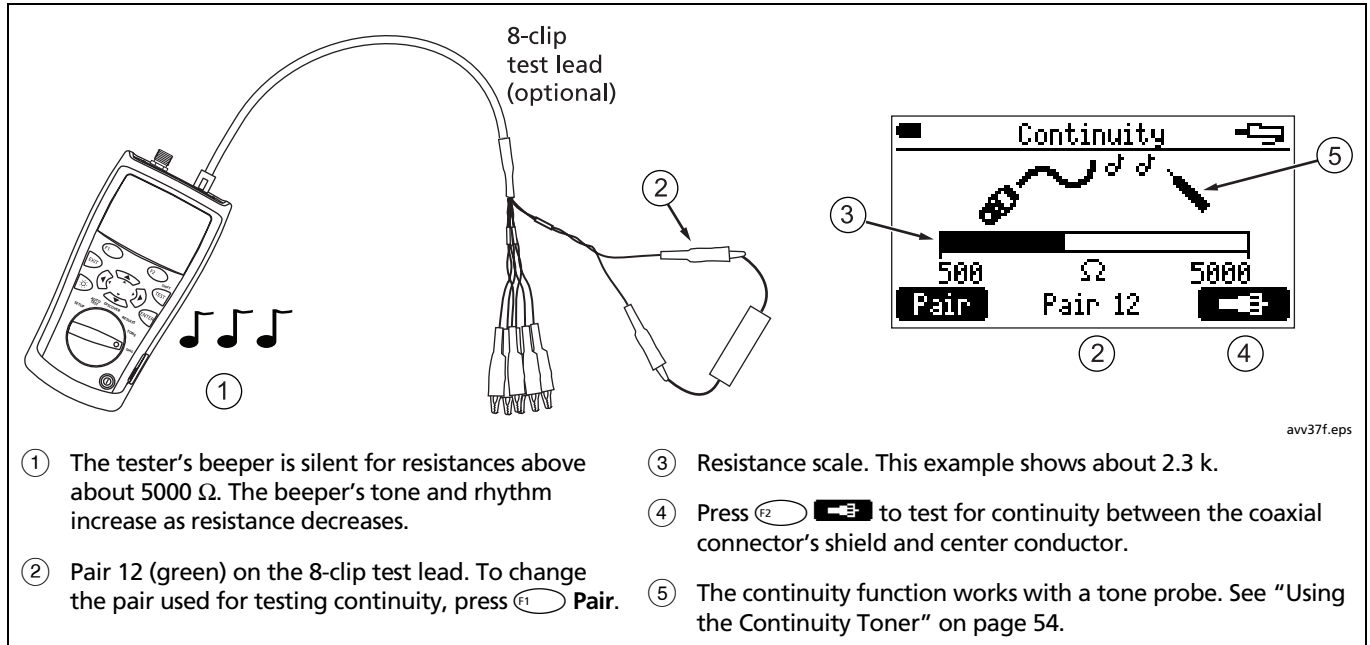

avv37f.eps

Figure 23. Testing for Continuity

## Using the Continuity Toner

The continuity function also acts as a toner for use with an optional tone probe. The signal's tone and rhythm increase as resistance decreases. This lets you use a tone probe to detect changes in resistance between wires in a cable.

The tester's continuity beeper is silent above 5 k $\Omega$ , but the toner signal is present for all resistance values.

Figure 24 shows a typical application for the continuity toner: testing security switches.

To use the continuity toner, refer to Figure 24 and use the continuity function as described on page 52.



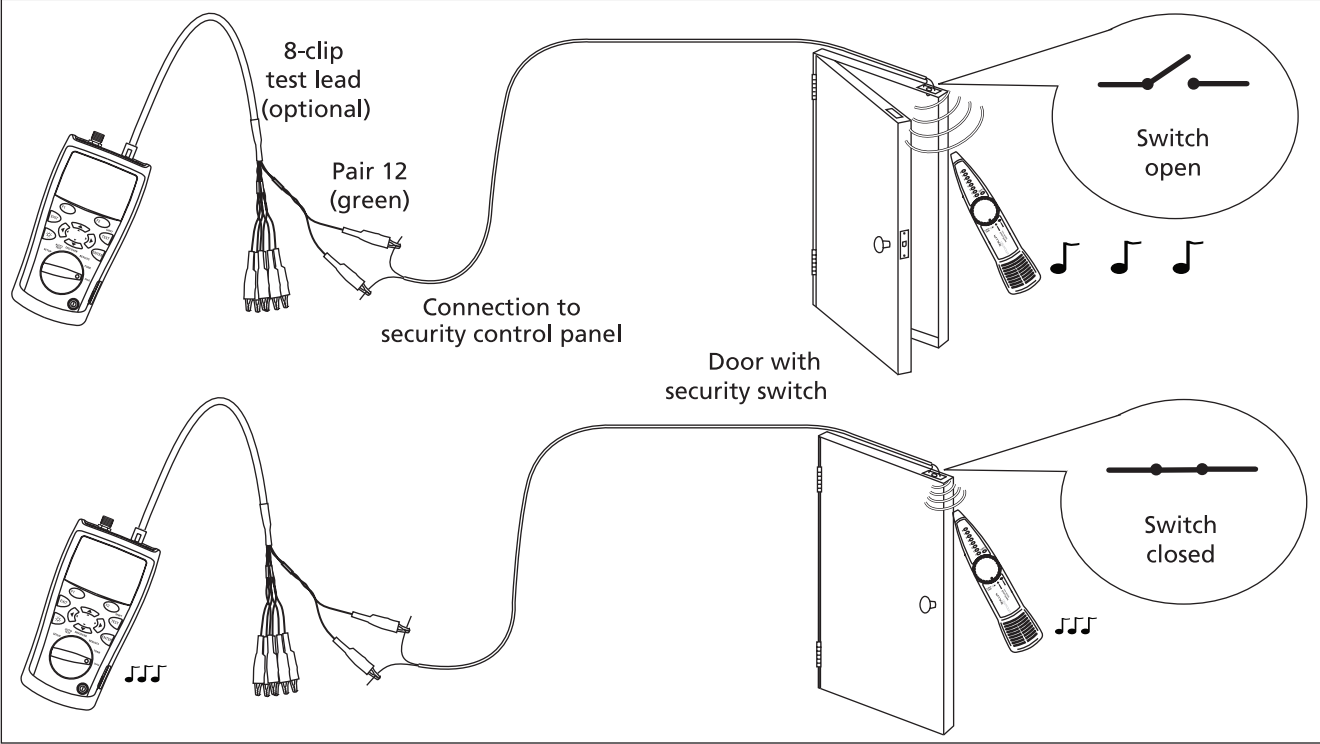

Figure 24. Using the Continuity Toner to Test Security Switches

avv38f.eps

## Locating Crosstalk and Impedance Faults on Twisted Pair Cabling

The **Find Crosstalk Fault** and **Find Impedance Fault** functions let you quickly check cable pairs for crosstalk and impedance faults on twisted pair cabling.

Crosstalk is unwanted signal transmission between cable pairs. Crosstalk can cause transmission errors in twisted pair networks.

Impedance is electrical resistance to ac signals, such as data and CATV transmissions. Impedance changes cause signal reflections that can disrupt network operation and cause poor CATV reception.

To find crosstalk or impedance faults:

### Note

*If you use patch cords at the near or far end during crosstalk or impedance tests, Fluke Networks recommends patch cords at least 2 m long.*













- 1 Connect the tester to twisted pair cabling. A wiremap adapter or ID locator is not required.
- 2 Turn the rotary switch to **DIAG**.
- 3 Use  to highlight **Find Crosstalk Fault** or **Find Impedance Fault**; then press  or .
- 4 To change the transmission standard, press  or , use  to select a standard; then press .
- 5 To select a cable pair or pairs to test, press  to highlight the pair(s), press  or , use  to select a pair or pairs; then press .
- 6 Press  to start the test.

Table 3 describes the crosstalk and impedance fault messages.





**Table 3. Crosstalk and Impedance Fault Messages**

<b>Cabling too short for diagnostics</b>	No cabling is connected to the tester, or the cabling is too short to test.
<b>Cabling too long for diagnostics</b>	The cabling's length is beyond the tester's range.
<b>No significant crosstalk No significant impedance fault</b>	The crosstalk or impedance is acceptable for the selected application.
<b>Crosstalk fault Impedance fault</b>	A localized crosstalk or impedance problem was detected. Localized faults are usually caused by bad connections. Check the cabling at the location given.
<b>Distributed crosstalk faults Distributed imped. faults</b>	Crosstalk or an impedance problem was detected along most or all of the cabling. The cabling is of poor quality or is the wrong category for the selected application.
<b>Marginal ELFEXT for 1000BASE-T</b>	Equal-level far-end crosstalk measurements are marginal.
<b>Short or possible bridge tap</b>	The impedance is very low at the location given. Check for a short or bridge tap.

## Testing Speaker Cabling

The **Speaker Test** generates audible tones for testing the wiring and phase of installed twisted pair speaker cabling.

To test speaker cabling:

- 1 Connect the tester to the cabling as shown in Figure 25.
- 2 Turn the rotary switch to **DIAG**.
- 3 Use  to highlight **Speaker Test**; then press , , or .
- 4 If the cabling and connections are good, you will hear the tester's tones on the left and right speakers.

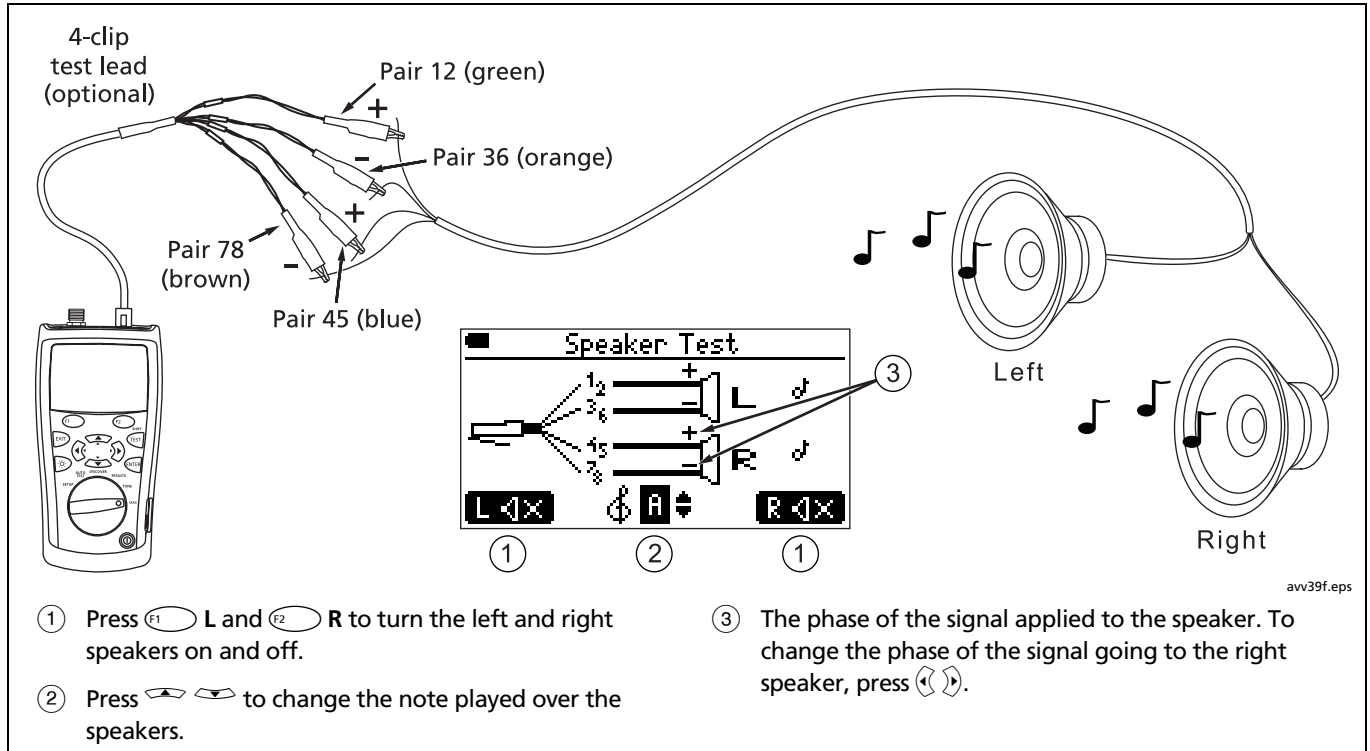

Figure 25. Testing Speaker Cabling

## Calibrating Length Measurements

The tester uses an NVP value (nominal velocity of propagation) and the signal delay through the cable to calculate length. The tester's default NVP values are usually accurate enough to verify length; however, you can increase the accuracy of length measurements by adjusting the NVP to a specified or actual value.



The default NVP values are 70 % for twisted pair cable and 82 % for coaxial cable.

### Note

*NVP values can vary among cable types, lots, and manufacturers. In most cases, these differences are minor and may be disregarded.*







## Setting the NVP to a Specified Value

To enter the NVP value specified by the manufacturer:

- 1 Disconnect twisted pair and coaxial cables from the tester.
- 2 Turn the rotary switch to **SETUP**.
- 3 Use  to highlight **Length Calibration**; then press  or .

### Note

*You may disregard the message "Cabling too short" when setting the NVP to a specified value.*

- 4 To set the NVP for coaxial cable, press  .
- 5 Press  or ; then use   to set the NVP value.
- 6 Press  to save the NVP value.

## Determining a Cable's Actual NVP

You can determine a cable's actual NVP by adjusting the measured length to match a known length of cable.











To determine a cable's NVP:

- 1 Connect a known length of the cable to be tested to the tester's twisted pair or coaxial connector. The cable length must be as follows (as measured using the tester's default NVP values):
  - Twisted pair, Cat 6A and below: 34.4 ft to 689.7 ft (10.5 m to 210.2 m)
  - Coaxial: 40.3 ft to 807.9 ft (12.3 m to 246.2 m)

**Tip:** For maximum accuracy and adjustment resolution, use a cable between 45 ft and 70 ft (14 m and 21 m) long.

### Note





*The cable must not be connected to a wiremap adapter, port, or other device.*

- 2 Turn the rotary switch to **SETUP**.
- 3 Use  to highlight **Length Calibration**; then press  or .
- 4 To set the NVP for coaxial cable, press  .
- 5 Press  or ; then use   to change the NVP until the measured length matches the actual length of the cable.
- 6 Press  to save the NVP value.









## Memory Functions

The tester can store up to 250 Autotest results in non-volatile memory. Other tests cannot be saved.

### Viewing Saved Results

- 1 Turn the rotary switch to **RESULTS**.
- 2 Use , , or **SHIFT** +  to move through the list and highlight a test to view.
- 3 Press  or  to view the highlighted test.

### Deleting Results

- 1 Turn the rotary switch to **RESULTS**.
- 2 To select one result to delete, use , , or **SHIFT** +  to move through the list and highlight the test.
- 3 Press  **Del**.
- 4 Use  to select **Delete Selected Test** or **Delete All Tests**; then press  or  **Del**.
- 5 If you selected **Delete All Tests**, press  to confirm your choice.

## Uploading Results to a PC

CableIQ Reporter software lets you upload Autotest results to a PC, view results, and customize and print test reports.

To upload results to a PC:

- 1 Install the latest version of CableIQ Reporter on your PC. CableIQ Reporter is available on the Fluke Networks website.
- 2 Turn on the tester.
- 3 Connect the tester to the PC using the USB cable provided.
- 4 On the CableIQ Reporter toolbar, click ; then select **CableIQ**.

Details about using CableIQ Reporter software are provided in the online help available under Help on the CableIQ Reporter menu.



## Maintenance

### Warning

To avoid possible fire, electric shock, personal injury, or damage to the tester:

- Do not open the case. No user-serviceable parts are inside.
- Replacing electrical parts yourself will void the tester's warranty and might compromise its safety features.
- Use only specified replacement parts for user-replaceable items.
- Use only Fluke Networks authorized service centers.

### Updating the Tester's Software

Keeping your tester's software current gives you access to the latest features. Software updates are available on the Fluke Networks website.

To see the software version installed in your tester select **Version Information** from the Setup menu. See "Checking the Hardware and Software Versions" on page 15 for details.

To determine if your tester needs a software update visit the Fluke Networks website to see if an update is available.

### Caution

To avoid unexpected loss of power, verify that the tester's battery level is at least 50 % before updating the software.

Updating the software deletes saved results from memory. If you need these results, use CableIQ Reporter software to upload them to a PC before updating the tester's software.

### Note

*Changes to the update procedure may be posted on the CableIQ Qualification Tester software page on the Fluke Networks website.*

To update the tester's software:

- 1 If you want to save any of the Autotests stored in the tester, use CableIQ Reporter software to upload them to a PC.
- 2 Download the latest versions of CableIQ Reporter software and the CableIQ update file from the Fluke Networks website, or contact Fluke Networks to get the files by other means. The files are available at [www.flukenetworks.com/support](http://www.flukenetworks.com/support). Save the files to your hard drive.
- 3 Install the latest version of CableIQ Reporter on your PC.
- 4 Turn on the tester and connect it to the PC using the USB cable provided.
- 5 On the CableIQ Reporter menu bar, select **Utilities > Update CableIQ Software**, locate and select the CableIQ update file (.ref extension); then click **OK**.
- 6 To verify the update, turn the rotary switch to **SETUP**; then select **Version Information**.

If the software update fails, repeat steps 4 through 6. If it fails again, contact Fluke Networks for assistance.

## Replacing the Batteries

Replace the 4 AA batteries when the message **Low Batteries!** appears.

### Note

*Install new batteries within 3 minutes of removing the old batteries. If you leave the batteries out for more than 3 minutes, the time and date may need to be reset.*

*The tester's battery gauge is most accurate when alkaline batteries are installed.*

Figure 26 shows how to replace the batteries.

Remove yellow boot to access battery door.

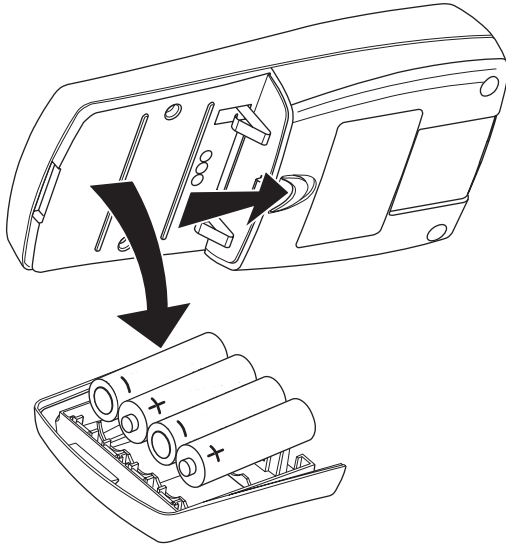

avv53f.eps

**Figure 26. Replacing the Batteries**

## Cleaning

Clean the display with glass cleaner and a soft, lint-free cloth. Clean the case with a soft cloth dampened with water or water and a mild soap.

### **⚠ Caution**

To avoid damaging the display or the case, do not use solvents or abrasive cleansers.

## If Something Seems Wrong

If something seems wrong with the tester, refer to Table 4.

If Table 4 does not help you solve a problem with the tester, contact Fluke Networks for additional help. If possible, have the tester's serial number, software and hardware version numbers available. Select **Version Information** from the Setup menu to see this information.

For warranty information, refer to the warranty at the beginning of this manual. If the warranty has lapsed, contact Fluke Networks for repair prices.

**Table 4. Troubleshooting the Tester**

<b>Symptom 1: The keypad does not respond.</b>
Press and hold Ⓞ until the tester turns off; then turn the tester on again.
<b>Symptom 2: The tester reports an error.</b>
Note the error number or type. Turn the rotary switch to a new position or cycle the power to clear the error. If the error persists, contact Fluke Networks for assistance.
<b>Symptom 3: The tester will not turn on.</b>
Replace the batteries, verifying that they are installed correctly. See Figure 26.
<b>Symptom 4: Length measurements are incorrect.</b>
Check the NVP value. See “Calibrating Length Measurements” on page 60.
<b>Symptom 5: Distance to a switch or hub does not appear, is changing, or is incorrect.</b>
The device’s termination is affecting measurements. See page 40.

## Options and Accessories

To order options and accessories (Table 5), contact Fluke Networks.

For the latest list of options and accessories visit the Fluke Networks website at [www.flukenetworks.com](http://www.flukenetworks.com).

**Table 5. Options and Accessories**

Option or Accessory	Fluke Networks Model Number
Remote ID Locator Kit, numbers 2-4	CIQ-IDK24
Remote ID Locator Kit, numbers 5-7	CIQ-IDK57
Test lead, 8-pin modular plug (RJ45) to 8 alligator clips	CLIP-SET
Test lead, 8-pin modular plug (RJ45) to 4 alligator clips	CIQ-SPKR
Coaxial Adapter Kit (F-connector barrel adapter, female-to-female BNC adapter, female-to-female RCA adapter)	CIQ-COAX
Universal adapter, 8-pin/4-pin modular jack to 8-pin/4-pin modular jack	CIQ-RJA
Wire map adapter	CIQ-WM

## Specifications

Specifications apply at 23 °C (73 °F), unless otherwise noted.

### Environmental Specifications

<b>Operating temperature</b>	32 °F to 104 °F (0 °C to 40 °C)
<b>Storage temperature</b>	-4 °F to +140 °F (-20 °C to +60 °C)
<b>Operating relative humidity (% RH without condensation)</b>	90 % (50 °F to 95 °F; 10 °C to 35 °C) 75 % (95 °F to 104 °F; 35 °C to 40 °C)
<b>Vibration</b>	Random, 2 g, 5 Hz-500 Hz
<b>Shock</b>	1 m drop test with and without wire map adapter attached
<b>Safety</b>	EN 61010-1:2001
<b>Altitude</b>	4,000 m; Storage: 12,000 m
<b>EMC</b>	EN 61326-1: Portable

## General Specifications

<b>Test connectors</b>	Shielded 8-pin modular jack accepts 8-pin modular (RJ45) and 4-pin modular (RJ11) plugs. F-connector for coaxial cable
<b>Power</b>	Battery type: 4 AA (NEDA 15A, IEC LR6) alkaline batteries Battery life: 20 hours of typical use, without backlight Other compatible battery types: 4 AA photo lithium, NIMH, NICAD
<b>Serial interface</b>	USB mini-B 5-pin connector
<b>Dimensions and weight</b>	7 in x 3.5 in x 1.75in 17.8 cm x 8.9 cm x 4.5 cm 1.2 lb (0.55 kg)
<b>Display</b>	2.5 in (5.6 cm) 128 dots wide by 128 dots high monochrome LCD with backlight
<b>Service period</b>	Fluke Networks recommends the tester's operation be verified at a Fluke Networks authorized service center every 12 months.

## Performance Specifications

<b>Qualification Autotests</b>	1000BASE-T, 100BASE-TX, 10BASE-T, VoIP, wiremap only, 1394b S100 (Firewire), Telco, 75 $\Omega$ coaxial
<b>Autotest speed</b>	4 seconds (typical)
<b>Autotest storage</b>	Up to 250 Autotests
<b>Length test</b> (twisted pair, Cat 6A and below)	<p><b>Range:</b> 300 m (1000 ft)</p> <p><b>Resolution:</b> 0.1 m ( 0.1 ft)</p> <p><b>Typical accuracy:</b> <math>\pm 4\%</math> or 2 ft whichever is greater. NVP uncertainty is an additional error</p> <p><b>Calibration:</b> User-settable NVP for twisted pair and coax. Can determine actual NVP with known length of cable.</p>
<b>Wiremap test</b>	Detects single-wire faults. MultiMap function reports wiremaps for up to 7 remote ID adapters. Draws proportional wire length to breaks. Detects split pairs.
<b>Signal performance</b>	Measures crosstalk and return loss characteristics in frequency range of 1-100 MHz.
<b>Voltage protection</b>	Protected against ISDN, PoE and telephone voltages.



### Performance Specifications (cont.)

<b>Tone generator</b>	Generates digital tones compatible with Fluke Networks IntelliTone probe and 4 tones compatible with typical analog probes (all pairs, frequency 1-2 kHz).
<b>Continuity test</b>	<p><b>Resistance range:</b> 0 <math>\Omega</math> to 10,000 <math>\Omega</math></p> <p><b>Tone generation:</b> Variable tone between 500 <math>\Omega</math> and 5,000 <math>\Omega</math>. Tone is audible and can also be detected by a tone probe.</p>
<b>Speaker test tone generator</b>	Variable frequency with left and right speaker and polarity control.
<b>Crosstalk and impedance fault diagnostics</b>	<p>Identifies distributed and localized crosstalk and impedance faults on twisted pair cabling.</p> <p>Minimum and maximum lengths (using default NVP values):</p> <p>Twisted pair, Cat 6A and below: 3.4 m to 210.1 m (11.0 ft to 689.2 ft)</p> <p>Coaxial: 3.9 m to 246.0 m (12.9 ft to 807.4 ft)</p>

### Regulatory Information

This equipment generates, uses, and can radiate radio frequency energy, and, if not installed and used in accordance with the manual, may cause interference to radio communications. It has been tested and found to comply with the limits for a Class A digital device pursuant to Part 15, Subpart J of the FCC rules, which are designed to provide reasonable protection against such interference when operated in a commercial environment. Operation of the equipment in a

residential area is likely to cause interference, in which case the user, at his own expense, will be required to take whatever measures may be required to correct the interference.



## Appendix A: Diagnosing Cabling Faults

Appendix A lists the typical causes of cable test failures.

### **Wire map: open**

- Wires connected to wrong pins at connector or punchdown blocks
- Faulty connections
- Damaged connector
- Damaged cable
- Wrong pairs selected in setup
- Wrong application for cable

-continued-

**Wire map: split pair**

Wires connected to wrong pins at connector or punchdown block.

**Wire map: reversed pairs**

Wires connected to wrong pins at connector or punchdown block.

**Wire map: crossed pairs**

- Wires connected to wrong pins at connector or punchdown block.
- Mix of 568A and 568B wiring standards (12 and 36 crossed).
- Crossover cables used where not needed (12 and 36 crossed).

**Wire map: short**

- Damaged connector
- Damaged cable
- Conductive material stuck between pins at connector.
- Improper connector termination
- Wrong application for cable

-continued-

**Crosstalk or ELFEXT fault**

- Excessive untwisting of pairs at connector
- Poor quality patch cords
- Poor quality connectors
- Poor quality cable
- Cable compression (tight cable ties, pinches, kinks, etc.)
- Inappropriate use of couplers
- Electrical noise source near cabling
- Wrong application selected

-continued-

#### **Impedance fault**

- Patch cord or cable impedance not 100  $\Omega$  (impedance mismatch)
- Patch cord handling causing changes in impedance
- Excessive amount of cable jammed into outlet box
- Tight service loops in the distribution box
- Excessive untwisting of pairs at connector
- Poor quality connectors
- Cable impedance not uniform
- Cable compression (tight cable ties, pinches, kinks, etc.)
- Poorly matched plug and jack
- Water in cable jacket
- Wrong application selected

-continued-

**Insertion loss (attenuation) fault**

- Cable is too long
- Poor quality patch cord
- Bad connection
- Wrong cable type installed
- Wrong application selected

**Length exceeds limit, or delay skew fails**

- Cable is too long (may need to remove coiled service loops)





# Index

## —A—

- accessories
  - optional, 67
  - standard, 3
- adapter, 10
- auto shutoff, 14
- Autotest
  - coaxial, 32
  - parameters, 17
  - saving, 19, 32
  - setup, 18
  - twisted pair, 19
    - length results, 30
    - results overview, 24
  - Signal Performance, 28
  - wiremap results, 25

## —B—

- backlight, 9
- batteries
  - replacement, 64
  - type and life, 11
- beeper, 14
- Blink Port Light, 51
- bridge tap detected
  - Autotest, 27
  - Discover mode, 39
- bus topologies, 22
- buttons, 9

## —C—

- CableQ Reporter software, 62
- cautions, 6

- cleaning, 65
- coaxial
  - Autotest, 32
  - Discover mode, 42
  - TDR, 44
- continuity test, 52
- continuity toner, 54
- crossed pairs, 27
- crosstalk faults, 56
- customer support
  - contacting Fluke Networks, 2
  - if something seems wrong, 65

## —D—

- date, 12
- default settings, 14
- delay skew, 31
- Device

- coaxial result, 36
- port detected, 40
- Discover mode, 37
- coaxial results, 42
- MultiMap, 46
- TDR plot, 44
- twisted pair results, 38

### —E—

- editing text, 13

### —F—

- Factory Settings, 14
- FDX, 40
- Find Crosstalk Fault, 56
- Find Impedance Fault, 56
- Fluke Networks
  - contacting, 2
  - Knowledge Base, 3
- front panel, 9

### —H—

- hardware version, 15
- help (customer support), 65
- high voltage, 6, 41

### —I—

- icons for pair terminations, 30, 39
- impedance faults, 56
- INACTIVE PORT, 40
- IntelliTone
  - cable map function, 50
  - tone function, 48
- ISDN, 6

### —K—

- keys, 9
- Knowledge Base, 3

### —L—

- language, 11
- length
  - calibrating, 60
  - test results, 30
  - units, 11
- length to a port, 40
- Location, 19, 32

### —M—

- maintenance, 63

- memory functions, 62
- MultiMap, 46

### —N—

- non-negotiating port, 19
- NP, 40
- NVP, 60

### —O—

- open, 25
- options, 67
- Outlet, 19, 32

### —P—

- Pairs screen icons, 30, 39
- parts, 67
- port detected (Discover mode), 40
- power
  - auto shutoff, 14
  - powering the tester, 11
- Power over Ethernet, 6
- problems (with the tester), 65

—Q—

qualification vs. certification, 16

—R—

registration, 2  
remote ID locator, 10  
replacement parts, 67  
reset to defaults, 14

—S—

safety information, 6  
saving Autotests, 19, 32  
self-test, 11  
service, 65  
setup  
    Autotest, 18  
    user preferences, 11  
short  
    Autotest, 19  
    coaxial, 35  
    twisted pair, 41

Signal Level, 42, 43  
Signal Performance, 28  
Site, 19, 32  
software  
    CableIQ Reporter, 62  
    updates, 63  
    version, 15  
Speaker, 14  
Speaker Test, 58  
split pair, 26  
Splitter or Fault, 35  
star topologies, 20

—T—

TDR, 44  
telephone voltages, 6, 41  
time, 12  
toner, 48, 54  
troubleshooting  
    cabling faults, 73  
    the tester, 65  
twisted pair  
    Autotest, 19

Discover mode, 38  
Find Fault functions, 56

—U—

updating the software, 63  
uploading results to a PC, 62  
User Information, 12

—V—

Version Information, 15  
VoIP, 22  
voltage alert screens, 6

—W—

warnings, 6, 63  
wiremap adapter, 10  
wiremap results, 25

