

# INSTRUCTION MANUAL

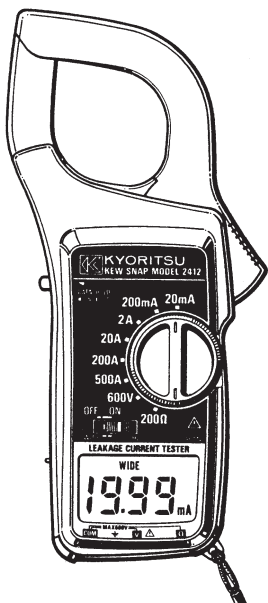

---

DIGITAL AC LEAKAGE CURRENT TESTER

---

**KEW SNAP Series**  
**Model 2412**

---



**KYORITSU ELECTRICAL INSTRUMENTS  
WORKS, LTD.**

# CONTENTS

|   |    |
|---|----|
| 1. SAFETY WARNINGS .....                    | 1  |
| 2. FEATURES .....                           | 4  |
| 3. SPECIFICATIONS .....                     | 5  |
| 4. INSTRUMENT LAYOUT .....                  | 9  |
| 5. PREPARATIONS FOR TESTS .....             | 12 |
| 6. OPERATING INSTRUCTIONS .....             | 13 |
| 6-1 CURRENT MEASUREMENTS .....              | 13 |
| 6-2 FREQUENCY SELECTOR SWITCH .....         | 16 |
| 6-3 VOLTAGE MEASUREMENTS .....              | 17 |
| 6-4 RESISTANCE MEASUREMENTS .....           | 19 |
| 6-5 DATA HOLD .....                         | 20 |
| 6-6 AUTOMATIC POWER OFF .....               | 20 |
| 7. DC OUTPUT VOLTAGE .....                  | 21 |
| 8. TERMINAL FOR EXTERNAL POWER SOURCE ..... | 23 |
| 9. BATTERY REPLACEMENT .....                | 25 |
| 10. OPTIONAL ACCESSORIES .....              | 27 |

# 1. SAFETY WARNINGS

- This instruction manual contains warnings and safety rules which must be observed by the user to ensure safe operation of the instrument and retain it in safe condition. Therefore, read these operating instructions thoroughly and completely before using the instrument.
  - The symbol  $\triangle$  on the instrument means that the user must refer to the relevant section of this instruction manual for safe operation of the instrument.
  - Pay particular attention to all WARNINGS and CAUTIONS in this instruction manual. WARNING indicates warnings to avoid electrical shock and CAUTION indicates cautions to avoid damage to the instrument.
- (1) Do not open the battery compartment cover when making measurements.
  - (2) Always inspect your instrument, test leads and accessories for any sign of damage or abnormality before every use. If any abnormal conditions exist (eg. broken test leads, cracked cases, display not reading, etc.) , do not attempt to carry out any measurements.
  - (3) Never ground yourself when conducting electrical tests. Do not touch exposed metal pipes, outlets, fixtures, etc., which might be at ground potential. Keep your body isolated from ground by using dry clothing, rubber shoes, rubber mats, or any approved insulating material.
  - (4) Never make measurements on a circuit above 600V

## AC.

- (5) Never exceed the maximum allowable input of any function when making measurements.
- (6) Never apply voltage to the Output Terminal.
- (7) Never apply voltage above 11V to the Terminal for External Power Source.
- (8) Always set the Power/Frequency Selector Switch to the OFF position after use.
- (9) The transformer jaws are made of metal and their tips are not insulated. Be especially careful about the hazard of possible shorting where the equipment under test has exposed metal parts.
- (10) Do not make measurements in an explosive atmosphere (i.e. in the presence of flammable gasses or fumes, vapor or dust).
- (11) Make sure to remove the test leads from the instrument before replacing the battery.
- (12) Make sure to remove the test leads from the instrument before making current measurements.
- (13) Never make measurements if the instrument, the test leads or your hand is wet.
- (14) Calibration and repair of any instrument should only be performed by qualified and trained service technicians. Do not attempt calibration or service unless trained and another person capable of rendering first aid and resuscitation is present.
- (15) Do not install substitute parts or perform any unauthorized modification of the instrument. Return the instrument to your distributor or authorized service center for service and repair to insure that safety features are maintained.
- (16) The instrument must be used by a competent, trained

person and operated in strict accordance with the instructions. Kyoritsu Electrical Instruments Works, Ltd will not accept liability for any damage or injury caused by misuse or non-compliance with the instructions or safety procedures. It is essential to read and understand the safety rules contained in the instructions. They must be observed when using the instrument.

- (17) Do not expose the instrument to the direct sun, extreme of temperature more than 50°C or dew fall.
- (18) When not in use for a long period of time, place the instrument in storage after removing the batteries from it.
- (19) Use a damp cloth and detergent for cleaning the case of the instrument. Do not use abrasives or solvents.

## 2. FEATURES

- Designed for measurements of AC leakage and AC current with five ranges from 20mA to 500A. AC 20mA range provides a high resolution of 0.01mA.
- Least affected by external magnetic field.
- Also measures AC voltage up to 600V and resistance up to 200 $\Omega$ .
- Provides dual frequency responses of fundamental 50/60Hz only or up to 1kHz.  
The frequency response of up to 1kHz permits measurements of current with harmonics superimposed on the fundamental frequency. High frequency current from appliances such as inverters, switching regulators etc. can therefore be measured.  
The dual frequency response is also available for AC current range.
- Data hold function to allow for easy readings in dimly light or hard-to-reach locations.
- Large easy-to-read LCD display.
- DC voltage output in proportion to AC current readings is available for connection to a recorder. With external DC 9V power supply, the instrument permits continuous leakage current monitoring.
- Automatic power off within an hour to conserve battery life.
- Designed to international safety standard.

### 3. SPECIFICATIONS

#### ● AC current ranges

at  $23 \pm 10^\circ\text{C}$ , 85% RH

| Ranges |           | Accuracy  |   |
|--------|-----------|---|---|
|        |           | Frequency Selector Switch   |   |
|        |           | WIDE (40Hz~400Hz) position  | 50/60Hz position                        |
| 20mA   | 0~19.99mA | $\pm 1.0\% \text{rdg} \pm 3 \text{dgt}$ (50/60Hz)<br>$\pm 5.0\% \text{rdg} \pm 3 \text{dgt}$ (40Hz~400Hz) | $\pm 1.5\% \text{rdg} \pm 5 \text{dgt}$ |
| 200mA  | 0~199.9mA |   |   |
| 2A     | 0~1.999A  | $\pm 1.5\% \text{rdg} \pm 3 \text{dgt}$ (50/60Hz)<br>$\pm 5.0\% \text{rdg} \pm 3 \text{dgt}$ (40Hz~400Hz) | $\pm 2.0\% \text{rdg} \pm 5 \text{dgt}$ |
| 20A    | 0~19.99A  |   |   |
| 200A   | 0~199.9A  | $\pm 2.0\% \text{rdg} \pm 3 \text{dgt}$ (50/60Hz)<br>$\pm 5.0\% \text{rdg} \pm 3 \text{dgt}$ (40Hz~400Hz) | $\pm 2.5\% \text{rdg} \pm 5 \text{dgt}$ |
| 500A   | 0~500A    |   |   |

#### Frequency Characteristics

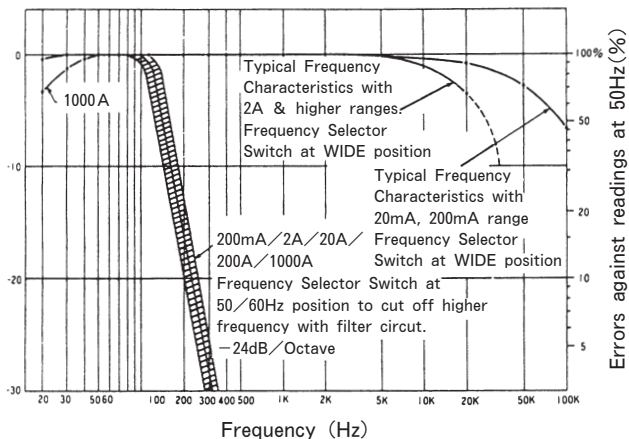

Fig.1

● AC Voltage Range (Frequency selector switch is not available)

| Range |        | Accuracy  |
|-------|--------|---|
| 600V  | 0~600V | $\pm 2.0\%rdg \pm 5dgt$ (50/60Hz)<br>$\pm 5.0\%rdg \pm 5dgt$ (40Hz~400Hz) |

● Resistance Range

| Range |          | Accuracy                |
|-------|----------|-------------------------|
| 200Ω  | 0~199.9Ω | $\pm 1.5\%rdg \pm 5dgt$ |

● DC Output Voltage (for AC current range only)

| Ranges      | Output Voltage | Accuracy  |                          |
|-------------|----------------|---|--------------------------|
|             |                | Frequency Selector Switch   |                          |
|             |                | WIDE(40Hz~400Hz) position   | 50/60Hz position         |
| 20/200mA/2A | 0~199.9mV      | $\pm 1.5\%rdg \pm 0.3mV$ (50/60Hz)<br>$\pm 5.0\%rdg \pm 0.3mV$ (40Hz~400Hz) | $\pm 2.0\%rdg \pm 0.5mV$ |
| 20/200A     |                | $\pm 2.0\%rdg \pm 0.3mV$ (50/60Hz)<br>$\pm 5.0\%rdg \pm 0.3mV$ (40Hz~400Hz) | $\pm 2.5\%rdg \pm 0.5mV$ |
| 500A        | 0~50.0mV       | $\pm 2.5\%rdg \pm 0.3mV$ (50/60Hz)<br>$\pm 5.0\%rdg \pm 0.3mV$ (40Hz~400Hz) | $\pm 3.0\%rdg \pm 0.5mV$ |

● DC Output Voltage is provided as follows except on AC 500A range, but the display shows an overrange indication after exceeding full scale.

| Ranges              | maximun allowable current      | Output Voltage |
|---------------------|--------------------------------|----------------|
| 20mA<br>200mA<br>2A | 0~60.0mA<br>0~600mA<br>0~6.00A | 0~600mV        |
| 20A<br>200A         | 0~40.0A<br>0~400A              | 0~400mV        |

Accuracy is not specified.



|  |   |
|--|---|
| <b>Operating System:</b>                   | Dual integration  |
| <b>Sensing:</b>                            | Average sensing, calibrated in rms of a sinewave  |
| <b>Digital Display:</b>                    | 3-1/2 digit liquid crystal display with maximum reading of 1999   |
| <b>Overrange Indication:</b>               | Numeral "1" on the highest digit flashes except on AC 500A and AC 600V ranges   |
| <b>Response Time:</b>                      | Approx. 2 second on resistance range<br>Approx. 1 second on other ranges  |
| <b>Sample Rate:</b>                        | Approx. three times per second  |
| <b>Data Hold:</b>                          | For all ranges. In Data Hold mode, "H" symbol is displayed on the digital display   |
| <b>Low Battery Indicator:</b>              | "B" symbol is displayed on the digital display.   |
| <b>Storage Temperature and Humidity:</b>   | -10~50°C at 75% max. relative humidity without condensing   |
| <b>Operating Temperature and Humidity:</b> | 0~40°C at 90% max. relative humidity without condensing   |
| <b>Power Source:</b>                       | one 6F22 (DC9V) battery or equivalent, or DC9±2V external power source  |
| <b>Current Consumption:</b>                | Approx. 3mA   |
| <b>Auto Power Off:</b>                     | Automatically turns power off in approx. one hour after the instrument is powered (not applicable when operating from an external power source) |

|                               |   |
|-------------------------------|---|
| <b>Insulation Resistance:</b> | 10M $\Omega$ min. at 1000V between electrical circuit and housing case, and electrical circuit and transformer jaws   |
| <b>Withstand Voltage:</b>     | 3700V AC for 1 minute between electrical circuit and housing case as well as electrical circuit and transformer jaws  |
| <b>Conductor Size:</b>        | Approx. 40mm diameter max.  |
| <b>Dimensions:</b>            | 209(L) $\times$ 96(W) $\times$ 45(D)mm  |
| <b>Weight:</b>                | 450g approx. (battery included)   |
| <b>Accessories:</b>           | 6F22 battery<br>Carrying Case<br>Test Leads Model 7066A<br>Output Plug Model 8025<br>Instruction manual               |
| <b>Optional Accessories:</b>  | AC Adaptor Model 8022 (AC 100V)<br>AC Adaptor Model 8023 (AC 220V)<br>Multi-Tran Model 8008<br>Output Lead Model 7014 |

## 4. INSTRUMENT LAYOUT

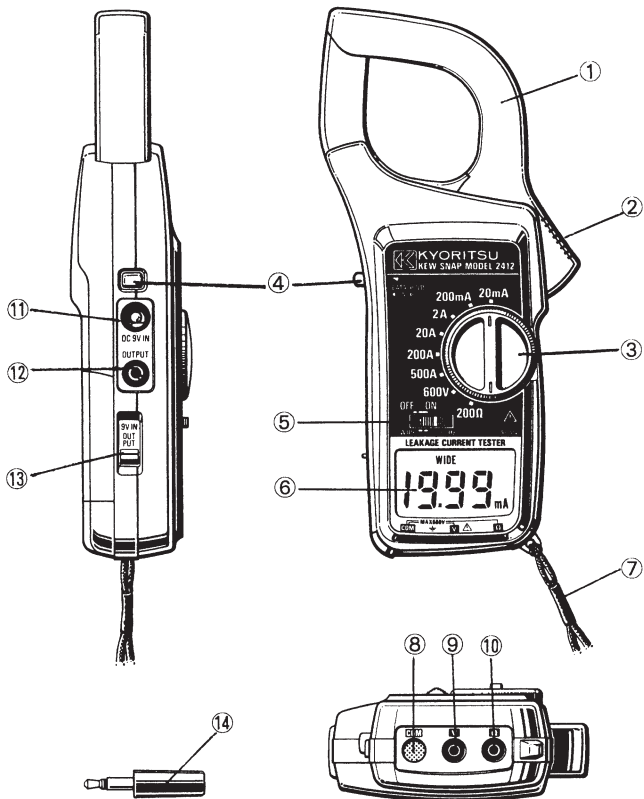
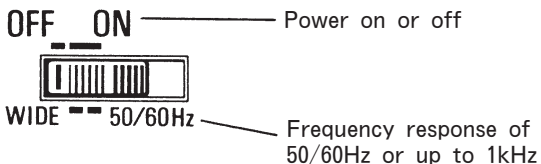

Fig.2

- ① Transformer Jaws  
Pick up current flowing through the conductor.
- ② Jaw Trigger  
Operates the transformer jaws. Press to open them.
- ③ Range Switch  
Selects ranges.
- ④ Data Hold Push Button  
Push to freeze a reading and push again to release it.  
In Data Hold mode, "H" is displayed on the digital display.
- ⑤ Power/Frequency Selector Switch  
Turns power on and then selects frequency response of 50/60Hz or WIDE.



⑥ Digital Display

Function symbols and decimal point are displayed according to the Range Switch position.

Frequency response of WIDE

Frequency response of 50/60 Hz

Low Battery indicator

Data Hold mode indicator

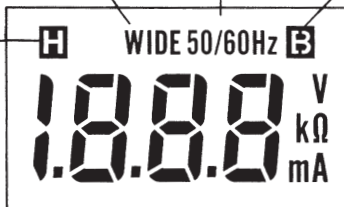

⑦ Safety Hand Strap

⑧ COM Terminal

⑨ VOLT Terminal

⑩ Ω Terminal

⑪ Terminal for External Power Source (for AC current range only)

⑫ Output Terminal (for AC current range only)

Provides DC voltage in proportion to the AC current reading.

⑬ Terminal Cover Knob

Covers the VOLT Terminal when using Output Terminal or Terminal for External Power Source.

⑭ Output Plug

## 5. PREPARATIONS FOR TESTS

### **⚠WARNING**

Always inspect your instrument, test leads and accessories for any sign of damage or abnormality before every use. If any abnormal conditions exist ( eg. broken test leads, cracked cases, display not reading, etc ), do not attempt to conduct any tests.

#### **5-1 Battery Check**

To check the battery voltage set the Power/Frequency Selector Switch to OFF position. If the display is clear without symbol "B" showing, battery voltage is OK. If the display blanks or "B" is indicated, replace the battery according to section 9 for Battery replacement.

### **NOTE**

The instrument automatically turns power off approximately one hour after it is turned on. Therefore the display may be blank with the Power/Frequency Selector Switch set to On position. To operate the instrument, set the switch back to OFF position and then ON position.

#### **5-2 Data Hold Switch**

If the Data Hold Switch is pressed in (DATA HOLD mode ), press to release it. Otherwise, the display remains frozen. When the instrument is in DATA HOLD mode, "H" symbol is indicated on the display.

## 6. OPERATING INSTRUCTIONS

### 6-1 Current Measurements

#### **⚠WARNING**

- Do not make measurements where the potential is greater than 600V AC. This may cause shock hazard and damage to the instrument or equipment under test.
- The Transformer Jaws are made of metal and their tips are not insulated. Be especially careful about the hazard of possible shorting where the equipment under test has exposed metal parts.
- Make sure to remove the test leads from the instrument before replacing the battery.
- Make sure to remove the test leads from the instrument before making current measurements.
- Do not open the battery compartment cover when making measurements.

#### **⚠CAUTION**

- Take sufficient care to avoid shock, vibration or excessive force when handling the instrument. Otherwise, precisely adjusted Transformer Jaws will be damaged.
- When Transformer Jaws do not fully close, never try to close them by force, but make them free to move and try again. If a foreign substance is stuck in the jaw tips, remove it. If the jaw tips have been deformed, correct so that each tip is properly aligned. Otherwise, the jaws will be damaged and warranty may not cover the repair cost.

## NOTE

- When making current measurements, keep the Transformer Jaws fully closed. Otherwise, accurate measurements cannot be taken. Maximum conductor size is 40mm in diameter.
  - When measuring larger current, the Transformer Jaws may buzz. This is not a fault and does not affect the accuracy either.
- (1) Set the Range Switch to the desired "A" or "mA" position.
  - (2) Select the desired frequency response, WIDE or 50/60Hz, with the Power/Frequency Selector Switch. (see 6-2 for Frequency Selector Switch)

## ⚠CAUTION

Do not exceed maximum allowable current on each current range. (see 3 for Specifications)

- (3) Press the Trigger to open the Transformer Jaws and clamp onto a conductor or conductors as follows.  
Take the reading on the display.

## NOTE

- For more accurate measurements, place the conductor at the center of the closed jaws.
- When measuring current on a line or a grounded wire, clamp onto one conductor only.



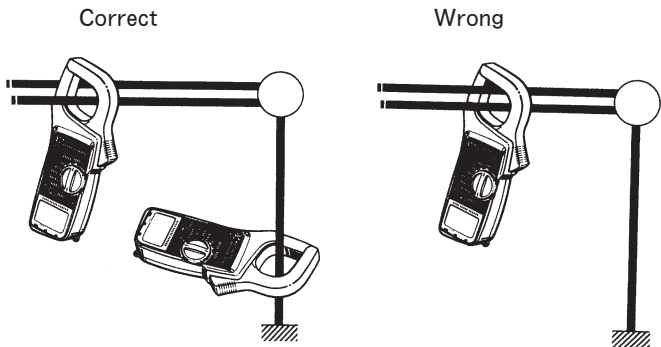
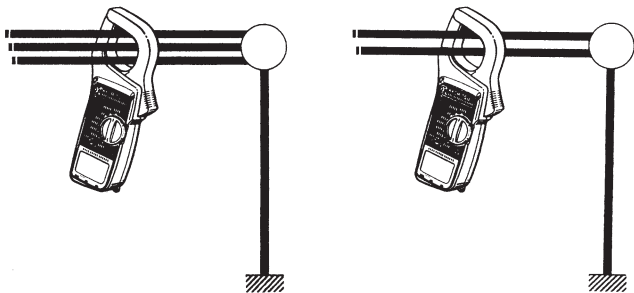

Fig.3

- When measuring out of balance leakage current, clamp onto all conductors except a grounded wire.



Three-phase system

Single-phase system

Fig.4

## 6-2 Frequency Selector Switch

(available on AC current ranges)

Model 2412 measures AC currents of:

- (1) 50/60Hz fundamental frequency only with the Frequency Selector Switch set to the 50/60Hz position ("50/60Hz" is indicated on the display),  
or
- (2) 40Hz to 1kHz with the Frequency Selector Switch set to the WIDE position ("WIDE" is indicated on the display)

Frequency response of 40Hz to 1kHz permits measurements of current with harmonics superimposed on the fundamental frequency. High frequency current from appliances such as inverters, switching regulators etc. can therefore be measured.

### NOTE

- Frequency response is not selectable on AC voltage range.
- Model 2412 has a very good frequency response due to the electrical property of the transformer jaws used for the instrument. Therefore, it measures AC current of not only 50Hz or 60Hz fundamental wave form but also of higher frequencies and harmonics superimposed on the fundamental frequency when present in the circuit under test.

To eliminate the effect of noise from the high frequency and measure AC current of 50Hz or 60Hz fundamental frequency, a filter circuit is incorporated into the Model 2412 which works when the frequency selector switch is set to the 50/60Hz position.

## 6-3 AC Voltage Measurements

### **⚠WARNING**

- Do not make measurements where the potential is greater than 600V AC. This may cause shock hazard and damage to the instrument or equipment under test.
- Do not open the battery compartment cover when making measurements. This may cause shock hazard.

### **⚠CAUTION**

- Before taking measurements, always make sure that the plugs of the test leads are inserted into the COMMON and VOLT terminals. Applying voltage to the  $\Omega$  Terminal damages the instrument.

- (1) Set the Range Switch to the 600V position.
- (2) Slide up the Terminal Cover Knob to disclose the COMMON Terminal.

### **NOTE**

- Output Terminal and the Terminal for External Power Source, and COMMON Terminal cannot be used at the same time because of the terminal cover. This is to prevent electrical hazard and damage to the instrument.

| Terminal Cover Knob position | Terminal for External Power Source | Output Terminal | COMMON Terminal |
|------------------------------|------------------------------------|-----------------|-----------------|
| up                           | not available                      | not available   | available       |
| down                         | available                          | available       | not available   |

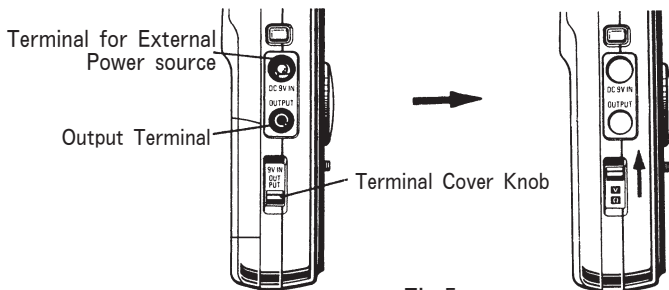

Fig.5

- (3) Insert the red plug of the test leads into the VOLT Terminal and the black plug into the COMMON Terminal. (Fig. 6)

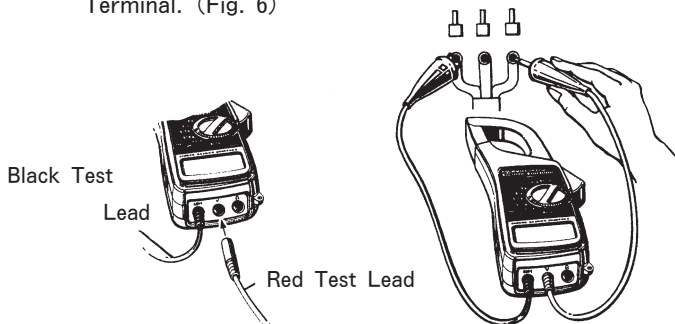

Fig.6

Fig.7

- (4) Connect the clips of the test leads to the circuit under test. Take the reading on the digital display. (Fig. 7)

#### **NOTE**

- It is recommended to connect the black clip of the test lead (i.e. the COMMON Terminal) to the ground side of the circuit under test.

### **6-4 Resistance Measurements**

#### **⚠WARNING**

- To avoid possible electrical shock and instrument damage, do not measure resistance on an energized (LIVE) circuit.
  - Do not open the battery compartment cover when making measurements. This may cause shock hazard.
- (1) Set the Range Switch to  $200\Omega$  position.
  - (2) Slide up the Terminal Cover Knob to uncover the COMMON Terminal. (See Fig.5)
  - (3) Insert the red plug of the test leads into the  $\Omega$  Terminal and the black plug into the COMMON Terminal. (Fig.8)
  - (4) Connect the clips of the test leads to the circuit under test. Take the reading on the digital display. (Fig.9)

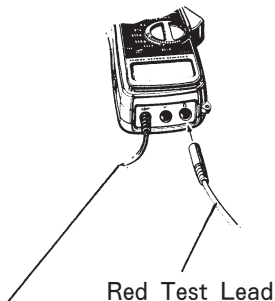

Red Test Lead

Black Test Lead

Fig.8

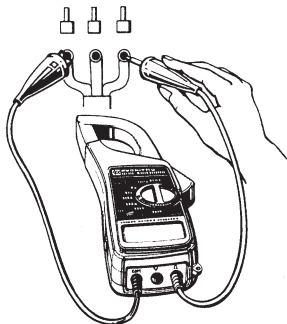

Fig.9

#### 6-5 Date Hold

Push the Date Hold Switch Button to freeze the reading. "H" symbol is displayed on the digital display to indicate that the instrument is in Data Hold mode.

Push the button again to exit from Data Hold mode.

#### 6-6 Automatic Power Off

Model 2412 automatically turns power off in approx. one hour after it is turned on. To operate the instrument, set the Power/Frequency Selector Switch back to OFF position and then ON position.

This function is not applicable when operating from an external power source.

#### NOTE

Use external power source (optional AC adaptor Model 8022 or 8023, or DC 9V power supply) for continuous measurement for more than one hour.

## 7. DC OUTPUT VOLTAGE (available on AC current ranges only)

- (1) Slide down the Terminal Cover Knob to disclose the Output Terminal.
- (2) Insert into the Output Terminal the attached plug connected with a lead as per Fig.10 or optional Output Lead Model 7014. (Fig.11)
- (3) Connect the other end of the lead to equipment such as an recorder.

### **⚠ CAUTION**

Do not apply voltage to the Output Terminal. It will damage the instrument.

### **NOTE**

- When continuously monitoring for more than one hour, use external power source (optional AC adaptor Model 8022 or 8023, or DC 9V power supply).  
Otherwise, the instrument will automatically turn power off within one hour after it is turned on.
- Frequency select function works on output voltage as well as on AC current reading. Refer to section 3 for Specifications.

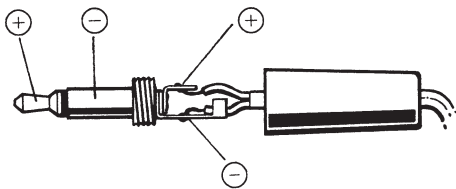
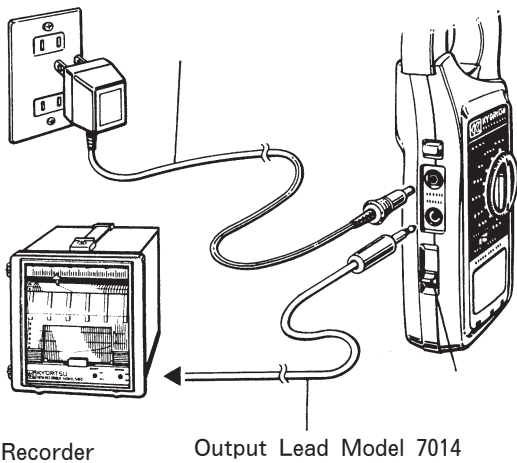

Fig.10



Recorder

Output Lead Model 7014

Fig.11



## 8. TERMINAL FOR EXTERNAL POWER SOURCE

- (1) Slide down the Terminal Cover Knob to disclose the Terminal for External Power Source.
- (2) Connect an AC adaptor (optional Model 8022 or 8023 is recommended) or DC power source to the terminal.

The AC adaptor or DC power source must have positive polarity on the outer contact of its output plug and be rated at;

(1)Output voltage : DC  $9V \pm 2V$

(2)Output current : DC 25mA

### **△WARNING**

- Never use the instrument with the battery compartment cover removed from it.
- Make sure to remove the test leads before connecting the AC adaptor for the an external power source.
- Use an AC adaptor or external power supply of the above ratings and designed to relevant safety standards.

### **△CAUTION**

Use only an AC adaptor or DC power source of the above ratings. Otherwise, the instrument will be damaged.

AC adaptor Model 8022

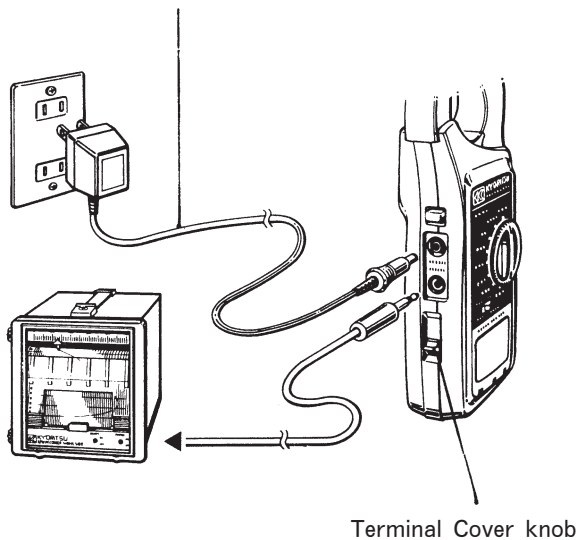

Fig.12

## 9. BATTERY REPLACEMENT

### 9-1 When to replace the battery

- (1) When "B" symbol is displayed on the digital display.
- (2) When the digital display does not read with the Power/Frequency Selector Switch set to ON position.

### 9-2 Battery replacement

- (1) Set the Power/Frequency Selector Switch to OFF position.
- (2) Remove all leads and connections from the instrument.
- (3) Unscrew and remove the battery compartment cover.
- (4) Replace the battery with a new 9V battery type 6F22 or equivalent, observing correct polarity.

#### **⚠WARNING**

Never replace the battery during measurement.

(5) Screw the battery compartment cover.

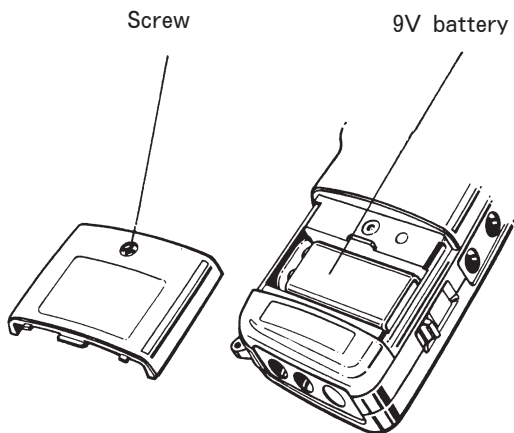

Fig.13

## 10. OPTIONAL ACCESSORIES

### 10-1 Model 8008 (Multi-Tran)

Model 8008 is a clamp-on current transformer designed to measure AC current up to 3000A in conjunction with a clamp meter. It clamps on large bus-bars (up to 150×100 mm) and conductors (up to 100mm diameter)

As shown, clamp on a conductor with Model 8008 that pickup coil also clamped with Model 2412. Then take the reading and multiply it by 10.

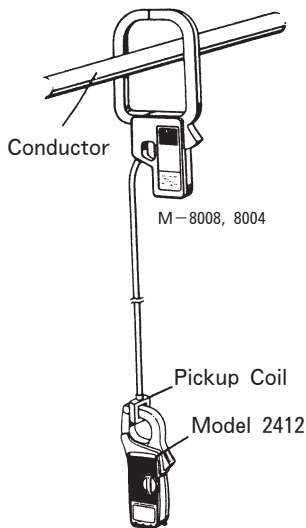

Fig.14

### NOTE

Multi-Tran cannot be used for leakage current measurement.

## **10-2 Model 8022 and 8023 (AC Adaptor)**

Ratings are as follows;

Model 8022 : Input voltage AC 100V~120V (50/60Hz)

Output voltage DC 9V

Output current DC 25mA

Model 8023 : Input voltage AC 200V~240V (50/60Hz)

Output voltage DC 9V

Output current DC 25mA

(see Fig.12)

## **10-3 Model 7014 (Output Lead)**

Model 7014 is a lead to provide DC output voltage for equipment such as a recorder from the Output Terminal.

(see Fig.11)

# MEMO

**DISTRIBUTOR**

Kyoritsu reserves the rights to change specifications or designs described in this manual without notice and without obligations.



**KYORITSU ELECTRICAL  
INSTRUMENTS  
WORKS, LTD.**

No.5-20,Nakane 2-chome, Meguro-ku,

Tokyo, 152-0031 Japan

Phone: +81-3-3723-0131

Fax: +81-3-3723-0152

Factory: Ehime

**[www.kew-ltd.co.jp](http://www.kew-ltd.co.jp)**