

CONTACTOR, AC-3 18,5 KW/400 V, AC 230V 50/60HZ 3-POLE,
SIZE S2, SCREW CONNECTION



Figure similar

product brand name	SIRIUS
Product designation	power contactor
General technical data:	
Size of contactor	S2
Insulation voltage	
• rated value	690 V
Degree of pollution	3
Surge voltage resistance rated value	6 kV
maximum permissible voltage for safe isolation	
• between coil and main contacts acc. to EN 60947-1	400 V
Protection class IP	
• on the front	IP00
• of the terminal	IP00
Shock resistance	
• at rectangular impulse	
— at AC	10g / 5 ms, 5g / 10 ms
• with sine pulse	
— at AC	15g / 5 ms, 8g / 10 ms

Mechanical service life (switching cycles)	
<ul style="list-style-type: none"> • of contactor typical 	10 000 000
<ul style="list-style-type: none"> • of the contactor with added electronics-compatible auxiliary switch block typical 	5 000 000
<ul style="list-style-type: none"> • of the contactor with added auxiliary switch block typical 	10 000 000
Ambient conditions:	
Installation altitude at height above sea level maximum	2 000 m
Ambient temperature	
<ul style="list-style-type: none"> • during operation 	-25 ... +60 °C
<ul style="list-style-type: none"> • during storage 	-55 ... +80 °C
Main circuit:	
Number of NO contacts for main contacts	3
Number of NC contacts for main contacts	0
Operating current	
<ul style="list-style-type: none"> • at AC-1 at 400 V <ul style="list-style-type: none"> — at ambient temperature 40 °C rated value 	60 A
<ul style="list-style-type: none"> • at AC-1 up to 690 V <ul style="list-style-type: none"> — at ambient temperature 40 °C rated value — at ambient temperature 60 °C rated value 	60 A 55 A
<ul style="list-style-type: none"> • at AC-3 <ul style="list-style-type: none"> — at 400 V rated value — at 690 V rated value 	40 A 24 A
Connectable conductor cross-section in main circuit at AC-1	
<ul style="list-style-type: none"> • at 60 °C minimum permissible 	16 mm ²
<ul style="list-style-type: none"> • at 40 °C minimum permissible 	16 mm ²
Operating current for approx. 200000 operating cycles at AC-4	
<ul style="list-style-type: none"> • at 400 V rated value 	18.5 A
<ul style="list-style-type: none"> • at 690 V rated value 	12.6 A
Operating current	
<ul style="list-style-type: none"> • at 1 current path at DC-1 <ul style="list-style-type: none"> — at 24 V rated value — at 110 V rated value 	55 A 4.5 A
<ul style="list-style-type: none"> • with 2 current paths in series at DC-1 <ul style="list-style-type: none"> — at 24 V rated value — at 110 V rated value 	55 A 25 A
<ul style="list-style-type: none"> • with 3 current paths in series at DC-1 <ul style="list-style-type: none"> — at 24 V rated value — at 110 V rated value 	55 A 55 A

Operating current	
<ul style="list-style-type: none"> • at 1 current path at DC-3 at DC-5 <ul style="list-style-type: none"> — at 24 V rated value — at 110 V rated value • with 2 current paths in series at DC-3 at DC-5 <ul style="list-style-type: none"> — at 110 V rated value — at 24 V rated value • with 3 current paths in series at DC-3 at DC-5 <ul style="list-style-type: none"> — at 110 V rated value — at 24 V rated value 	<p>35 A</p> <p>2.5 A</p> <p>25 A</p> <p>55 A</p> <p>55 A</p> <p>55 A</p>
Operating power	
<ul style="list-style-type: none"> • at AC-1 <ul style="list-style-type: none"> — at 230 V at 60 °C rated value — at 400 V rated value — at 690 V rated value — at 690 V at 60 °C rated value • at AC-2 at 400 V rated value • at AC-3 <ul style="list-style-type: none"> — at 230 V rated value — at 400 V rated value — at 500 V rated value — at 690 V rated value 	<p>22 kW</p> <p>38 kW</p> <p>66 kW</p> <p>66 kW</p> <p>18.5 kW</p> <p>11 kW</p> <p>18.5 kW</p> <p>22 kW</p> <p>22 kW</p>
Operating power for approx. 200000 operating cycles at AC-4	
<ul style="list-style-type: none"> • at 400 V rated value • at 690 V rated value 	<p>9.5 kW</p> <p>11.4 kW</p>
Thermal short-time current limited to 10 s	
	400 A
Power loss [W] at AC-3 at 400 V for rated value of the operating current per conductor	
	2.6 W
No-load switching frequency	
<ul style="list-style-type: none"> • at AC 	5 000 1/h
Operating frequency	
<ul style="list-style-type: none"> • at AC-1 maximum • at AC-2 maximum • at AC-3 maximum • at AC-4 maximum 	<p>1 200 1/h</p> <p>600 1/h</p> <p>1 000 1/h</p> <p>300 1/h</p>
Control circuit/ Control:	
Type of voltage of the control supply voltage	
	AC
Control supply voltage at AC	
<ul style="list-style-type: none"> • at 50 Hz rated value • at 60 Hz rated value • rated value 	<p>230 V</p> <p>230 V</p> <p>50 Hz</p>

Control supply voltage frequency 2 rated value	60 Hz
Operating range factor control supply voltage rated value of magnet coil at AC	
• at 50 Hz	0.8 ... 1.1
• at 60 Hz	0.85 ... 1.1
Apparent pick-up power of magnet coil at AC	170 V·A
Inductive power factor with closing power of the coil	0.76
Apparent holding power of magnet coil at AC	15 V·A
Inductive power factor with the holding power of the coil	0.35
Closing delay	
• at AC	10 ... 24 ms
Opening delay	
• at AC	7 ... 20 ms
Arcing time	10 ... 15 ms

Auxiliary circuit:

Number of NC contacts	
• for auxiliary contacts	
— instantaneous contact	0
Number of NO contacts	
• for auxiliary contacts	
— instantaneous contact	0
Operating current at AC-12 maximum	10 A
Operating current at AC-15	
• at 230 V rated value	6 A
• at 400 V rated value	3 A
Operating current at DC-12	
• at 60 V rated value	6 A
• at 110 V rated value	3 A
• at 220 V rated value	1 A
Operating current at DC-13	
• at 24 V rated value	10 A
• at 60 V rated value	2 A
• at 110 V rated value	1 A
• at 220 V rated value	0.3 A
Contact reliability of auxiliary contacts	1 faulty switching per 100 million (17 V, 1 mA)

UL/CSA ratings:

Contact rating of auxiliary contacts according to UL	A600 / Q600
---	-------------

Short-circuit protection

Design of the fuse link	
• for short-circuit protection of the main circuit	

- with type of coordination 1 required
- with type of assignment 2 required
- for short-circuit protection of the auxiliary switch required

fuse gL/gG: 125 A
 fuse gL/gG: 63 A
 fuse gL/gG: 10 A

Installation/ mounting/ dimensions:





Mounting type	screw and snap-on mounting onto 35 mm standard mounting rail according to DIN EN 50022
• Side-by-side mounting	Yes
Height	112 mm
Width	55 mm
Depth	115 mm
Required spacing	
• for grounded parts	
— at the side	6 mm

Connections/ Terminals:

Type of electrical connection	
• for main current circuit	screw-type terminals
• for auxiliary and control current circuit	screw-type terminals
Type of connectable conductor cross-sections	
• for main contacts	
— solid	2x (0.75 ... 16 mm ²)
— stranded	2x (0.75 ... 25 mm ²)
— single or multi-stranded	2x (0,75 ... 16 mm ²)
— finely stranded with core end processing	2x (0.75 ... 16 mm ²)
— finely stranded without core end processing	2x (0.75 ... 16 mm ²)
• at AWG conductors for main contacts	2x (18 ... 2)
Type of connectable conductor cross-sections	
• for auxiliary contacts	
— solid	2x (0.5 ... 1.5 mm ²), 2x (0.75 ... 2.5 mm ²), max. 2x (0.75 ... 4 mm ²)
— finely stranded with core end processing	2x (0.5 ... 1.5 mm ²), 2x (0.75 ... 2.5 mm ²)
• at AWG conductors for auxiliary contacts	2x (20 ... 16), 2x (18 ... 14), 1x 12

Certificates/approvals

General Product Approval				Declaration of Conformity	Test Certificates
 CCC	 CSA	 UL		 EG-Konf.	spezielle Prüfbescheinigungen

Test Certificates	Shipping Approval				
Typprüfbescheinigung/Werkszeugnis	 ABS	 DNV	 GL	 LRS	 RINA

Shipping Approval	other		
 RMRS	Umweltbestätigung	Bestätigungen	sonstig

Further information

Information- and Downloadcenter (Catalogs, Brochures,...)

<http://www.siemens.com/industrial-controls/catalogs>

Industry Mall (Online ordering system)

<https://mall.industry.siemens.com/mall/en/en/Catalog/product?mlfb=3RT10351AL20>

Cax online generator

<http://support.automation.siemens.com/WW/CAXorder/default.aspx?lang=en&mlfb=3RT10351AL20>

Service&Support (Manuals, Certificates, Characteristics, FAQs,...)

<https://support.industry.siemens.com/cs/ww/en/ps/3RT10351AL20>

Image database (product images, 2D dimension drawings, 3D models, device circuit diagrams, EPLAN macros, ...)

http://www.automation.siemens.com/bilddb/cax_de.aspx?mlfb=3RT10351AL20&lang=en

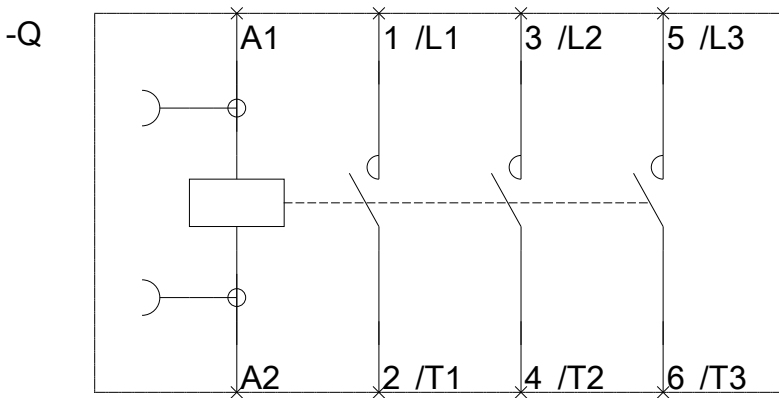
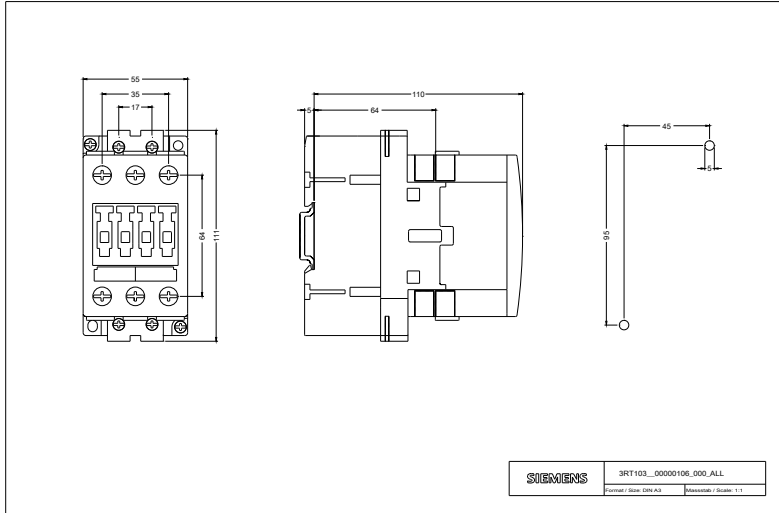

last modified:

12.03.2016