

## DESCRIPTION

VAW DC Multifunction Power Meter provide high accuracy measurement, display and communication of DC voltage, Current, Power, Energy(import / export), and Run Hour. They are also building in 4 Relay outputs, 1 Analogue output, 1 Pulse output , 2 External Control Inputs and 1 RS485(Modbus RTU Mode) interface with versatile functions such as remote I/O, alarm and communication for DC power applications like as solar, wind power system or portable electronic device consumption testing. For the power saving, VAW has built in an innovation timer to switch down the light and power of LED. It makes sense to build the meter in a green power system.



*Power saving function is in patented claim*

## FEATURE

- Measuring DC Voltage, Current, Power, Import Energy and Export Energy
- 4 relay can be multi-cross programmed individual to correspond,
  - ▶ Voltage/Current/Power(kW): Hi / Lo / Hi Latch / Lo Latch energized with Start Delay / Hysteresis / Energized & De-energized Delay functions.
  - ▶ Energy(kWh): Energized with N/R/C mode
  - ▶ Other application: DO(Digital output)
- 2 external control inputs can be programmed individual to correspond,
  - ▶ Voltage/Current/Power(kW): Relative PV (Tare) / PV Hold / Maximum or Minimum Hold
  - ▶ Energy(kWh): Gate / Reset
  - ▶ Other application: DI(remote monitoring) / Reset for Relay Energized Latch
- Analogue multi-cross selection for Voltage/Current/Power(kW)/Energy output in option
- Pulse output to correspond energy and RS 485 communication port in option
- Outside dimensions is DIN standard (96 x 48 mm)
- CE Approved & RoHS

## APPLICATIONS

Solar system monitoring

Testing Equipment

## ORDERING INFORMATION

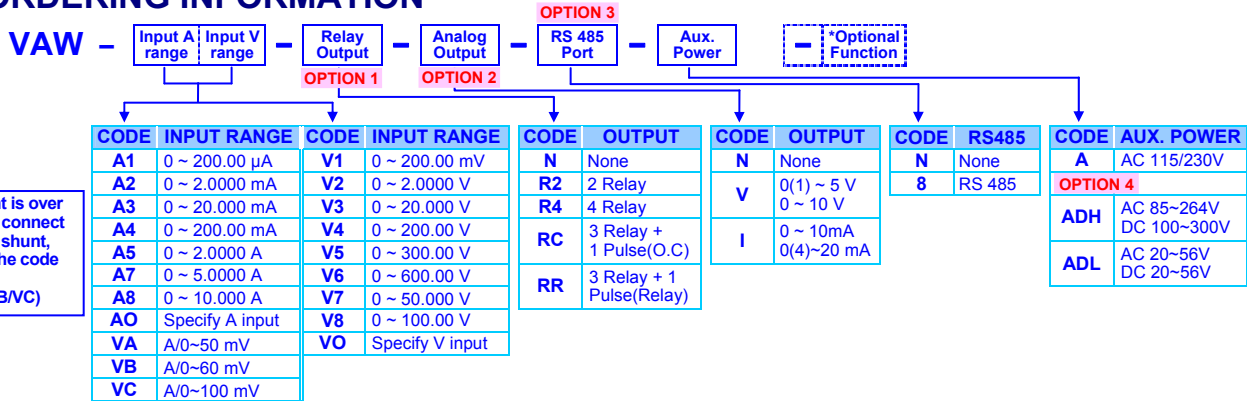

## TECHNICAL SPECIFICATION

### Input Signal

Voltage Measuring Range	Input Impedance	Current Measuring Range	Input Impedance
0 ~ 50 mV/ ~100.000mV	$\geq$ 5M ohm	0 ~ 200.00 $\mu$ A	1K ohm
0 ~ 200.00 mV	$\geq$ 5M ohm	0 ~ 2.0000 mA	100 ohm
0 ~ 2.0000 V	$\geq$ 1M ohm	0 ~ 20.000 mA	10 ohm
0 ~ 20.000 V/~50.000 V	$\geq$ 1M ohm	0 ~ 200.00 mA	1 ohm
0 ~ 100.00 V/~200.00 V	$\geq$ 1M ohm	0 ~ 2.0000 A	0.1 ohm
0 ~ 300.00 V/~600.00 V	$\geq$ 1M ohm	0 ~ 5.0000 A	0.02 ohm
		0 ~ 10.000 A	0.01 ohm

If the input current is over 10A, please connect a Current shunt in the line.

### Accuracy & Resolution

Parameters	Accuracy	Display Range	Resolution
Voltage	0.04% $\pm$ 1digit	-1999~+9999	0.001mV ~ 0.01V
Current	0.04% $\pm$ 1digit	-19999~+99999	0.01 $\mu$ A ~ 0.01A
Power	0.1% $\pm$ 1digit	-19999~+99999	Auto range(KW)

Parameters	Accuracy	Display Range	Resolution
Energy(Import)	0.1% $\pm$ 1digit	0~9999999999	0.0001(kWh)
Energy(Export)	0.1% $\pm$ 1digit	-1999999999~0	0.0001(kWh)
Run Hour	5.256min/year	0~99999999	1 Hr

**Calibration:** Digital calibration by front key  
**A/D converter:** 16 bits resolution  
**Sampling Rate:** 15 cycles/sec  
**Response Time:**  $\leq$ 100 msec.(when the RuG = "1") in standard  
**Max. Input over capability:**  
**Voltage:** 2 x rated continuous;  
 4 x rated for 2 seconds;  
 3 x rated continuous;  
 10 x rated for 10 seconds;  
 50 x rated for 1 second(for 5A input type)  
**Current:**

**Display & Functions**

<b>Numeric LED:</b>	Dual display; 0.28"(7.1mm) high-brightness Up-row for 10 digits red LED down-row for 6 digits green LED
<b>Pages scroll:</b>	5 pages switchable to show all parameters Page 1: Voltage(4 digits), Current(5 digits) and Power Page 2: Voltage(5 digits), Current(4 digits) and Power Page 3: Import Energy and Power Page 4: Export Energy and Power Page 5: Run Hour and Power
<b>I/O Status Indication:</b>	10 square LED <b>Relay energized &amp; Pulse(RL4 specify) indication:</b> 4 square red LED <b>E.C.I. function indication:</b> 2 square green LED <b>RS 485 communication:</b> 1 square orange LED <b>V and A identify &amp; unit:</b> 2 square red LED <b>kWh identify &amp; unit:</b> 1 square red LED
<b>Scaling function:</b>	There are two scaling functions to program individual for two isolation input.
<b>Voltage:</b>	[ <b>uL aS C</b> ] <b>Low Scale:</b> programmable range -1999~+9999 [ <b>uH .S C</b> ] <b>High Scale:</b> programmable range -1999~+9999 [ <b>uP u d P</b> ] <b>Decimal point:</b> programmable from 0 / 0.0 / 0.00 / 0.000
<b>Current:</b>	[ <b>RL aS C</b> ] <b>Low Scale:</b> programmable range -19999~+99999 [ <b>RH .S C</b> ] <b>High Scale:</b> programmable range -19999~+99999 [ <b>RP u d P</b> ] <b>Decimal point:</b> programmable from 0 / 0.0 / 0.00 / 0.000 / 0.0000
<b>Power(kW):</b>	<b>Auto-range display from -19999~±0.0001~99999(kW) according to the multiply between voltage and current. And the decimal point will be decided by the higher resolution between voltage and current.</b>
<b>Over range indication:</b>	[ <b>o u F L</b> ] <b>overflow:</b> when input is over 120% of input range Hi
<b>Under range indication:</b>	[ <b>- o u F L</b> ] <b>overflow:</b> when input is under -120% of input range Lo
<b>Max / Mini recording:</b>	Maximum and Minimum value storage for voltage, Current and Power during power on.
<b>Low cut:</b>	[ <b>L a C t</b> ] <b>Low Cut:</b> Settable range: -19999~29999
<b>Digital fine adjust:</b>	[ <b>P v Z o</b> ] <b>Pv.Zo:</b> Settable range: -19999~+99999 [ <b>P v S n</b> ] <b>Pv.Sn:</b> Settable range: -19999~+99999

**Reading Stable Function**

<b>Average:</b>	[ <b>R u G</b> ]: Settable range: 1~99 times
<b>Moving average:</b>	[ <b>n R u G</b> ]: Settable range: 1(None)~10 times
<b>Digital filter:</b>	[ <b>d F . L t</b> ]: Settable range: 0(None)1~99 times

**Control Functions(option)**

<b>Set-points:</b>	Four set-points Range: Voltage: -1999~+9999 ; Current: -19999~+99999 Power(kW): -19999~+99999 Energy(+kWh): 0~99999999999 Energy(-kWh): -19999999999-0
--------------------	--

<b>Control relay:</b>	Four relays Relay 2 & Relay 3: Dual FORM-C, 1A/230Vac, 3A/115V Relay 1 & Relay 4: Dual FORM-A, 1A/230Vac, 3A/115V
-----------------------	---

<b>Relay energized mode:</b>	Multi-cross programming for all parameters and energized mode.
------------------------------	--

**Corresponds to Current / Voltage / Power(kW)**

<b>Functions:</b>	<b>Energized levels compare with set-points:</b> <b>Hi / Lo / Hi.HLd / Lo.HLd programmable</b> Start delay / Energized & De-energized delay / Hysteresis / Energized Latch <b>Start band</b> (Minimum level for Energizing): 0~9999counts <b>Start delay time:</b> 0:00.0~9(Minutes):59.9(Second) <b>Energized delay time:</b> 0:00.0~9(Minutes):59.9(Second) <b>De-energized delay time:</b> 0:00.0~9(Minutes):59.9(Second) <b>Hysteresis:</b> 0~5000 counts
-------------------	--

**Corresponds to Energy(+kWh / -kWh)**

<b>Functions:</b>	<b>Energized N/R/C mode programmable</b> <b>Energized time:</b> 0:00.0~9(Minutes):59.9(Sec.)
-------------------	---

**DO function:** Energized by RS485 command of master.

**External Control Inputs(ECI)**

<b>Input Mode:</b>	2 ECI points, Contact or open collect input, Level trigger
<b>Functions:</b>	There are flexible functions can be programmed for <b>Corresponds to Current / Voltage / Power(kW)</b> Relative PV / PV Hold / Reset Max or Mini. Hold <b>Corresponds to Energy(+kWh / -kWh)</b> Gate / Reset
<b>DI function monitoring by RS485 command of master.</b>	
<b>Debouncing time:</b>	Settable range 5 ~255 x (8mseconds)

**Analogue output(option)**

<b>Multi-cross function:</b>	User can program the output to correspond <b>Current, Voltage, Power(kW) and Energy(+kWh / -kWh)</b>
<b>Accuracy:</b>	≤ ± 0.1% of F.S.; <b>16 bits DA converter</b>
<b>Ripple:</b>	≤ ± 0.1% of F.S.
<b>Response time:</b>	≤ 100 msec. (10~90% of input)
<b>Isolation:</b>	AC 2.0 KV between input and output
<b>Output range:</b>	Specify either Voltage or Current output in ordering <b>Voltage:</b> 0~5V / 0~10V / 1~5V programmable <b>Current:</b> 0~10mA / 0~20mA / 4~20mA programmable
<b>Output capability:</b>	<b>Voltage:</b> 0~10V: ≥ 1000Ω; <b>Current:</b> 4(0)~20mA: ≤ 600Ω max
<b>Functions:</b>	[ <b>R a H S</b> ] <b>output range high:</b> Settable range: Voltage: -1999~+9999 Current: -19999~+99999 Power(kW): -19999~99999; Energy(+kWh): 0~99999999999 Energy(-kWh): -19999999999-0 [ <b>R a L S</b> ] <b>output range Low:</b> Settable range: Voltage: -1999~+9999 Current: -19999~+99999 Power(kW): -19999~99999; Energy(+kWh): 0~99999999999 Energy(-kWh): -19999999999-0 [ <b>R a L n L</b> ] <b>output High Limit:</b> 0.00~110.00% of output High [ <b>R a P r o</b> ]: Settable range: -38011~+27524 [ <b>R a S P n</b> ]: Settable range: -38011~+27524

**Digital fine adjust:****Pulse output(option)**

<b>Output mode:</b>	Open collect: 30V/60mA or Relay: DC24V/1A (The output frequency has to under 50Hz); Please specify in ordering
<b>Output range:</b>	Maximum frequency: 1000Hz; duty cycle 50%
<b>Pulse divider:</b>	<b>1 Pulse/1~9999 Count programmable.</b>

**RS 485 Communication(optional)**

<b>Protocol:</b>	Modbus RTU mode
<b>Baud Rate:</b>	1200/2400/4800/9600/19200/38400 programmable
<b>Data Bits:</b>	8 bits
<b>Parity:</b>	Even, odd or none (with 1 or 2 stop bit) programmable
<b>Address:</b>	1 ~ 255 programmable
<b>Distance:</b>	1200M
<b>Terminate resistor:</b>	150Ω at last unit.

**Electrical Safety**

<b>Dielectric strength:</b>	AC 2.0 KV for 1 min, Between Power / Input / Output / Case
<b>Insulation resistance:</b>	≥ 100M ohm at 500Vdc, Between Power / Input / Output
<b>Isolation:</b>	Between Power / Input / Relay / Analogue / RS485 / E.C.I.
<b>EMC:</b>	EN 55011:2002; EN 61326:2003
<b>Safety(LVD):</b>	EN 61010-1:2001

**Environmental**

<b>Operating temp.:</b>	0~60 °C
<b>Operating humidity:</b>	20~95 %RH, Non-condensing
<b>Temp. coefficient:</b>	≤ 100 PPM/°C
<b>Storage temp.:</b>	-10~70 °C
<b>Enclosure:</b>	Front panel: IEC 529 (IP52); Housing: IP20
<b>Vibration:</b>	1~800Hz, 3.175g2/Hz

**Mechanical**

**Dimensions:** 96mm(W) x 48mm(H) x 120mm(D)  
**Panel cutout:** 92mm(W) x 44mm(H)  
**Case material:** ABS fire-resistance (UL 94V-0)  
**Mounting:** Panel flush mounting  
**Terminal block:** Plastic NYLON 66 (UL 94V-0)  
 Input 1 / Input 2 / Power : 10A 300Vac, M3.0, 22~12AWG  
 ECI : 5A 300Vac, M2.0, 0.5~1.3mm<sup>2</sup>(22~16AWG)  
 Relay, A/O and RS485: 10A 300Vac, M2.6, 22~16AWG  
 550g / 350g(Aux. Power Code: ADH, ADL)

**Weight:**

**Power**

**Power supply:** AC115/230V,50/60Hz;  
 Optional: AC 85~264V / DC 100~300V  
 or AC/DC 20~56V

**Power consumption:** 5.0VA maximum  
 3.0VA maximum in power saving mode

**Back up memory:** By EEPROM

**■ DIMENSIONS**

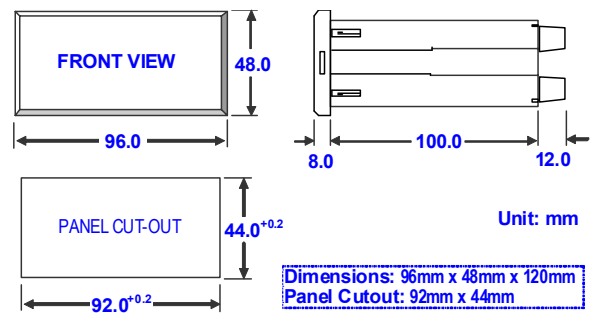

**■ INSTALLATION**

The meter should be installed in a location that dose not exceed the maximum operating temperature and provides good air circulation.

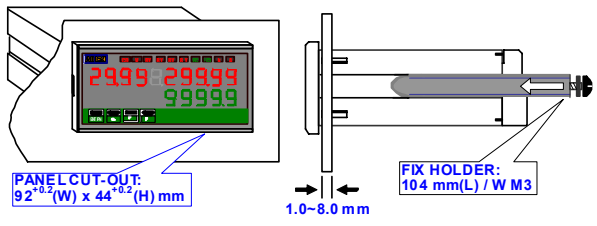

**■ FRONT PANEL**

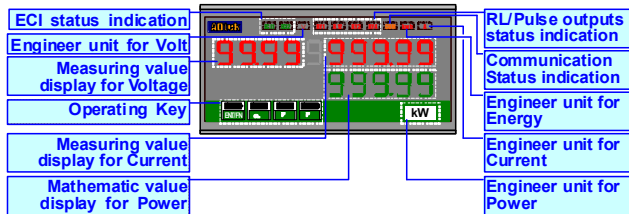

Page 1 for Voltage(4 digits), Current(5 digits) and Power(kW)

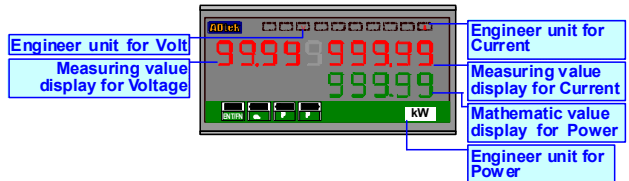

Page 2 for Voltage(5 digits), Current(4 digits) and Power(kW)



Page 3 for Import Energy and Power(kW)

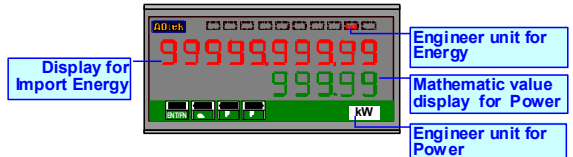

Page 4 for Export Energy and Power(kW)

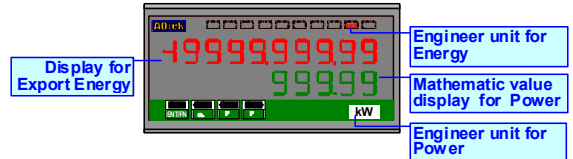

Page 5 for Run Hour and Power(kW)

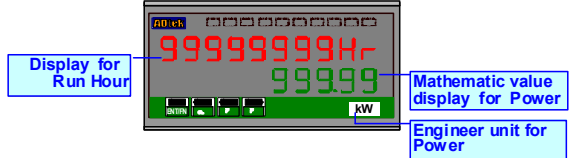

**■ CONNECTION DIAGRAM**

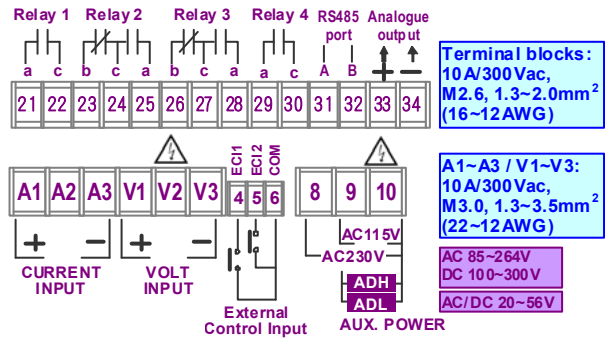

Please check the voltage of power supplied first, and then connect to the specified terminals. It is recommended that power supplied to the meter be protected by a fuse or circuit breaker.

**Power Supply**

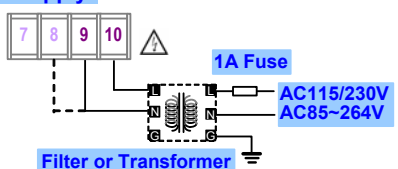

**Input connection**

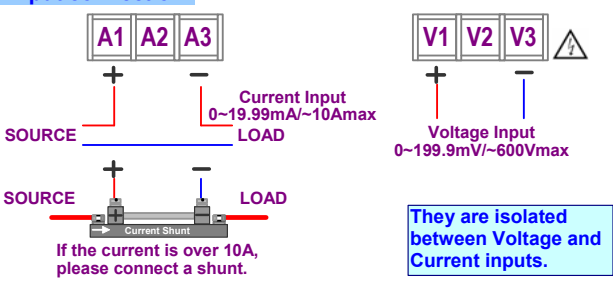

**RS485 Communication Port**

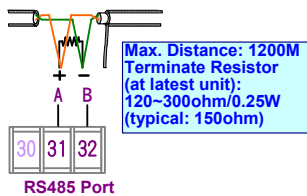

**FUNCTION DESCRIPTION**

**Input & Scaling Functions**

**Scaling function:**

Setting the [L.a5C] (Low scale) and [L.H.5C] (High scale) in [InPtGrp] to corresponding input 1 & input 2 signals. **Reverse scaling will be done too.** Please refer to the figure as below,

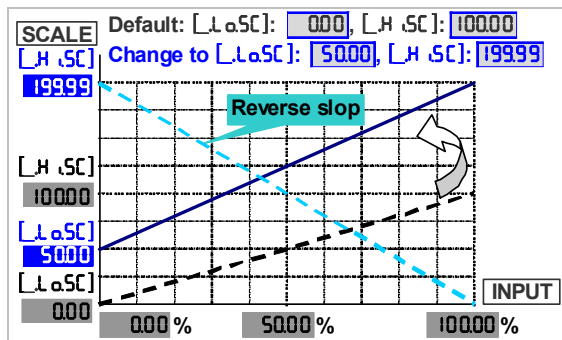

**Display & Functions**

There are dual display screen for all electrical value in VAW. Please refer to the function description as below,

**Display scrolling:**

The dual row display can be scrolled in 5 pages by front Up/Down key to show all electrical value as below,

- Page 1 for Voltage(4 digits), Current(5 digits) and Power(kW)
- Page 2 for Voltage(5 digits), Current(4 digits) and Power(kW)
- Page 3 for Import Energy and Power(kW)
- Page 4 for Export Energy and Power(kW)
- Page 5 for Run Hour and Power(kW)

**Max / Mini recording:**

In order to review & trace the drifting PV, the meters will keep the values of maximum and minimum in [user level] during power on. User can reset the values of Voltage, Current and Active power individually by [rSt] in [user level]. And it'll record new maximum and minimum value immediately after reset.

**PV(Present value) Hold [PuHld]**

When the [EC\_] (External Control input) set to be [PuHld] (PV Hold) function in [ECGrp], that display will be hold & kept, and the relative green LED will be bright, when the ECI terminals been closed or pressed Up/Down Key function been set (the 1<sup>st</sup> times), until the ECI is to be opened or press Up/Down Key again ( the 2<sup>nd</sup> times).

- ▶ Please paste the sticker **ECI PVH** on the right side of green square LED of ECI to identify the status of display.

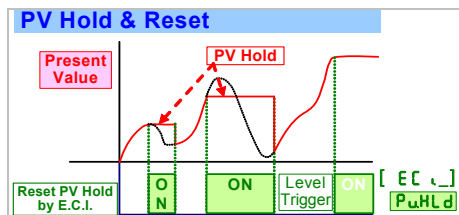

**Relative PV(ΔPV) or Tare [rELPv]**

The [EC\_] can be set to be [rELPv] (Relative PV) function. When the ECI is closed, the reading will show the differential value with PV or Tare either.

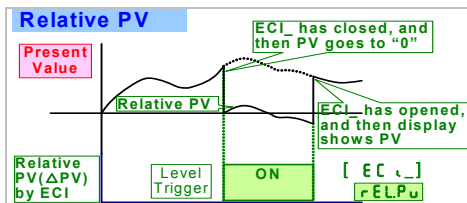

**Low cut:** Settable range from -19999~+99999 counts.

The users can set the value range.

- (1) If set the positive value (X1) here to display "0" which it expressed to be low-cut the PV between "+X1 (plus)" & "-X1 (minus)" /absolute value **PV < | Setting value (X1) |, the display will be shown 0**  
EX: Low Cut is set for 0.50. If the display is from -0.50~+0.50, that will be 0.

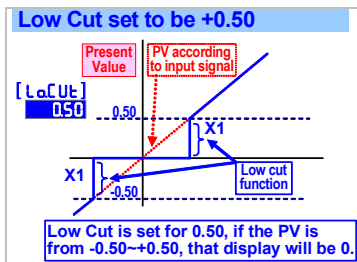

- (2) If set the negative value (X2) here to display "X2" which it expressed to be low-cut the PV that it's under the X2 setting value; **PV < Setting value(X2), the display will be shown X2.**  
EX: Low Cut is set for -0.01. If the display is < -0.01, and all the display will be -0.01.

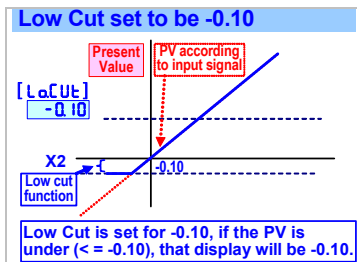

**Digital fine adjust:** Settable range for Current: -19999~+99999  
Voltage: -19999~+99999

Users can get "Fine Adjustment PV" by front key on the meter for lower and/or higher points. "Just Key-In" the value, if user wants to show the value in input signals currently. Especially, the [PuPo] & [PuSn] are not only in zero & span of PV, but also randomly lower point in function [PuPo] & randomly higher point in function [PuSn]. The meter will be auto-linearization for full scale. The adjustment can be cleared in function [P5CL].

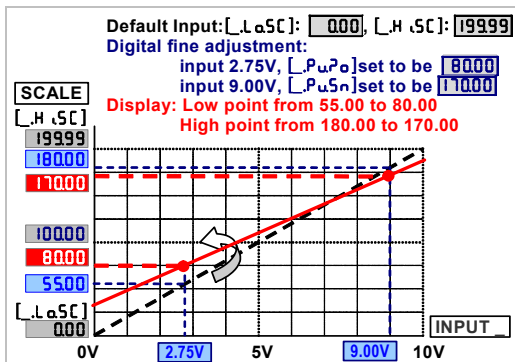

**Reading Stable Function**

**Average display:** Settable range: 1-99 times

Jittery Display caused by the noise or unstable signal. User can set the times to average the readings, and to get smoothly display. The meter's sampling is 15cycle/sec. If the [ **AVG** ](Average) set to be **3** to express the display update with 5 times/sec. The meter will calculate the sampling 1-3 and update the display value. At meantime, the sampling 4-6 will be processed to calculate.

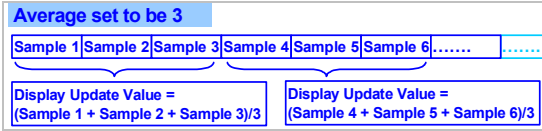

**Moving average display:** Settable range: 0(no function)/1-10 times

Jittery Display caused by the reasons as like as noise or unstable signal. User can set the times to average the readings, and get smoothly display.

The meter's sampling is 15cycle/sec. If the [ **MAVG** ](Moving Average) set to be **3** expressed the display update with 15 times/sec., In the first updated display value will be same as average function. In the next updated display value, the function will get the new fourth sample (sample 4) then throw away the first sample (sample 1) that the newest 3 samples(sample 2,3,4) will be calculated for the updated display value.

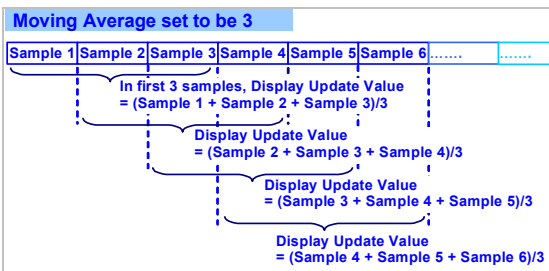

**Digital Filter:** Settable range from 0(None)/1-99 times.

The digital filter can reduce the influence of spark noise caused by magnetic of coil. If the values of samples are over digital filter band(fix in firmware and about 5% of stable reading) 3 times (Digital Filter set to be 3) continuously, the meter will admit the samples and update the new reading. Otherwise, it will be as treat as a noise and skip the samples.

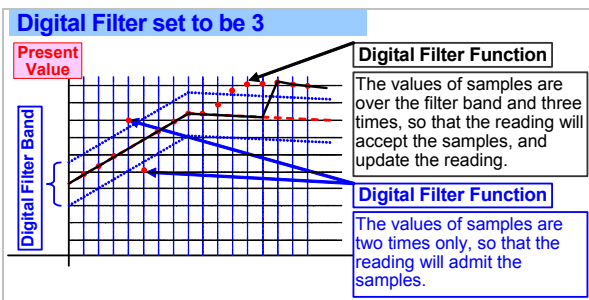

**Relay Functions(option)**

VAW offer the 4 relay outputs with multi-cross functions. User can set the relay functions to correspond Current([ **APU** ]), Voltage([ **uPU** ]), Power([ **PPU** ]), Energy([ **PH** ]) and Energy([ **-PH** ]).They can be programmed individually in [ **RELAY GROUP** ]. If users specify a pulse output, the relay output will be 3 maximum due to the limited terminal. Please refer to the description as following;

**Corresponding to Current([ **APU** ]), Voltage([ **uPU** ]), Power([ **PPU** ])**

**Relay energized mode:** Hi / Lo / Hi.HLD / Lo.HLD / DO

**Hi(Fig.1-①):** Relay will be energized when PV > Set Point

**Lo(Fig.1-②):** Relay will be energized when PV < Set Point

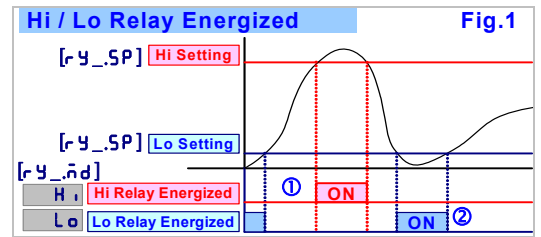

**Hi.HLD (Lo.HLD):**

The relay energized with latched function is for electrical safety and human protection. For example, a current meter relay installed for the over current alarm of motor. Generally, over current of motor caused by over load, mechanical dead lock, aging of insulation and so on. Above cases will alarm in the meter, if the user doesn't figure out the real reason and re-start the motor. It may damage the motor. The functions of Hi.HLD & Lo.HLD are designed must be manual reset the alarm after checking out and solving the issue. It's very important idea for electrical safety and human protection. As the PV Higher (or lower) than set-point, the relay will be energized to latch except manual reset by from key in [ **user level** ] or [ **EC** ](ECI) set to be **4r5t** is closed.

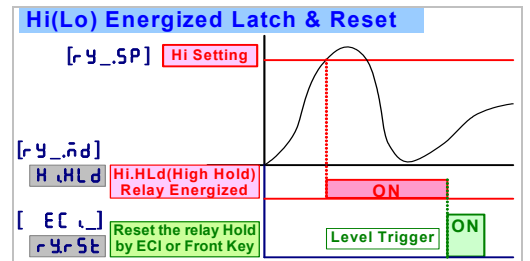

**DO(Digital output):**

The function has been designed not only a meter but also an I/O interface. In the case of motor control cabinet can't get the remote function. It's very easily to get the ON/OFF status of switch from CS2 series with RS485 function. If the [ **Y\_nD** ] had been set **da**, the relay will be energized by RS485 command directly, but no longer to compare with set-point.

**Start delay band and Start delay time:**

- The functions have been designed for,
  - ▶ To avoid starting current of inductive motor (6 times of rated current) with alarm.
  - ▶ If the [ **Y\_nD** ] relay energized mode had been set to be **Lo**(Lo) or **Lo.HLD**(Lo & latch). As the meter is power on and no input to display the "0" caused the relay will be energized. User can set a band and delay time to inhibit the energized of relay.

**Start band(Fig.2-①):** Settable range from 0-9999 Counts

**Start delay time(Fig.2-②):** Settable range from 0.0(s)-9(m)59.9(s);

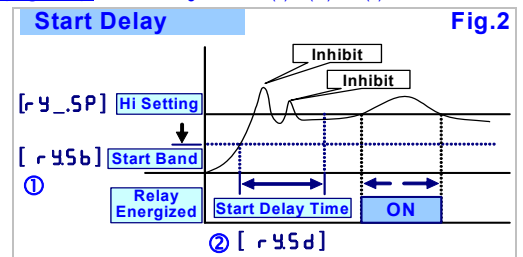

**Hysteresis(Fig.3-①):** Settable range from 0-9999 Counts

As the display value is swing near by the set point to cause the relay on and off frequently. The function is to avoid the relay on and off frequently such as compressor.....etc.,

**Relay energized delay(Fig.3-2):** Settable range from 0.0(s)~9(m)59.9(s);

The function is to avoid the miss action caused by noise. Sometime, the display value will swing caused by spark of contactor...etc.. User can set a period to delay the relay energized.

**Relay de-energized delay(Fig.3-3):** Settable range from 0.0(s)~9(m)59.9(s);

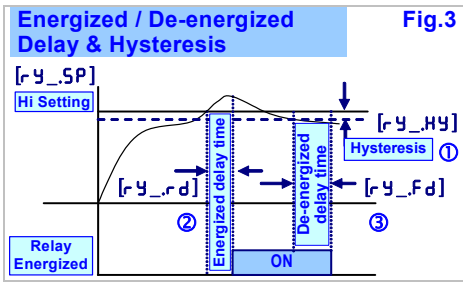

**Corresponding to Energy( PPH)**

For energy(±kWh), The relay output is not only according to relay energized mode, set-point and relay out time but also reset the relay and energy(±kWh). Please refer to the description in following,

**Relay energized mode:** N / C / R mode

**Relay output time:** Settable range from 0.0(s)~9(m)59.9(s)

**N mode:**

- Energy(±kWh) & relay reset by manual
- When the condition of **Set Point** is met:
  - The relay will be energized;
  - The energy(±kWh) will run as same as usual, until manual reset by front key or by ECI of rear terminal, the energy(±kWh) will be reset to "0" and the relay will be de-energized.

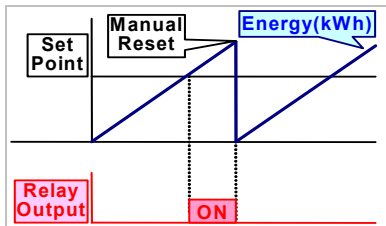

**R mode:**

Energy(±kWh) & relay reset by time setting of relay output time[r\_y\_o\_t]

- When the condition of **Set Point** is met:
  - The relay will be energized, until the time is over Relay output time [r\_y\_o\_t](Relay \_ output times).
  - The energy(±kWh) will run as same as usual; until the time is over Relay output time [r\_y\_o\_t] (Relay \_ output time),The energy(±kWh) will be reset to "0".

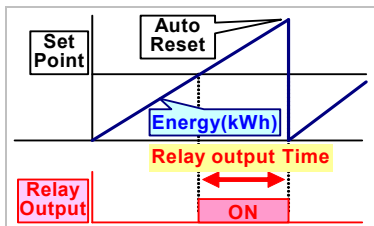

**C mode:**

Energy(±kWh) auto reset & relay reset by time setting of relay output time[r\_y\_o\_t]

- When the condition of **Set Point** is met:
  - The relay will be energized, until the time is over Relay output time [r\_y\_o\_t] (Relay\_ output times).
  - The energy(±kWh) will be reset to "0" immediately, then counts-up from "0".

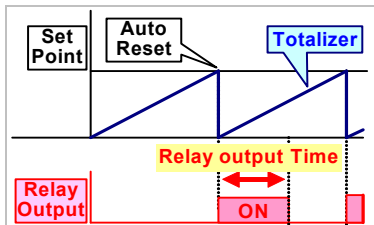

**External Control Inputs(ECI)**

VAW offers 2 point external control inputs (ECI) with Multi-Cross selection function. User can set the ECI functions corresponding to Current( RPu), Voltage( uPu), Power( PpPu), Energy( PPH) and Energy( -PPH). They can be programmed individual with versatile display and control functions. The front key function can be set to execute ECI function. At meantime, ECI terminals will be disabling. The input from terminal has designed level trigger. Please refer to description as below,

**Corresponding to Current( RPu), Voltage( uPu), Power( PpPu) ECI Functions:**

**Relative PV:**

Relative PV / PV Hold / Reset for Maximum or Minimum / DI(Digital Input) / Reset for Relay Energized Latch

The [EC u] can be set to be FELPu(Relative PV) function. When the ECI is closed, the all readings will show the differential value with Current( RPu), Voltage( uPu), Power( PpPu) .

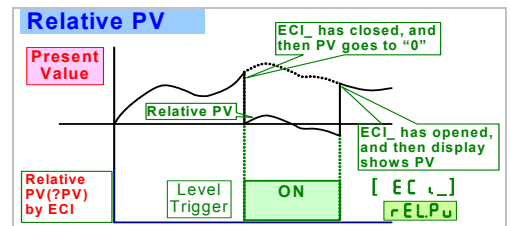

**PV Hold:**

The [EC u] can be set to be PwHLd(PV Hold) function. The display will be hold when the ECI is closed, until the ECI is to be open. Please refer to the below figures,

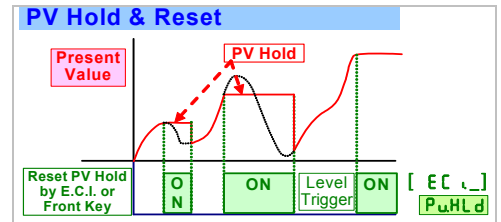

**Reset for Maximum or Minimum:**

The [EC u] function can be set to be r5t function to reset the maximum and minimum value in [User Level] by terminals of ECI.

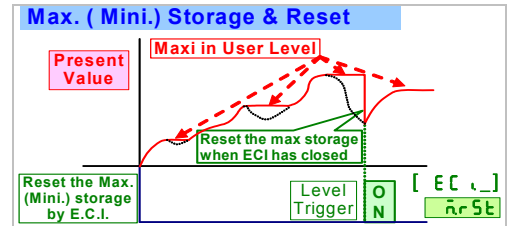

**DI(Digital Input):**

The [EC u] can be set to be d(Digital Input) function, when the meter has been building in RS485 port. The master is easier to get a switch status through the meter as like as DI of PLC.

**Reset for Relay Energized Latch:**

If the relay energized mode has been set to be HHLd(Energized latch), and the [EC u] can be set to be r5t(Reset the Relay energized latch). When the PV meets the condition of relay energizing, the relay will be energized and latch until the ECI is to be closed.

**Corresponding to Energy( PPH)**

**ECI Functions:**

**Gate function:**

Gate / Reset  
Energy(±kWh) will be stopped to accumulate, when ECI is closed, until the ECI open again. The Energy(±kWh) will accumulate continuously after the ECI open.

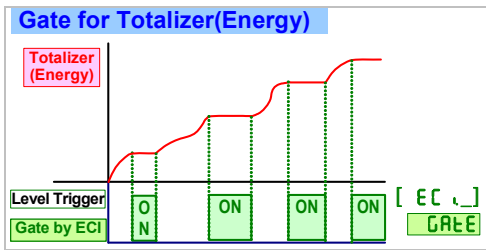

**Reset Function:** Energy( $\pm$ kWh) will be reset to "0", when ECI is closed, until the ECI open again. The Energy( $\pm$ kWh) will accumulate from 0 after the ECI open.

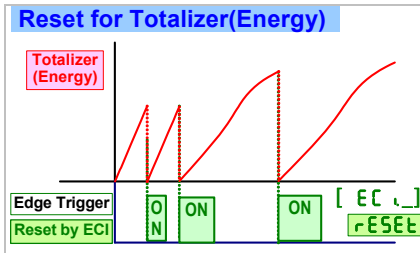

**Debouncing time:** The function is for avoiding noise signal into the meter. And The basic period is 8 mseconds. It means you set the number that has to multiply 8 mseconds. For example: [dEbnc] set to be 5, it means 5 x 8mseconds = 40 mseconds

**Pulse Output(optional)**

The meter offers a pulse output corresponding to energy( $\pm$ kWh). It's a popular application to connection a DI of PLC to manage the power consumption. The pulse output is 1000Hz maximum, and 50% duty cycle(0.5msec. minimum).

**Pulse divider:**

Settable range from 1~9999.  
 ▶ [PLSd] set to be [1]: It will output 1 pulse, when energy( $\pm$ kWh) increases "1Count".  
 Ex: It will output 1 pulse, when energy from 12345.678 increase to 12345.679.  
 ▶ [PLSd] set to be [1000]: It will output 1 pulse, when energy( $\pm$ kWh) increases "1000Count".  
 Ex: It will output 1 pulse, when energy from 12345.678 increase to 12346.678.

**Analogue output(option)**

Please specify the output type either a 0~10V or 4(0)~20mA in ordering. VAW offers one analogue output with Multi-Cross selection function. User can program the output to correspond Current ([RPu]), Voltage([uPu]), Power([PPu]), Energy([EWh]) and Energy([-EWh]), and also the output low and high can be programmable which it's related to various display values easier in [RoGrouP]. Reverse slope output is possible by reversing point positions. Please refer to the detail description as below,

**Output range corresponds to various display values:**

Programmable range:  
 Voltage: -1999~+9999 Current: -19999~+99999  
 Power(kW): -19999~99999;  
 Energy(+kWh): 0~999999999  
 Energy(-kWh): -199999999~0

**Output low corresponds to display Low:**

Setting the Display value Low to versus output range Low(as like as 4mA in [R4-20]).

**Output high corresponds to display High:**

Setting the Display value high to versus output range high(as like as 20mA in [R4-20]).

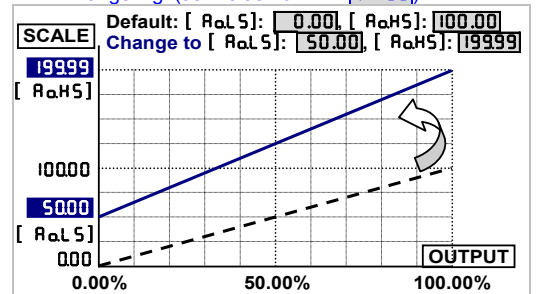

**Fine Zero & Span Adjustment:**

Users can get Fine Adjustment of analogue output by front key on the meter. Please connect standard meter to the terminals of analogue output. To press the front key(up or down key) of meter for adjusting and checking the output.

**Fine Zero Adjustment:** Settable range: -38011~27524;

**Fine Span Adjustment:** Settable range: -38011~27524;

**High Limited:**

Settable range: 0.00~110.00% of output High;  
 User can set the high limit of output to avoid destroying the receiver or protection system.

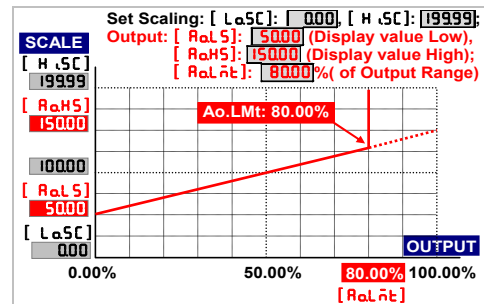

**RS 485 communication(option)**

VAW supports Modbus RTU mode protocol to be used as Remote Terminal Unit (RTU) for monitoring and controlling in a SCADA (Supervisor Control And Data Acquisition) system. The baud rate can be up to 38400 bps. It's not only can be read the measured value and DI (external control inputs) status but also controls the relays output (DO) by RS485 communication ports.

**VAW APPLICATION FOR RS485 WRITING**

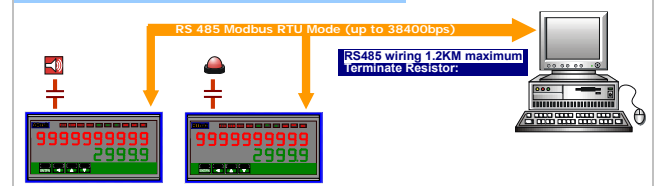

**Power Saving Function**

For the power saving, VAW has built an innovation timer that can be set a time to switch down the light and power of LED. It meets green power idea to build a low consumption meter in a green power system.

**Power Saving Time:** Settable from 0.0~9(M);59.9(S)

The LED will be darker and power consumption will be less, after user didn't push the front key for over the setting of power saving time[PSRUE]. The power consumption will be less than 40% of rated.

## FRONT PANEL:

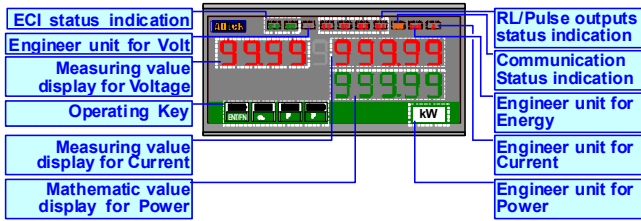

There are two row displays in VAW to show all parameter in 5 pages. The description as below,

### Number screen

- **Up row:** 8.8888888888 : 0.28"(0.71cm) red high-brightness LED
- **Down row:** 8.8888 0.28"(0.71cm) green high-brightness LED
- **Pages scroll:** 5 pages switchable by front / key to show all parameters

The voltage and current display range are 5 digits. There are 4 digits voltage display in page 1 and 4 digits current display in page 2, due to the voltage and current display in 10 digits limited.

Page 1 for Voltage(4 digits display), Current(5 digits) and Power(kW)



Page 2 for Voltage(5 digits), Current(4 digits) and Power(kW)

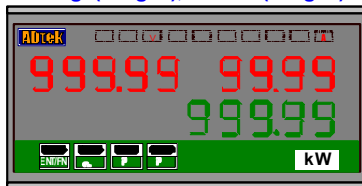

Page 3 for Import Energy and Power(kW)

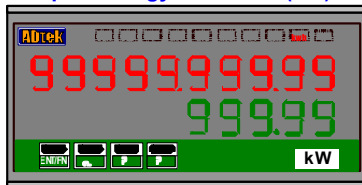

Page 4 for Export Energy and Power(kW)

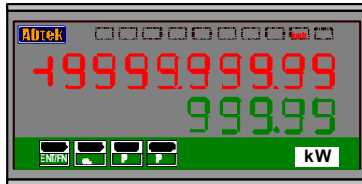

Page 5 for Run Hour and Power(kW)

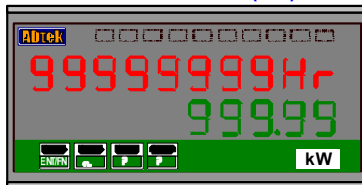

### I/O Status Indication

- **Relay Energized:** 4 square red LED
  - RL1** display when Relay 1 energized;
  - RL2** display when Relay 2 energized;
  - RL3** display when Relay 3 energized;
  - RL4** display when Relay 4 energized;
- **External Control Input Energized:** 2 square green LED
  - EC1** display when E.C.I. 1 close(dry contact)
  - EC2** display when E.C.I. 2 close(dry contact)

- **RS485 Communication:** 1 square orange LED
  - COM** will flash when the meter is receive or send data, and **COM** flash quickly means the data transient quicker.

- **Pulse Output:** 1 square red LED
  - PLS** will flash when the pulse is output according to the accumulation of energy.

### Stickers:

Each meter has a sticker what are functions enclosure.

### Functions stickers

HH	HI	LO	LL	D.L	D.H	DO	D.H	M.H	Tare
GO	Hi.H	Lo.H	R.PV	R.RS	M.RS	PV.H	BK1	BK2	BK3
DI	RST	DO1	DO2	DO3	DO4	DI1	DI2	DI3	

### Relay energized

<b>HH</b>	HH Energized	<b>HI</b>	Hi Energized
<b>LO</b>	Lo Energized	<b>LL</b>	LL Energized
<b>DO</b>	RS485 Energized	<b>Lo.H</b>	Lo Energized & Latch
<b>Hi.H</b>	Hi Energized & Latch		

### ECI functions:

<b>PV.H</b>	PV Hold	<b>R.PV</b>	Relative PV	<b>DI</b>	Digital Input
<b>M.RS</b>	Maximum or Minimum Reset				
<b>R.RS</b>	Reset fo Relay Latch				

- **Operating Key:** 4 keys for Enter(Function) / Shift(Escape) / Up key / Down key

### Pass Code: Settable range:0000~9999;

User must key-in the exactly pass code for access to [Programming Level]. Otherwise, the meter will return to measuring page. If user forgets the pass code, please contact with your service window.

### Function Lock: There are 4 levels programmable.

- **nonE (None):** no lock at all. User can access to all level for checking and setting.
- **USEr (User Level):** User Level lock. User can access to User Level for checking, but can not setting.
- **EnG (Programming Level):** Programming level lock. User can access to programming level for checking, but can not setting.
- **RLl (ALL):** All lock. User can access to all level for checking but can not setting.

### Basic/Advance:

In the programming level, the meter shows only general functions for basic programming in each group. There are advance functions has been hidden in **AdunC** (advance). User can set the **AdunC** in [Prog] of each group to show all functions.



## ■ ERROR MESSAGE

BEFORE POWER ON, PLEASE CHECK THE SPECIFICATION AND CONNECTION AGAIN.

SELF-DIAGNOSIS AND ERROR CODE:

DISPLAY	DESCRIPTION	REMARK
ouFL	Display is positive-overflow (Signal is over display range)	(Please check the input signal)
-ouFL	Display is negative-overflow (Signal is under display range)	(Please check the input signal)
ouFL	ADC is positive-overflow (Signal is higher than input 120%)	(Please check the input signal)
-ouFL	ADC is negative-overflow (Signal is lower than input -120%)	(Please check the input signal)
EEP → FAIL	EEPROM occurs error	(Please send back to manufactory for repaired)
A.i.C.nG → Pu	Calibrating Input Signal do not process	(Please process Calibrating Input Signal)
A.i.C → FAIL	Calibrating Input Signal error	(Please check Calibrating Input Signal)
A.o.C.nG → Pu	Calibrating Output Signal do not process	(Please process Calibrating Output Signal)
A.o.C → FAIL	Calibrating Output Signal error	(Please check Calibrating Output Signal)





















## ■ OPERATING KEY

\*Please access to the Programming Level to check and set the parameters when users start to run the meter

■ Operating Key: 4 keys for  Enter(Function) /  Shift(Escape) /  Up key /  Down key

■ The meter has designed operation similar as PC's   and . In any page, press  key means "enter" or "confirm setting", and press  key means "escape" () or "shift".

■ In Programming Level, the screen will return to Measuring Page after do not press any key over 2 minutes, or press  for 1 second.

	Function Index	Setting Status
 (=  ) <b>Enter/Fun key</b>	(1) In any page, press  to access the level or function index (2) From the function index to access setting status	(3) Setting Confirmed, save to EEPROM and go to next function index
 (=  ) <b>Shift key</b>	(1) In measuring page, press  for 1 second to access user level. (2) In function index, press  for 1 second to go back upper level. (3) In function group index, press  for 1 second to go back measuring page	(4) In setting status, press  to Shift the setting position. (5) In setting status, press  for 1 second to abort setting and go back this function index.
 (=  ) <b>Up key</b>	(1) In function index, press  to go back to previous function index	(2) In setting status for function, press  to select function (3) During number Setting, press  can roll the digit up
 (=  ) <b>Down key</b>	(1) In Function Index Page, press  will go to the next Function Index Page.	(2) In setting status for function, press  to select function (3) During number Setting, press  can roll the digit down.