



**KERN & Sohn GmbH**

Ziegelei 1

D-72336 Balingen

E-Mail: [info@kern-sohn.com](mailto:info@kern-sohn.com)

Phone: +49-[0]7433-9933-0

Fax: +49-[0]7433-9933-149

Internet: [www.kern-sohn.com](http://www.kern-sohn.com)

# Operating manual

## Platform balance

### **KERN IEX**

Version 1.2

10/2014

GB



Doc.No.IEX-BA-e-1412



**KERN IEX**  
Version 1.2 10/2014  
**Operating manual**  
**Platform balance**

---

---

Contents

<b>1</b>	<b>Pay attention to the instructions in the Operation Manual</b> .....	<b>3</b>
<b>2</b>	<b>Intended use of IEX scales</b> .....	<b>4</b>
<b>3</b>	<b>Design of IEX scales with one weighing cell</b> .....	<b>4</b>
<b>4</b>	<b>ATEX marking – meaning of icon</b> .....	<b>6</b>
<b>5</b>	<b>How to install the balance</b> .....	<b>8</b>
<b>6</b>	<b>Changing the installation site of the balance</b> .....	<b>11</b>
<b>7</b>	<b>Cleaning and maintenance</b> .....	<b>12</b>
<b>8</b>	<b>Technical examination</b> .....	<b>13</b>

English

# 1 Pay attention to the instructions in the Operation Manual



Carefully read this operation manual before setup and commissioning, even if you are already familiar with KERN balances.



All language versions contain a non-binding translation.

The original German is binding.

Conformity with the specifications stated in these operating instructions is a precautionary measure for the safe operation of OEX scales in explosion protected spaces.

Employees should familiarize themselves with the device's components described in the operating instructions:

- Display KEX-TM
- Power unit IEX-A01-U, IEX-A01-E

These operating instructions should be freely available for consultation to the employees.

The operating instructions contain the icons shown below:

- Continuously prescribed actions
- Actions prescribed under certain circumstances



- Marking essential paragraphs dealing with explosion protection

These operating instructions may be supplemented by additional warnings and safety information provided by KERN.

All employees must be informed about new supplements added to these operating instructions.

## 2 Intended use of IEX scales

Load in ex-protected spaces. It is possible to tare the balance over the entire working range, thus allowing determination of the net weight.

The design of the balance (construction of non-electrical part of the platform balance and material used) is in conformity with Directive 94/9/EE, applicable in countries of the European Union.



- Due to their design, the balances of the IEX series can be used with a non-electrical part on the platform and the material used in zones 1 and 2 where
  - gasses, mixtures of gasses, vapour types IIA, IIB or IIC
  - or explosive groups can develop,
  - as well as for temperature classes T1, T2, T3 or T4.

## 3 Design of IEX scales with one weighing cell

The construction of balances with one weighing cell of the IEX series is based on the modular design principle and comprise:

- Display KEX-TM
- Power unit IEX-A01 by KERN, outside hazardous area
- Weighing cell executed as ex-model
- Weighing platform, non-electric, mechanical balance component.

The display unit for series KEX-TM is connected by a cable to the dynamometric sensor (one weighing cell) integrated in the platform. The platform balance comprises a weighing pan made of stainless steel providing sufficient protection and allowing easy cleaning. The series IEX comprises an aluminium weighing cell, guaranteeing advanced sturdiness against damaging influences and ambient conditions.

The cable used for connecting the weighing cell to the display unit is protected by a rod or approx. 3 m long tube.

The display unit is supplied with energy by the KERN mains adapter IEX-A01 positioned outside the hazardous area. The mains adapter is plugged into the mains power supply of 230V.

The housing of the display unit has a marked terminal for the PE conductor (electrostatic discharge). The housing is connected electrically to the platform balance by a steel tube.

## Balance series IEX with display unit KEX-TM

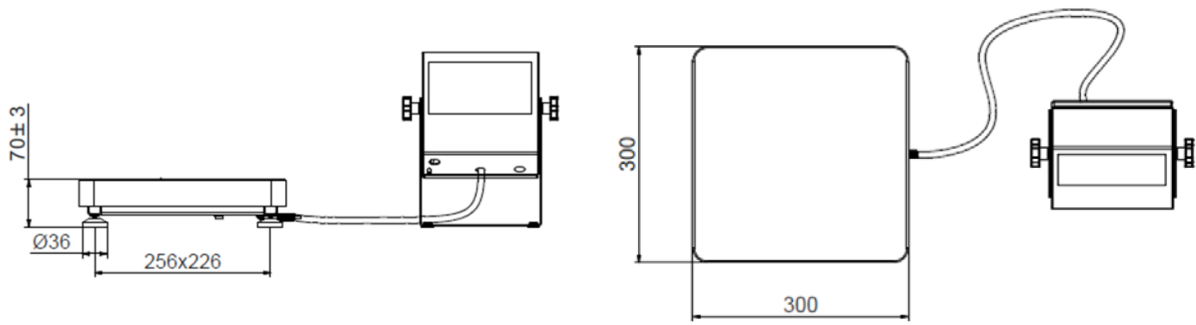
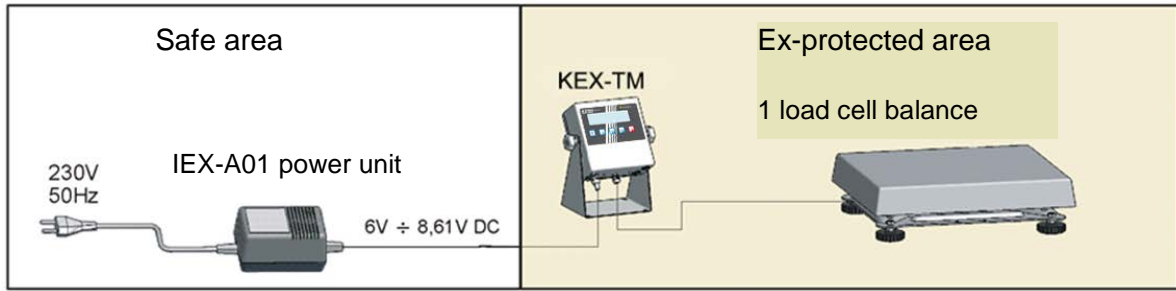

IEX (platform balance 300x300)

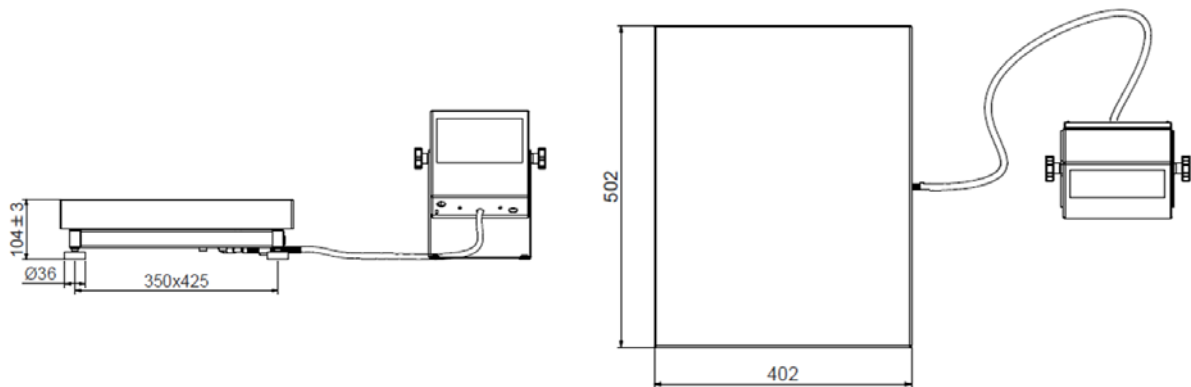

IEX – (500x400)

## 4 ATEX marking – meaning of icon



- IEX balances meet the requirements of group II, class 2 for devices in accordance with Directive 94/9/WE and are marked as - **Ex II 2 G IIB T4**.

### Explanation of icons as per Directive 94/9/WE:

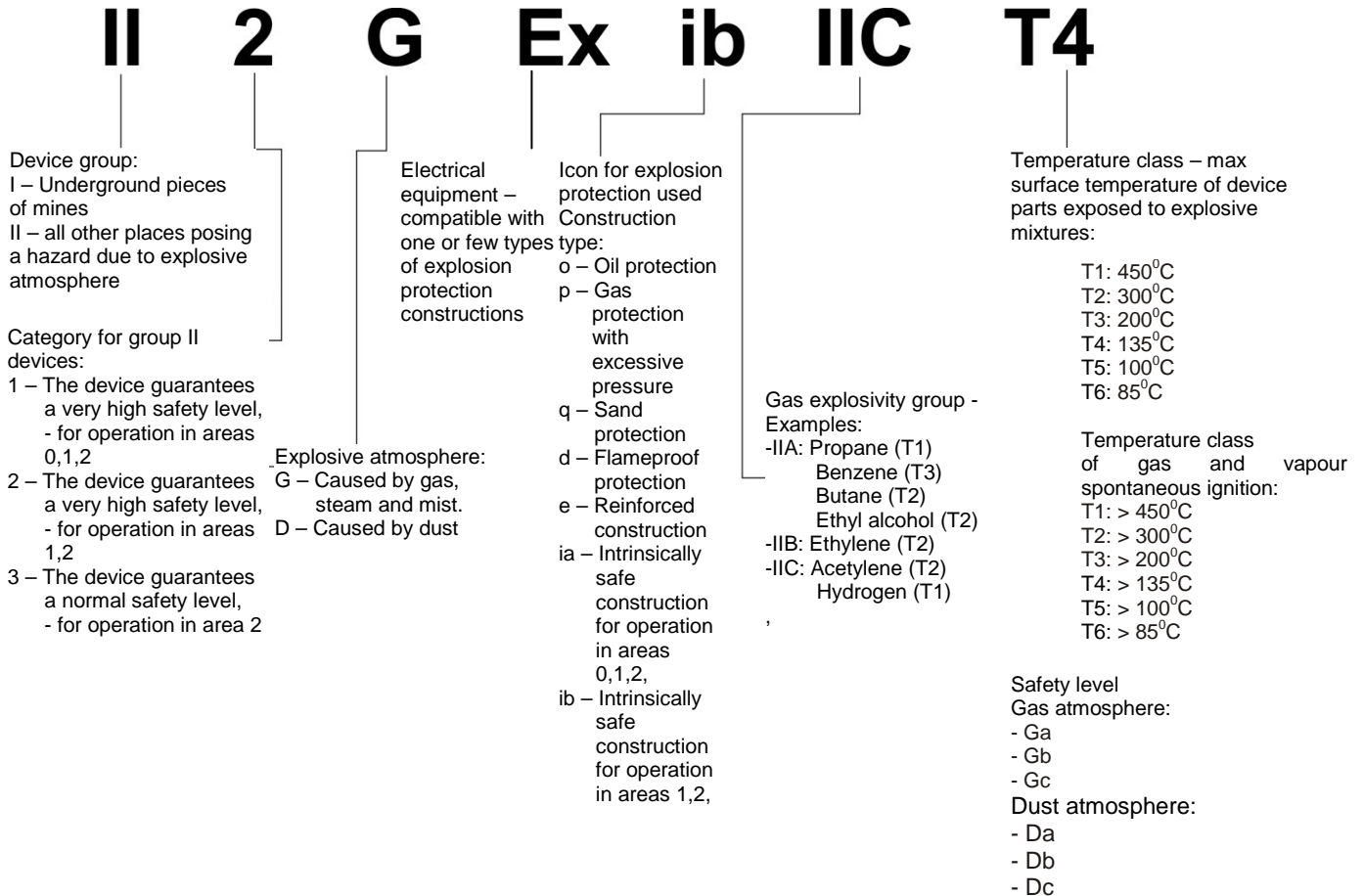

Balance IEX is intended for indoor and outdoor use. However, they should not be exposed to chemical vapours, extreme temperatures or extreme humidity. The platform balance construction is made of soft alloyed steel and the weighing cells are made of aluminium.



- Ambient temperature during operation -10°C to +40°C.
- The balance must be protected against mechanical shocks and vibrations.
- The IEX balance must be installed and operated by technical staff.
- The balance should be serviced from time to time.
- Prevent electrostatic charge. Ensure that the earth conductor is connected to the PE conductor on the display unit KEX-TM at all times.
- Do not disconnect PE conductor. The use of equipotential bonding is only admissible where the development of explosive gasses can be completely ruled out.
- In the case of damage to the balance, pull the power plug, disconnect the supply cable and take the device to a safe place for interim storage so as to prevent any possible use of the balance before repair.
- The display unit KEX-TM is designed intrinsically safe and is in conformity with the following standards: PN-EN 60079-0 and PN-EN 60079-11 certified by KDB 14ATEX0110 certificate.
- The display unit is powered by mains adapter IEX-A01 made by KERN and positioned outside the hazardous and is in conformity with the standards: PN-EN 60079-0 and PN-EN 60079-11, certificate KDB 14ATEX0109.
- The platform balances are equipped with Flintec ATEX certified weighing cells PC22, PC42, PC46, PC60 supplied by Flintec – certificate BSV 09 ATEX E 086X
- All non-electrical parts of the platform balance have been manufactured in accordance with standard PN-EN 13463-1.
- All repair and maintenance work during which the housing of the display unit needs to be opened should be carried out by KERN customer services. Replace subassemblies with genuine parts. The balance must not be opened by unauthorised persons as this will result in loss of all rights to compensation under warranty.

Any installation or repair work deviating from those described in these operating instructions will inevitably result in loss of warranty.

## 5 How to install the balance

- Prepare the installation site for the IEX balance in a professional manner.
- Ensure that the installation site is dry, level and firm.
- The permissible operating temperature range is from -10°C to +40°C
- The floor base for the installation of the platform balance must be firm enough for supporting the maximum weight allowed for the load plus the platform balance.
- The IEX balance has a display unit connected to the platform.
- The display unit is designed for attachment to the table or installation on the wall with the help of a holder.
- The balance should be unpacked outside the hazardous zone.
- Remove all transport locking devices after unpacking:

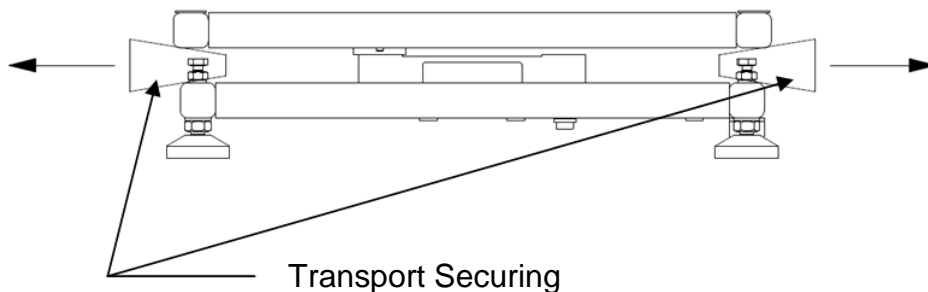

### CAUTION!

- To prevent electrostatic charge, connect the balance to earth.
- The contact slots for the wires are marked with the icon „ $\perp$ “.

- Prior to transport, prepare a PE conductor for electrostatic connection to earth of the display unit.
- The PE conductor should end in a loop that is screwed to the display unit with the help of nuts (M4).
- To ensure that the loop is fixed permanently and in contact with the display unit, use a lock washer.
- The PE conductor should be of yellow and green colour and provide a sectional surface of 4mm<sup>2</sup>.



The diagram below shows the balance's connection to earth:

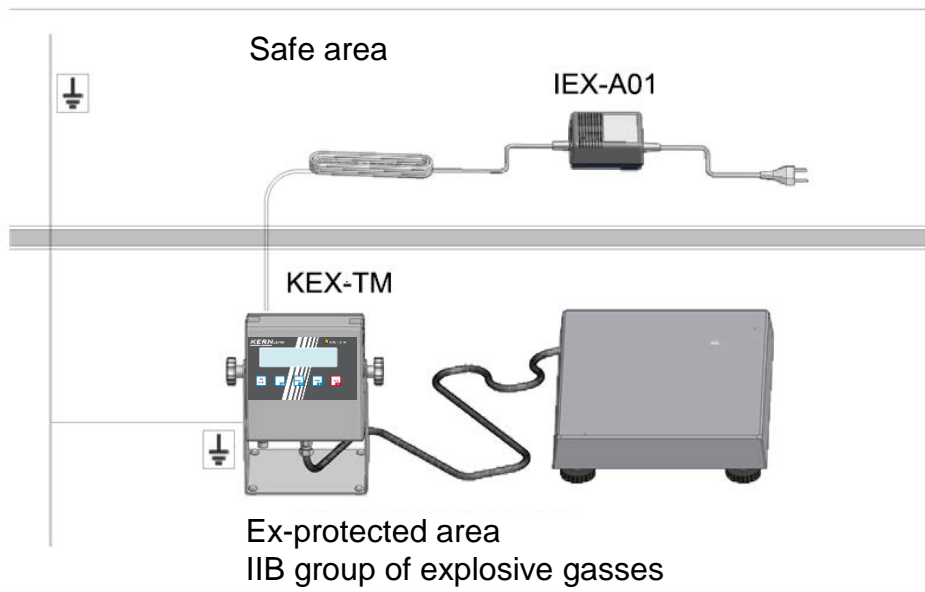

Place the platform balance and the display unit on the intended installation site in the ex-area and connect it to earth.



**CAUTION!**

- **The assembly of the display unit, installation of the platform balance and the connection to earth must be carried out within a time frame that rules out the risk of developing an explosive atmosphere.**

- Place the platform balance in a level, stable place as far away as possible from heat sources and drafts.
- Level the balance with the help of the adjustable feet and a spirit level.
- Check, whether the adjustable feet stand on the balance base.
- Ensure that the weight is evenly distributed among the feet.
- Check once again that the installation site for the balance is level. Exact flatness is established when the air bubble of the spirit level is in the centre of the spirit level ring.

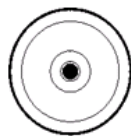

level - OK

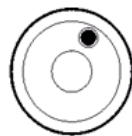

level incorrect

- If further levelling of the platform balance is required, turn the adjustable feet of the balance in order to adjust the height.
- Check the earth contact springs between the platform balance and the weighing pan. This ensures that the electrostatic charge is discharged from the weighing pan.

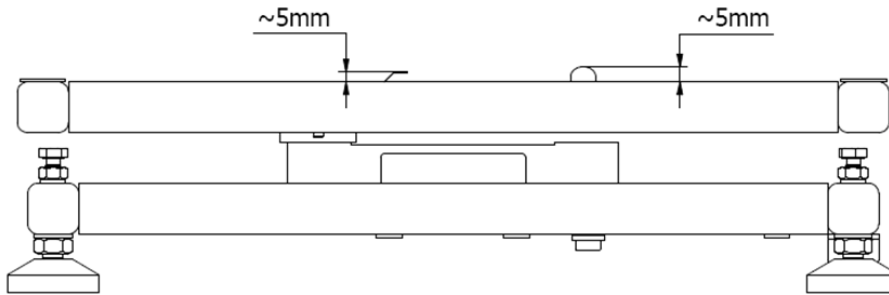

- Put the weighing pan on the platform balance.
- Position the adapter outside the hazardous area in which an explosive atmosphere may be expected to be present (that is in a safe place).
- Connect the connecting cable (max. 20 m) to the mains terminal marked **DC IN** on the display unit.

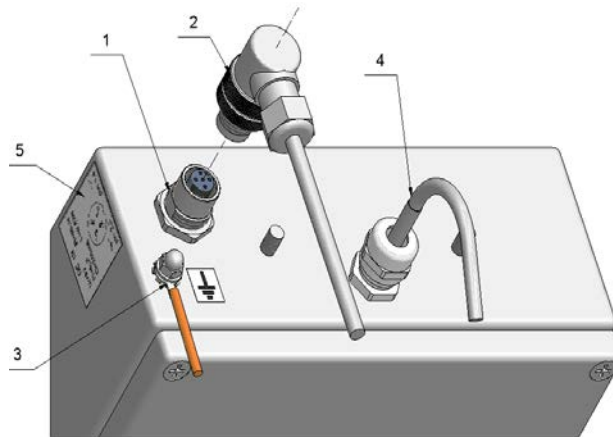



1. Mains connection
2. Connection cable
3. Marking PE conductor
4. Shielded load cell cable
5. Sticker power connection



- Prior to initial start-up ensure that there is no risk of explosion – that is, that no explosive atmosphere is present. If it is obvious that the balance is not functioning properly, disconnect the balance from the power supply, secure it and contact KERN customer services.

- Connect the mains connection to the power supply of 230V AC.
- For prolonged periods of inactivity disconnect the balance from the power supply.
- Press the ON/OFF  button and hold for approx. 1 second.
- After turning on the balance will carry out a self-test.
- Afterwards the balance will change to zero display, thus indicating readiness for operation.
- The following icons will appear:

	Zero indicator
	Stability display
kg	Weighing mode / weighing unit

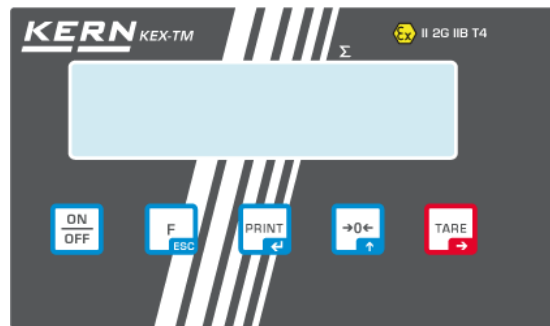

## 6 Changing the installation site of the balance

	<ul style="list-style-type: none"> <li>• When the balance is to be taken to a different installation site please follow the precautionary measures stated under chapter 5 of these operating instruction.</li> </ul>
---	--

## 7 Cleaning and maintenance

- Unplug the mains plug from the power unit IEX-A01.
- Check, whether the electrostatic earth connection is plugged in correctly and make sure it is in good working order.



- Clean the balance and the housing, using a slightly moistened cloth. Simply apply any commercially available cleaning agent available for domestic use.
- Do not use any agents for cleaning that may scratch the surface mechanically. Among other things it is covered in a conductive coat that is important for safe operation.
- The adjustable feet of the platform balance and the shock absorbers are made of rubber. When they are inside the hazard area, you will have to use a slightly moistened cloth for cleaning. Moistness protects against electrostatic charges.
- Make sure that you do not damage the earth contact springs during cleaning. They serve as a retainer of electrostatic charge on the weighing pan. They should be approx. 5 mm above the shock absorbers.
- Do not clean in the presence of explosive gasses.
- The use of concentrated acids, alkaline solutions or alcohols for cleaning purposes is prohibited.
- The same applies to the use of compressed air and high pressure cleaning equipment.

## 8 Technical examination



- Technical examination by expert staff is required every three months.

The examination should include the following:

- Connection to earth quality: The quality of the fastening on the housing and the resistance of the connection - max. 100Ω.
- The quality of the connection between the platform and the display unit (flexible steel tube connecting both subassemblies).
- Damage and loss of a connection is unacceptable.
- The electrical connection between the housing and the platform – the maximum resistance between the weighing pan (put on) should be less than 100Ω.
- Stability and levelling of the balance.