

**3 dB Fixed Attenuator 7/16 Female To 7/16 Female
 Up To 7.5 GHz Rated To 25 Watts With Black
 Aluminum Heatsink Body**

Electrical Specifications*

Description	Min	Typ	Max	Units
Frequency Range	DC		7.5	GHz
Impedance		50		Ohms
Attenuation Value		3 to 3		dB
Input Power			25	Watts
Peak Power			500	Watts
VSWR			1.45:1	

* Values at 25°C, sea level

Specifications by Frequency

Description	F1	F2	F3	F4	F5	Units
Range	DC to 6	6 to 7.5				GHz
Insertion Loss	3					dB
VSWR	1.3:1	1.45:1				
Atten. Accuracy	± 0.5	± 0.75				dB
Max. Input Power	25					Watts

Mechanical Specifications

Temperature

Operating Range -55 to +125 deg C

Size

Length 4.5 in [114.3 mm]

Width 2.41 in [61.21 mm]

Weight 0.8 lbs [362.87 g]

Connectors

Description	Connector 1	Connector 2
Type	7/16 DIN Female	7/16 DIN Female
Contact Material & Plating	Brass, Silver	Brass, Silver
Contact Plating Spec.	Gold	Silver
Outer Conductor Material & Plating		Brass, Silver
Hex Size	11/16 In.	11/16 In.
Body Material & Plating	Brass, Silver	Brass, Silver
Body Plating Spec.	Passivated	

Compliance Certifications (visit www.FairviewMicrowave.com for current document)

Plotted and Other Data

Notes:

- Values at 25 °C, sea level



Features:

- Design: Fixed, Bidirectional Attenuator
- Connector 1: 7/16 DIN Female
- Connector 2: 7/16 DIN Female
- Body Material and Plating: Black Anodized Aluminum Heatsink

Fairview Microwave
 1130 Junction Dr. #100
 Allen, TX 75013
 Tel: 1-800-715-4396 / (972) 649-6678
 Fax: (972) 649-6689
www.fairviewmicrowave.com
sales@fairviewmicrowave.com

3 dB Fixed Attenuator 7/16 Female To 7/16 Female Up To 7.5 GHz Rated To 25 Watts With Black Aluminum Heatsink Body from Fairview Microwave is in-stock and available to ship same-day. All of our RF/microwave products are available off-the-shelf from our ISO 9001:2008 certified facilities in Allen, Texas. Fairview Microwave is RF on-demand.

For additional information on this product, please click the following link: [3 dB Fixed Attenuator 7/16 Female To 7/16 Female Up To 7.5 GHz Rated To 25 Watts With Black Aluminum Heatsink Body SA75DFDF25W-03](#)

URL: <http://www.fairviewmicrowave.com/3db-fixed-attenuator-7-16-female-7-16-female-25-watts-sa75dfdf25w-03-p.aspx>

The information contained in this document is accurate to the best of our knowledge and representative of the part described herein. It may be necessary to make modifications to the part and/or the documentation of the part, in order to implement improvements. Fairview Microwave reserves the right to make such changes as required. Unless otherwise stated, all specifications are nominal. Fairview Microwave does not make any representation or warranty regarding the suitability of the part described herein for any particular purpose, and Fairview Microwave does not assume any liability arising out of the use of any part or documentation.



Add to end of part number	
- yy =	Attenuation
- 03	3 dB
- 06	6 dB
- 10	10 dB
- 20	20 dB
- 30	30 dB
- 40	40 dB
- 50	50 dB
- 60	60 dB

Part Number Configuration		
Part Number	Input Connector	Output Connector
SA18SMSF25W	SMA Male	SMA Female
SA18SFSF25W	SMA Female	SMA Female
SA18NMNF25W	N Male	N Female
SA18NFnF25W	N Female	N Female
SA18TMTF25W	TNC Male	TNC Female
SA18TTF25W	TNC Female	TNC Female
SA75DMDF25W	7/16 Male	7/16 Female
SA75DFDF25W	7/16 Female	7/16 Female

Table of Information	
Connector Type	DIM "A" (REF.)
SMA Male	0.7800
SMA Female	0.6300
TNC Male	0.9600
TNC Female	1.0600
N Female	1.0900
N Male	1.1300
7/16 Male	1.2800
7/16 Female	1.3200

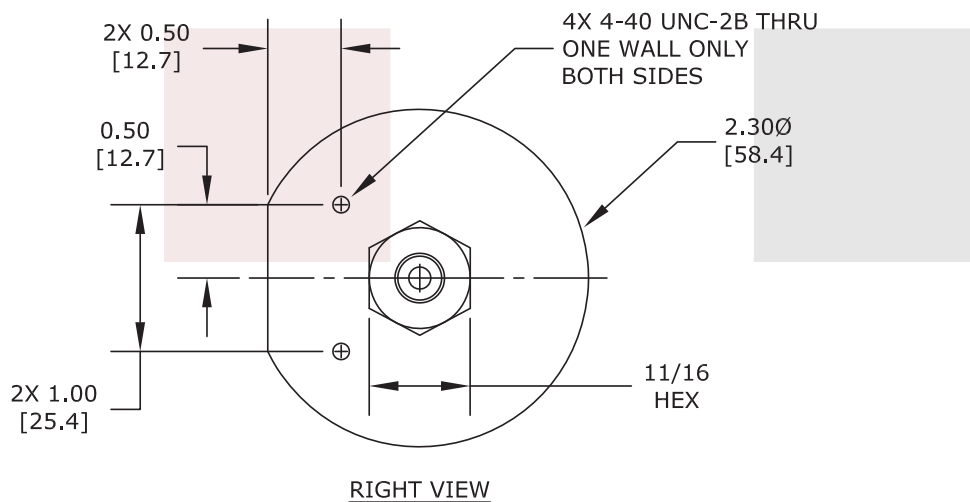
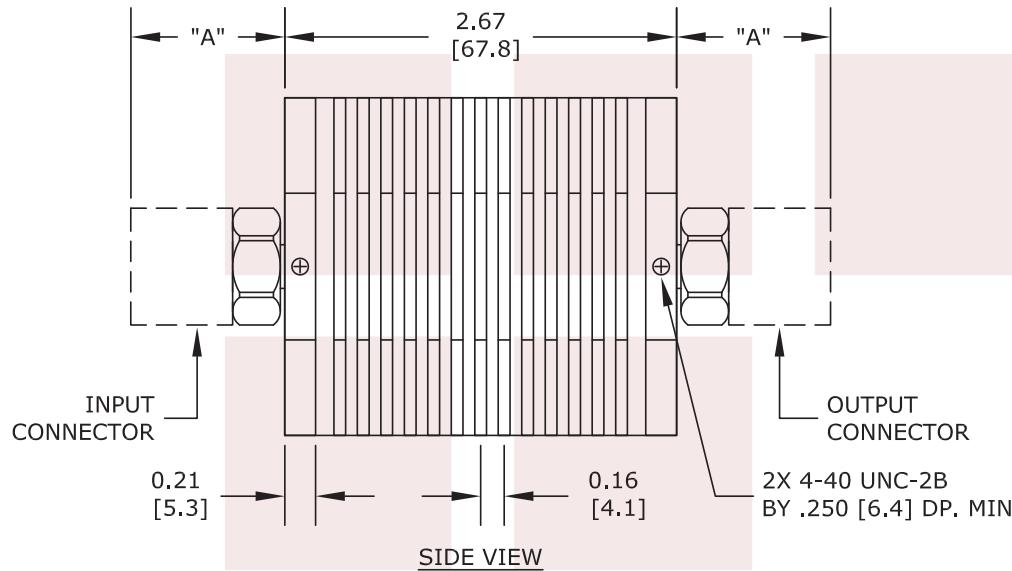

FAIRVIEW MICROWAVE INC. ALLEN, TX 75013 WWW.FAIRVIEWMICROWAVE.COM		NOTES: 1. UNLESS OTHERWISE SPECIFIED ALL DIMENSIONS ARE NOMINAL. 2. ALL SPECIFICATIONS ARE SUBJECT TO CHANGE WITHOUT NOTICE AT ANY TIME. 3. DIMENSIONS ARE IN INCHES [mm].			
TITLE 3 dB Fixed Attenuator 7/16 Female To 7/16 Female Up To 7.5 GHz Rated To 25 Watts With Black Aluminum Heatsink Body	DWG NO SA18XXXX25w-yy	CAGE CODE 3FKR5			
CAD FILE 063014	SHEET	SCALE N/A	SIZE A	2233	