



Operation Manual

Cylindrical Vacuum Desiccators

Models: VDP-25(G/U/UG) and VDP-30(G/U/UG)

Manual No.: D3011L002, Version: 0.0

Table of Contents

1	Safety Advice	1
1.1	Operation Manual.....	1
1.2	DANGER/CAUTION/NOTICE Alerts	1
1.3	Danger Alerts	1
1.4	Caution Alerts	2
2	Product Description	3
2.1	Introduction	3
2.2	Characteristics.....	4
2.3	Components	6
3	Unpacking and Installation.....	8
3.1	Checking Shipment Damage and Unpacking.....	8
3.2	Checking the Contents of the Package.....	8
3.3	Installation	9
3.3.1	Installation Environment.....	9
3.3.2	Installation location	9
4	Operation.....	10
4.1	Precautions.....	10
4.2	Operation of the 3-way Valve.....	10
4.3	Vacuum Formation	11
5	Maintenance	12
6	Troubleshooting.....	13
7	Accessories.....	14
8	Appendix.....	15
8.1	Technical Specifications.....	15
8.2	Disposal of the Unit.....	16
8.3	Warranty and Disclaimer	16
8.4	After-sales Service and Customer Assistance	17

1 Safety



1.1 Operation Manual

This manual contains important safety and operation information. You must carefully read, understand, and follow all the instructions in this manual prior to operating this instrument. Keep this manual in a safe place nearby for reference and make it easily available to all users.

1.2 DANGER/CAUTION/NOTICE Alerts

This manual highlights DANGER/CAUTION/NOTICE alerts to prevent injury or property damage and also to achieve optimum performance of your instrument.

These alerts are classified into three types in this manual depending on the importance and the risk levels as described below:

Symbols	Meaning
	Ignoring this alert could cause serious or even fatal injury.
	Ignoring this alert could cause serious injury or property damage.
	Ignoring this alert could cause operational problems.

Ensure to read the danger and caution alerts in 1.3 and 1.4 carefully before use.

1.3 Danger Alerts

Ignoring the following warnings could cause serious or even fatal injury..

- ◆ Never install or use this unit in explosive atmospheres.
- ◆ Never install this unit near to hazardous or flammable substances.
- ◆ Never disassemble, repair, or modify this unit on your own. Doing so will void your warranty and may result in injuries or product damages.

1.4 Caution Alerts

 CAUTION
Ignoring the following cautions could cause serious injury or property damage.

- ◆ Carefully read all the warning labels before using this unit. And do not remove or damage the warning labels.
- ◆ Do not move this unit during operation.
- ◆ Do not use this unit in wet or moist atmosphere or where water leakage is expected.
- ◆ Do not use this unit in contaminated atmosphere or where metallic dust exists.
- ◆ Do not expose this unit to any heat sources including direct sunlight.
- ◆ Do not allow moisture, organic solvent, dust, or corrosive gases to get into this unit.
- ◆ If you observe a strange smoke, odor or noise from this unit, stop using it. After the smoke or odor disappears, contact your dealer or Jeio Tech if any repair is required.
- ◆ Do not use chlorine bleach, ammonia-based cleaners, abrasives, ammonia, or metal scouring pads. Wipe with a soft damp cloth or a sponge soaked in water or diluted neutral detergent.

2 Product Description

2.1 Introduction

Congratulations of your purchase of our high-quality cylindrical vacuum desiccator which is specially designed to provide maximum benefit for your investment with respect to performance, safety, ease of use, and durability.

Currently eight cylindrical vacuum desiccator models of are available from Jeio Tech: **VDP-25, VDP-25G, VDP-25U, VDP-25UG, VDP-30, VDP-30G, VDP-30U, and VDP-30UG.**

Note that the models with a **G** designation (i.e., VDP-25**G**/25**UG**/30**G**/30**UG**) come standard with a vacuum gauge while the models with a **U** designation (i.e., VDP-25**U**/25**UG**/30**U**/30**UG**) are UV blocking models. These UV blocking models are offered to minimize damages or discoloration of light-sensitive samples by using UV-blocking resin which completely blocks all ranges of UV and the blue spectrum of the visible light.

Being lightweight and yet shatter-resistant, Jeio Tech's cylindrical vacuum desiccators are safer and economical alternatives to conventional glass desiccators for both vacuum and non-vacuum applications.

The vacuum environment created by these desiccators provides a very low humidity, contamination-free, corrosion-free, and dust-free condition which is ideal for:

- ◆ storing moisture-sensitive materials such as anhydrides and other hygroscopic compounds as well as materials which are highly reactive with atmosphere,
- ◆ removing residual solvents or air bubbles,
- ◆ cultivating anaerobic microbes,
- ◆ minimizing the reabsorption of humidity and the exposure to air during the drying or the cooling stages of biological/medical/food/materials experiments,
- ◆ conducting experiments at low pressure,
- ◆ drying at low pressure to minimize the heat effects.

2.2 Characteristics

(1) Outstanding Vacuum Sustainment

This unit maintains a 1 Torr (133 Pa) vacuum for over 72 hours at room temperature and stays gastight allowing reliable experiments over extended periods.

(2) Molded Polycarbonate Body and Base

The body and the base of this unit are made of shock-resistant, highly tensile, and transparent polycarbonate to provide extreme durability as well as convenient visual observation from outside.

The body is molded as a single piece requiring no adhesive and, therefore, allows virtually no leakage.

(3) Viton® 3-way Valve

This unit comes standard with a leak-proof Viton® 3-way valve offering consistent and uniform vacuum draw, vacuum release, or gas exchange without the inconvenience of connecting and disconnecting pump hoses to the unit.

If needed, an additional 3-way valve can be attached to the port at the base.

(4) Locker

This unit is equipped with a locker which allows tight sealing for both vacuum and non-vacuum applications. In addition, this locker provides additional convenience and safety when moving the unit.

(5) Wide Range of Models

Currently eight different models of are available: VDP-25, VDP-25G, VDP-25U, VDP-25UG, VDP-30, VDP-30G, VDP-30U, and VDP-30UG.

These models come in two different capacities to suit the user's needs with the internal volume of either 16 liter (for VDP-25 models) or 25 liter (for VDP-30 models).

The models with a **G** designation (i.e., VDP-25**G**/25**UG**/30**G**/30**UG**) come standard with a vacuum gauge while the models with a **U** designation (i.e., VDP-25**U**/25**UG**/30**U**/30**UG**) are UV blocking models.

(6) Easy Vacuum Level Checking

With a vacuum gauge installed on top of the body, the vacuum level checking can be done conveniently for the models equipped with a vacuum gauge (VDP-25**G**/25**UG**/30**G**/30**UG**).

(7) UV Blocking

These UV blocking models (VDP-25**U**/25**UG**/30**U**/30**UG**) are offered to minimize damages or discoloration of light-sensitive samples by using UV-blocking resin which completely blocks all ranges of UV and the blue spectrum of the visible light.

(8) High Quality Vacuum Seal

The silicone vacuum seal ensures reliable vacuum formation and sustainment without using any grease. For easy cleaning and maintenance, the vacuum seal is specially designed to fit snugly into the bottom groove of the body.

(9) Non-slip Feet

Stable installation of the unit is provided by the four non-slip feet.

(10) Compatibility with VDR Models

VDP models are designed to be compatible with VDR models. Therefore, the bodies or the bases of these models with the same diameters can be mix-and-matched with each other to suit your various needs.

2.3 Components

[VDP-30G Model]

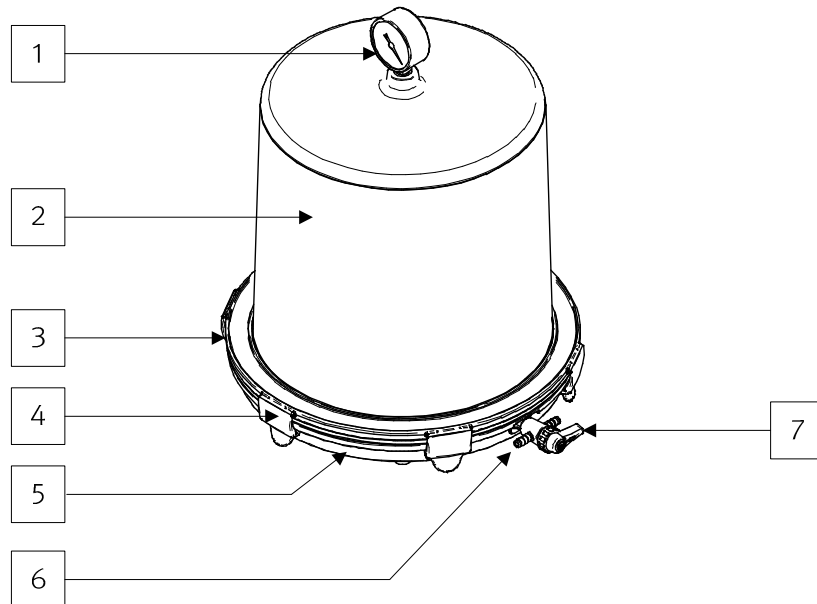

1. Vacuum Gauge
2. Body
3. Vacuum Seal
4. Locker
5. Base
6. Air Inlet/Outlet Nozzle
7. 3-way Valve

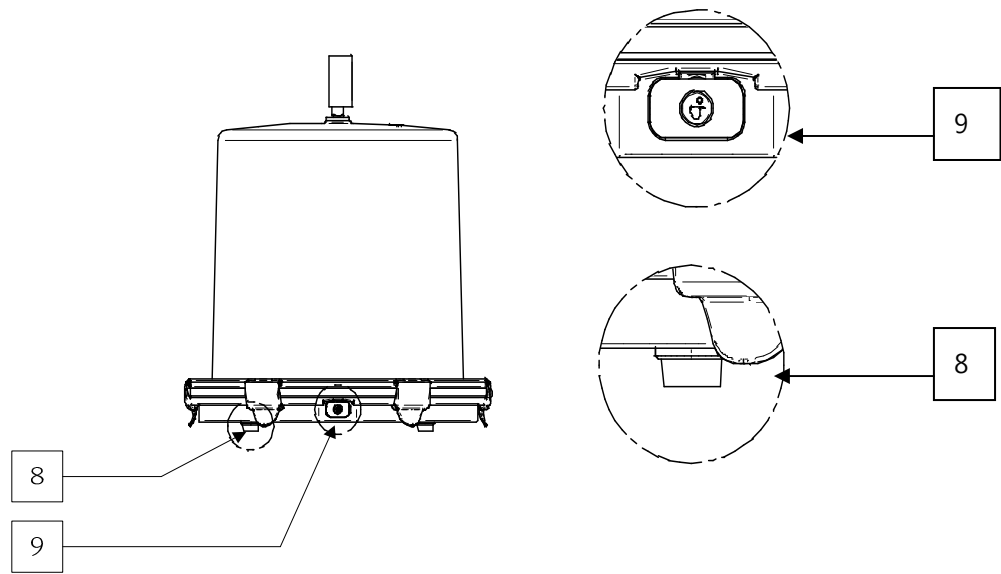

- 8. Non-Slip Feet
- 9. Port Plug





3 Unpacking and Installation

3.1 Checking Shipment Damage and Unpacking

Upon receiving the instrument, check to ensure that no damage has occurred during shipment. It is important that any damage that occurred during shipment is detected before unpacking. If you find such damage, the carrier must be notified immediately.

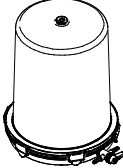
3.2 Checking the Contents of the Package

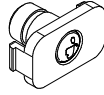
After unpacking, check to ensure that all the parts and accessories described below are included in the package. If not, contact your dealer immediately.

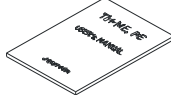
Item	Figure	Quantity
Body		1
3-way Valve		1
Vacuum Gauge		1
Port Plug		1
Vacuum seal		1
Locker		1
Operation Manual		1

3.3 Installation

3.3.1 Installation Environment

NOTICE
Avoid exposure to any heat sources including direct sunlight.

This unit is designed for indoor use in laboratory environments. The conditions for proper installation are as follows:

Permissible Ambient temperature	5 to 40°C (41 to 104°F)
Permissible Relative humidity	below 80%
Permissible Altitude	0 to 2,000 m (6,562 ft)

3.3.2 Installation location

NOTICE
<ul style="list-style-type: none">● Install the unit on a level surface.● Install this unit at least 30 cm away from other equipments.

4 Operation

4.1 Precautions

⚠ CAUTION	
<ul style="list-style-type: none"> ● Do not form a vacuum when airtight containers are inside the unit. ● Note that this unit cannot be autoclaved. ● When attaching an additional 3-way valve or some other equipment after removing the port plug, use a proper O-ring for tight sealing. ● When putting high-temperature samples inside the unit, cool them thoroughly in advance or make sure that they are not in direct contact with the interior of the unit to avoid interior damage. 	

4.2 Operation of the 3-way Valve

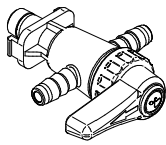
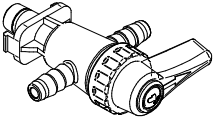
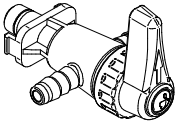
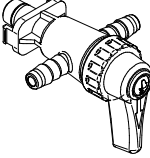
ITEM	Front Nozzle	Rear Nozzle
 <p style="text-align: right;">Rear</p> <p style="text-align: left;">Front</p>	Open	Closed
	Closed	Open
 	Closed	Closed

4.3 Vacuum Formation

The procedures for vacuum formation are as follows:

- (1) Connect the vacuum pump hose to one of the two nozzles of the 3-way valve.
- (2) After activating the vacuum pump, turn the valve handle towards the nozzle to open it and read the vacuum gauge to check whether the vacuum is forming properly.
- (3) When the desired vacuum level is achieved, turn the valve handle until it is perpendicular to the nozzle to close it and check the vacuum gauge whether there is any leakage.
- (4) When releasing the vacuum, slowly turn the valve handle towards the opposite nozzle to return to the normal pressure.

CAUTION

- Do not impact or drop the unit when a vacuum is formed inside.
- When forming or releasing a vacuum, turn the valve handle slowly to avoid rapid pressure change. If not, the stored samples can be damaged or dispersed.
- When forming a vacuum, install a cold trap in front of the vacuum pump. Moisture and chemicals from the samples may result in damages to the pump.
- Do not let the body of the unit into direct contact with acetone, benzene, toluene, chloroform, cresol, sodium hydroxide, highly concentrated nitric or sulfuric acid, acetic acids, or strong chlorine-based solvents.
- Ensure that the vacuum seal is not damaged by strong acid or base. Damaged seal can cause malfunction of the unit.
- When a vacuum is formed inside the unit, do not apply excessive force to the 3-way valves, the vacuum gauge, or any of their vicinities. Any damages caused by external forces can cause malfunction of the unit.
- When the unit is not forming a vacuum, keep the valve handle perpendicular to the nozzles.
- When relocating the unit, do not hold on to protruded parts such as the vacuum gauge or 3-way valves.

5 Maintenance

CAUTION

- If the unit is contaminated, wear chemicals-resistant gloves before cleaning.
- Regularly check the 3-way valves, the vacuum gauge, or any of their vicinities for any damage.
- Regularly check the vacuum seal as well as the surface where the body and the base are in contact and keep them always clean and undamaged.
- Make sure to clean the vacuum seal regularly using diluted neutral detergent. For thorough cleaning, detach the seal from the door.
- Do not use chlorine bleach, ammonia-based cleaners, abrasives, organic solvents, or metal scouring pads when cleaning. Use a soft cloth all the time.

6 Troubleshooting

Problem	Cause	Corrective Action
Vacuum Malfunction	Contaminated surface between the body and the base	Thoroughly clean the surface with a soft cloth using diluted neutral detergent.
	Damaged vacuum seal	Replace the seal.
	Unsuitable room temperature	Check the temperature whether it is within the operating range.
	Misplaced or damaged 3-way valve	Check whether the valve is properly set. If damaged, replace it with a new one.
	Damaged vacuum gauge	Replace the gauge.

7 Accessories

Component	Cat. No.	Description	
Vacuum Gauge	EDA4300	0 to -0.1 (Mpa)	
Vacuum Seal	AAAD1502	VDP-25 (G,U,UG)	Silicone Rubber, Ø283 x 6.5
	AAAD1503	VDP-30 (G,U,UG)	Silicone Rubber, Ø356 x 7.5
Locker	AAAD1512	VDP-25 (G,U,UG)	PP, Ø308 x 43
	AAAD1513	VDP-30 (G,U,UG)	PP, Ø387 x 57
3-way Valve	AAAD4501	PP, Ø9.5 x 18	

8 Appendix

8.1 Technical Specifications

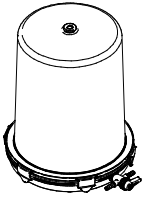
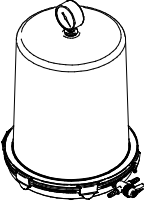
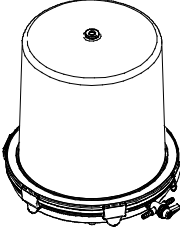
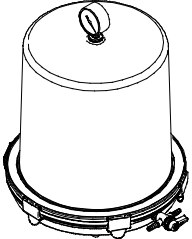
		VDP-25/25U	VDP-25G/25GU	VDP-30/30U	VDP-30G/30GU
					
Internal volume (L)		16		24.9	
Vacuum	Gauge range (Analog, MPa)	N/A	0 ~ -0.1	N/A	0 ~ -0.1
	Max. Permissible	1.33 x 10 ⁻⁴ Mpa (1 Torr)			
	Nozzle diameter (mm)	Ø 9.5			
Material	Jar/Base	Polycarbonate			
	Locker	Polypropylene			
	Vacuum seal, Foot	Silicone Rubber			
Dimension	Overall (Ø x H, mm)	308 x 374	308 x 449	387 x 384	387 x 459
	Internal (Ø x H, mm)	244 x 318		305 x 322	
Net weight (kg)		2.7	2.85	4	4.15

Model	VDP-25U/25UG	VDP-30U/30UG
Color	Amber	
UV Protection (Range)	100% UV A/B/C (200~450 nm)	

8.2 Disposal of the Unit

Disposing of the unit must be done in an environmentally responsible way if it has been potentially exposed to bio-agents or radioactive samples. Failure to follow stringent requirements for appropriate disposal may lead to actions against you and your organization.

- (1) First, check with your laboratory or organization to ensure that you are following all the policies and procedures for disposal of laboratory equipments and wastes.
- (2) If not possible, contact your local governing body for regulations regarding disposal of laboratory equipments. Jeio Tech highly recommends you to find a local service provider that can properly dispose of your unit.

8.3 Warranty and Disclaimer

Jeio Tech warrants to the original consumer that the products it manufactures will be free of defects and perform as specified for a period of two year from the purchase date if the unit was used according to the instructions in this operation manual and only with accessories or consumable parts approved by Jeio Tech.

Any of Jeio Tech's products which, under normal operating conditions, proves defective in material or in workmanship, within two year from the purchase date will be repaired or replaced free of charge.

Our warranty excludes accessories or consumable parts and does not apply to faults resulting from abuse, misuse, alteration, insufficient care, maintenance contrary to the instructions in this operation manual.

Warranty claims can be processed faster if the unit's serial number, detailed description of the problem, and its operating conditions are provided. Consumers will be required to submit the original receipt as proof of purchase date to support a warranty claim.

JEIO TECH HEREBY DISCLAIMS ALL OTHER WARRANTIES, WHETHER WRITTEN OR ORAL, EXPRESS OR IMPLIED BY LAW OR OTHERWISE, INCLUDING WITHOUT LIMITATION, ANY WARRANTIES OF MERCHANTABILITY OR FITNESS FOR ANY PARTICULAR PURPOSE.

CUSTOMER'S SOLE REMEDY FOR ANY DEFECTIVE PRODUCT WILL BE AS STATED ABOVE,

AND IN NO EVENT WILL JEIO TECH BE LIABLE FOR INCIDENTAL, CONSEQUENTIAL, SPECIAL OR INDIRECT DAMAGES IN CONNECTION WITH THE PRODUCT.

8.4 After-sales Service and Customer Assistance

Our after-sales service responds to your questions concerning maintenance and repair of your unit as well as spare parts. In case of a warranty claim, repair or purchase of replacement parts or in case of queries or other problems, please contact your local dealer or Jeio Tech representative.

➤ **International Sales Head Office (Korea)**

#1005, Byucksan Digital Valley 6-Cha, 481-4 Gasan-Dong, Geumcheon-Gu, Seoul 153-704, Korea

Tel: +82 2 2627 3816 **E-mail:** overseas@jeiotech.com **FAX:** +82 2 3143 1824

➤ **The Americas (U.S.A. Branch)**

1-A Gill St. Woburn, MA 01801, U.S.A.

Tel: +1 781 376 0700 **E-mail:** info@jeiotech.com **FAX:** +1 781 376 0704

➤ **Europe (U.K. Branch)**

Unit 3, Tower Industrial Park, Chalgrove, Oxfordshire, OX44 7XZ, United Kingdom

Tel: +44 1865 400321 **E-mail:** labcompanion@medlinescientific.com

FAX: +44 1865 400736

➤ **China (Shanghai Branch)**

A-2113 Oriental International Plaza, 85 LouShanGuan Rd, Changning District, Shanghai, China 200336

Tel: +86 21 3251 1086 **E-mail:** longjuncao@jeiotech.com

FAX: +86 21 3251 1083

➤ **South East Asia (Malaysia Branch)**

No.7A, Jalan Kemboja 1 B/2, 48300 Bandar Bukit Beruntung, Selangor Darul Dhsan, Malaysia

Tel: +60 3 6028 5833 **E-mail:** labcomp@streamyx.com **FAX:** +60 3 6028 5822

◇ The contents of this manual can be changed or upgraded without prior notice.
◇ The copyright of this manual is reserved by Jeio Tech.