



Manual Shield Box

Operating Manual

R121030

<http://www.tescom.co.kr>

SPECIFICATIONS SUBJECT TO CHANGE WITHOUT PRIOR NOTICE

Information contained in this document is subject to change without notice.

Copyright © 2012 Tescom Co., Ltd. Suite #927, Unitechvil 142, Ilsan-ro, Ilsandong-gu, Goyang-si, Gyunggi-do, Korea.

Connects

General Information	9
1.1 WARRANTY	10
1.2 Safety Considerations.....	10
1.3 Safety Symbols and Terms	11
1.4 Instructions and Key Features	11
1.5 Specifications	11
1.6 Initial Inspection.....	12
1.7 Shield Box Connectors	12
Shield Box Connectors.....	12
1.8 Storage.....	13
1.9 Optional I/O Panel and Accessories.....	13
1.10 Service and Support	13
Operation	15
2.1 Component Identification	16
TC-5910D Component Identification.....	16
TC-5915A Component Identification	16
TC-5916A Component Identification	17
TC-5920A Component Identification	17
TC-5922A Component Identification	17
TC-5930A/AR Component Identification	18
Changing the opening direction of the door	18

TC-5972A/C Component Identification	19
TC-5970B/C Component Identification	19
2.2 Maintenance	20
2.3 Performance Test	21
Calibration Period: <6 months	21
Test Subject: Shielding Effectiveness	21
Required Equipment	21
Test Connection	21
Specification	22
TEST Procedure	22
APPENDICES	24
Appendix A	25
TC-5910D Specification	25
TC-5915A Specification	25
TC-5916A Specification	26
TC-5920A Specification	26
TC-5922A Specification	27
TC-5930A/AR Specification	27
TC-5972A/C Specification	28
TC-5970B/C Specification	29
Appendix B	30
TC-5910D Accessories list	30
TC-5915A Accessories list	30

TC-5916A Accessories list	30
TC-5920A Accessories list	30
TC-5922A Accessories list	31
TC-5930A/AR Accessories list	31
TC-5972A/C Accessories list.....	31
TC-5970B/C Accessories list.....	32
Appendix C.....	32
TC-5910D Optional I/O Interface Panel	32
TC-5915A Optional I/O Interface Panel	33
TC-5916A Optional I/O Interface Panel	34
TC-5920A Optional I/O Interface Panel	34
TC-5922A Optional I/O Interface Panel	35
TC-5930A/AR Optional I/O Interface Panel	36
TC-5972A/C Optional I/O Interface Panel.....	37
TC-5970B/C Optional I/O Interface Panel.....	38

Figure Connects

[Figure 1] TC-5910D Component Identification	16
[Figure 2] TC-5915A Component Identification	16
[Figure 3] TC-5916A Component Identification	17
[Figure 4] TC-5920A Component Identification	17
[Figure 5] TC-5922A Component Identification	17
[Figure 6] TC-5930A/AR Component Identification	18
[Figure 7] Changing the opening direction of the door	18
[Figure 8] TC-5972A/C Component Identification	19
[Figure 9] TC-5970B/C Component Identification	19
[Figure 10] Shield Box(ex : TC-5970C)	20
[Figure 11] Shielding Measurement Test Set Up (ex : TC-5970C)	21
[Figure 12] Spectrum Analyzer Display	22

Table Connects

[Table 1] Shield Box Connectors	12
[Table 2] TC-5910D Accessories list	30
[Table 3] TC-5915A Accessories list	30
[Table 4] TC-5916A Accessories list	30
[Table 5] TC-5920A Accessories list	30
[Table 6] TC-5922A Accessories list	31

[Table 7] TC-5930A/AR Accessories list.....	31
[Table 8] TC-5972A/C Accessories list.....	31
[Table 9] TC-5970B/C Accessories list.....	32
[Table 10] TC-5910D I/O Interface Panel.....	32
[Table 11] TC-5915A I/O Interface Panel.....	33
[Table 12] TC-5916A I/O Interface Panel.....	34
[Table 13] TC-5920A I/O Interface Panel.....	34
[Table 14] TC-5922A I/O Interface Panel.....	35
[Table 15] TC-5930A/AR I/O Interface Panel.....	36
[Table 16] TC-5972A/C I/O Interface Panel.....	37
[Table 17] TC-5970B/C I/O Interface Panel.....	38

Chapter

1

General Information

This chapter has general information about warranty, cautions, specifications and key features of a shield box.

1.1 WARRANTY

TESCOM guarantees that this product will be free from defects in materials and workmanship for a period of six months from the date of shipment. During the warranty period, TESCOM will, at its discretion, either repair or replace defective products.

For the warranty service, customer must notify TESCOM of the defect before the expiration of the warranty period and make suitable arrangements for the performance of service. Customer shall be responsible for packaging and shipping the defective product to TESCOM or a service center designated by TESCOM. Customer shall pay for shipping charges as well as any other charges incurred outside of Korea. TESCOM shall pay shipping charge to return the product to customer.

This warranty shall not apply to consumable parts and any failure or damage caused by improper use or unauthorized service. In such cases, TESCOM may refuse to furnish service under the warranty.

LIMITATION OF WARRANTY

The foregoing warranty shall not apply to defects resulting from improper or inadequate maintenance by customer, Customer-supplied software or interfacing, unauthorized modification or misuse, accident or abnormal conditions of operations.

TESCOM responsibility to repair or replace defective products is the sole and exclusive remedy provided to the customer for breach of this warranty. TESCOM will not be liable for any indirect, special, incidental, or consequential damages, despite any advance notice of the possibility of such damages.

1.2 Safety Considerations

Review the following safety precautions to avoid injury and prevent damage to this product or any product connected to it.

Do Not Disassemble any part except replaceable parts

Do Not Operate in Wet/Damp Conditions

To avoid injury or fire hazard, do not operate this product in wet or damp conditions.

Do Not Operate in Explosive Atmosphere

To avoid injury or fire hazard, do not operate this product in an explosive atmosphere.

Provided Proper Ventilation

To prevent product overheating, provide proper ventilation.

Do Not Operate With Suspected Failures

If there is damage to this product, have it inspected by qualified service personnel

Environmental Conditions

Refrain from using this equipment in a place subject to much vibration, direct sunlight, and where the

surface is not level. Also, use it where the temperature is between 0 °C to 50 °C and relative humidity is less than 85 %.

1.3 Safety Symbols and Terms

Terms in this manual:

WARNING: Identifies conditions or practices that could result in injury or loss of life.

CAUTION: Identifies conditions or practices that could result in damage to the product or other property.

Terms on the product:

DANGER: Indicates an injury hazard immediately accessible as you read the marking.

WARNING: Indicates an injury hazard not immediately accessible as you read the marking.

CAUTION: Indicates a hazard to property including the product.

1.4 Instructions and Key Features

TESCOM Shield Box provides RF isolation and signal connections necessary for mobile testing. Shield Box makes an ideal solution for testing mobiles and large RF devices on the test benches of R&D, service, and QC. This low cost quality device is the results of many years of experience in RF test fixture design and will become another standard bench top device for every RF engineer.

- 1) High RF shielding
- 2) Easy Opening/Closing of Door
- 3) EMI filters on all Data and DC lines
- 4) Customizable Data and RF connections
- 5) Shock Absorber on lid

1.5 Specifications

Specifications are listed in Appendix A

1.6 Initial Inspection

This section provides the information for verifying proper shipment of the Shield Box.

Product Condition and Accessory Check

- 1) Upon receipt of the Shield Box, check for damage that could have occurred during shipment.
- 2) Verify you have received the accessories supplied with the Shield Box and Panel, which are listed in Appendix B.



To avoid hazardous electrical shock, do not perform electrical tests when there are signs of shipping damage to the equipment.

1.7 Shield Box Connectors

Shield Box Connectors

This section contains reference information for Shield Box connectors.

[Table 1] Shield Box Connectors

Connectors	Specification
N Coaxial Connector of the outside (Connected to SMA connector of the inside)	Impedance: 50 ohm Voltage Rating: 250 Vpeak Dielectric Withstanding Voltage: 750 Vrms
SMA Coaxial Connector	Impedance: 50 ohm Voltage Rating: 250 Vpeak Dielectric Withstanding Voltage: 750 Vrms
DB9 Data Connector	Working Voltage: 100 VDC Dielectric Withstanding Voltage: 300 VDC EMI Filter: 1000 pF Pi
DB25 Data Connector	Working Voltage: 100 VDC Dielectric Withstanding Voltage: 300 VDC EMI Filter: 1000 pF Pi
DB37 Data Connector	Working Voltage: 100 VDC Dielectric Withstanding Voltage: 300 VDC EMI Filter: 1000 pF Pi
USB2.0 Connector	Data Rate : 480 Mbps

1.8 Storage

The storage temperature range for this equipment is $-20\text{ }^{\circ}\text{C}$ to $70\text{ }^{\circ}\text{C}$. When this equipment is not used for a long period of time, cover with vinyl or place in a cardboard box and store in a dry place away from direct sunlight.

1.9 Optional I/O Panel and Accessories

Optional I/O Panel and Accessories are listed in Appendix C

1.10 Service and Support

If you have a problem with your TC-5970C, contact Tescom Technical Support specialists. Any adjustment or repair of this product must be performed by qualified personnel.

Contact Information

Address: TESCOM Company Limited

#927 Unitechvil 142, Ilsan-ro, Ilsandong-gu, Goyang-si, Gyeonggi-do, Korea [410-722]

TEL: 82-31-920-6601

FAX: 82-31-920-6607

Email: tescom-sales@tescom.org,

Internet: <http://www.tescom.co.kr>

Chapter

2

Operation

This chapter introduces component identifications, operations, maintenance, and performance tests of a shield box.

2.1 Component Identification

TC-5910D Component Identification

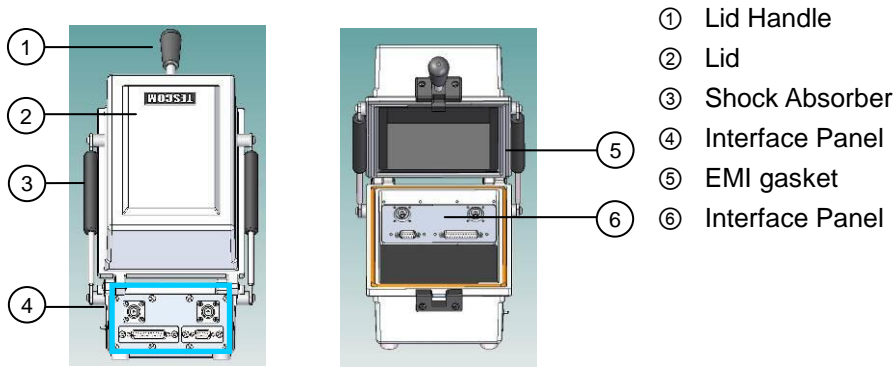

[Figure 1] TC-5910D Component Identification

TC-5915A Component Identification

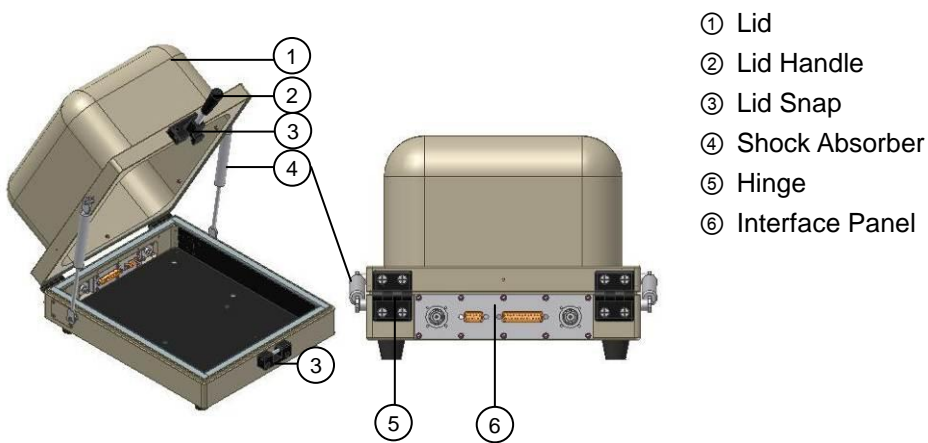

[Figure 2] TC-5915A Component Identification

TC-5916A Component Identification

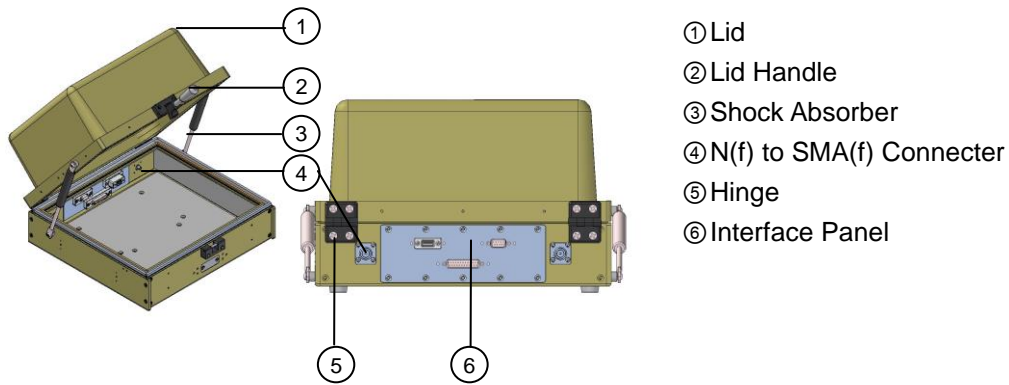

[Figure 3] TC-5916A Component Identification

TC-5920A Component Identification

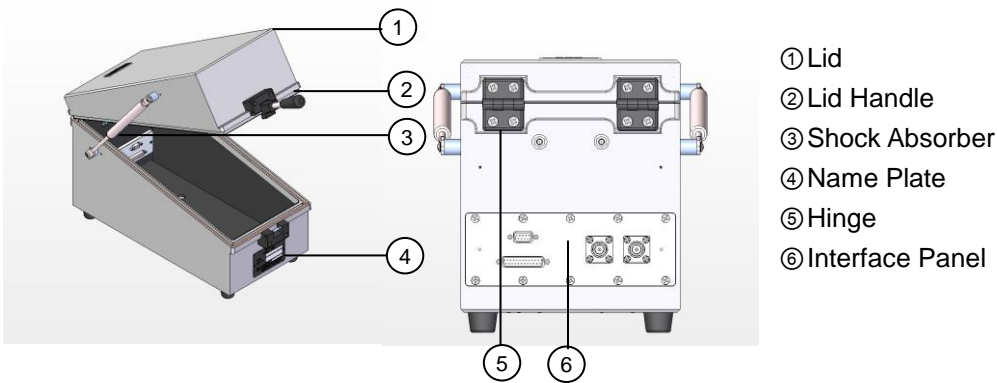

[Figure 4] TC-5920A Component Identification

TC-5922A Component Identification

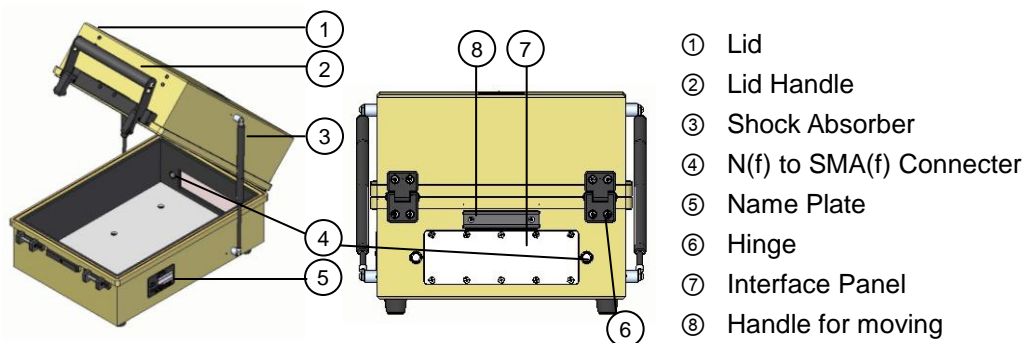

[Figure 5] TC-5922A Component Identification

TC-5930A/AR Component Identification

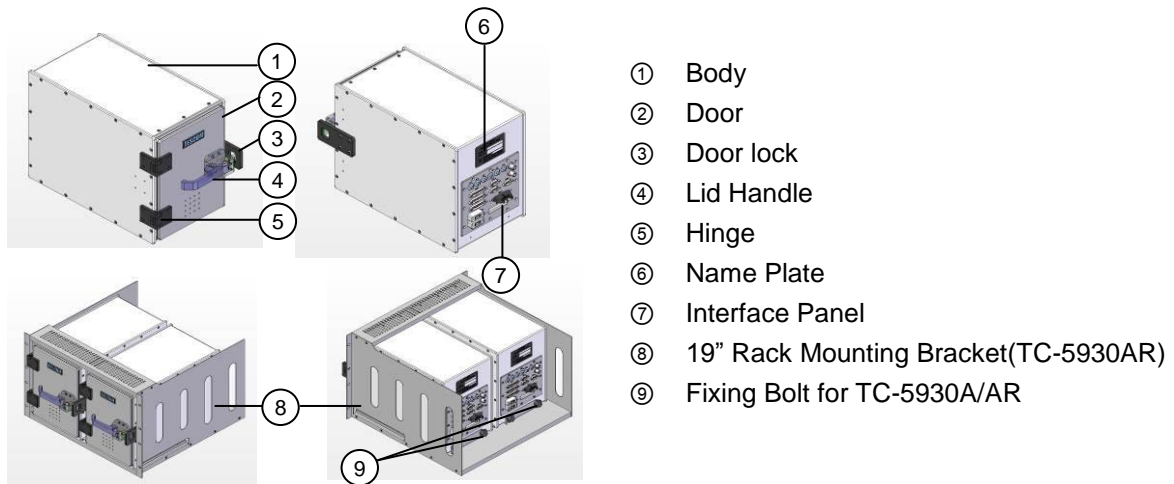

[Figure 6] TC-5930A/AR Component Identification

Changing the opening direction of the door

- 1) Remove screws for door lock and holder on the side of a shield box
- 2) But, do not remove screws for a handle of a door
- 3) Rotate a door upside down.
- 4) Attach a door lock and tighten screws for it on another side of a shield box.
- 5) Attach a door and tighten screws for it on a shield box.

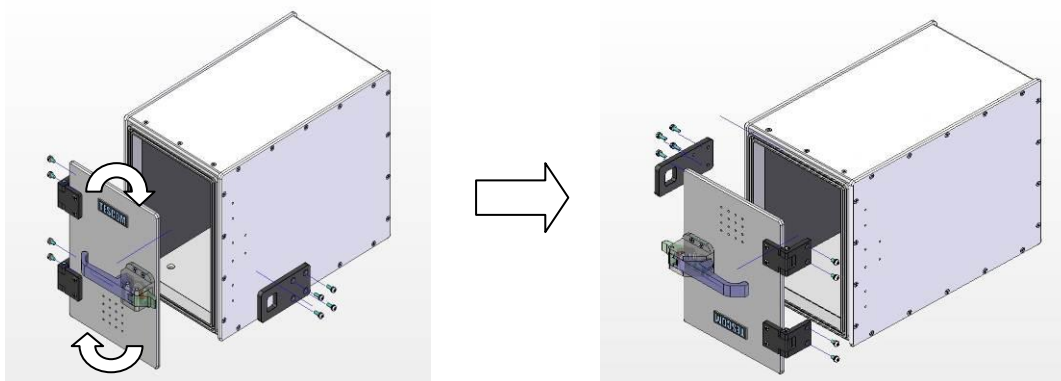

[Figure 7] Changing the opening direction of the door

TC-5972A/C Component Identification

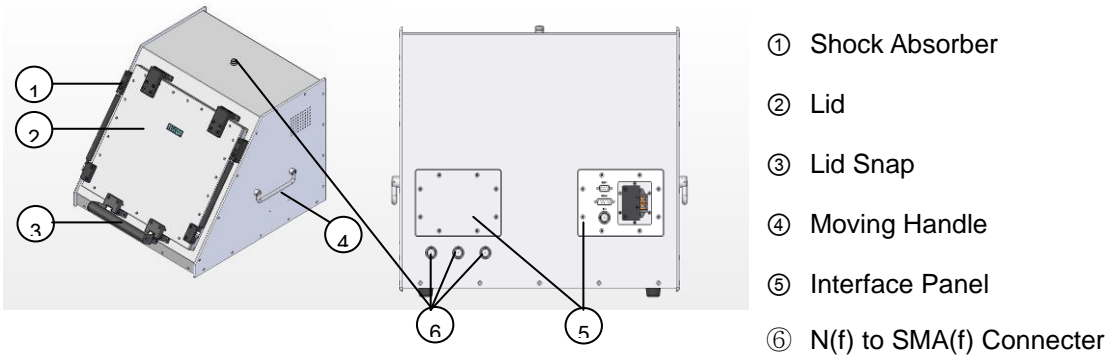

[Figure 8] TC-5972A/C Component Identification

TC-5970B/C Component Identification

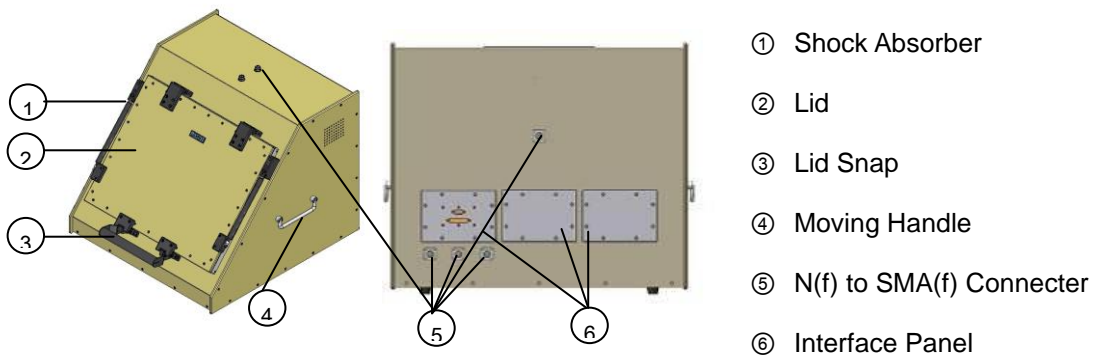

[Figure 9] TC-5970B/C Component Identification

2.2 Maintenance

Shield Box is designed and built for long life and easy maintenance.

Optimal RF shielding is obtained using a shield form gasket between the case and lid. It must be checked periodically for damage or excessive wear that would compromise the seal. Pressure on the gasket by the lid results in a proper RF seal.

Check List for Maintenance

- 1) Check for loose screws and tighten with proper tools, if necessary.
- 2) Check for a loose connection. If a loose connector is found, tighten the connector with proper tools.
- 3) Check for a damaged cable, especially near the connector-cable neck. Replace any damaged cables found.
- 4) Visually inspect the RF seal (gasket) between the bottom shield box case and lid for excessive wear.

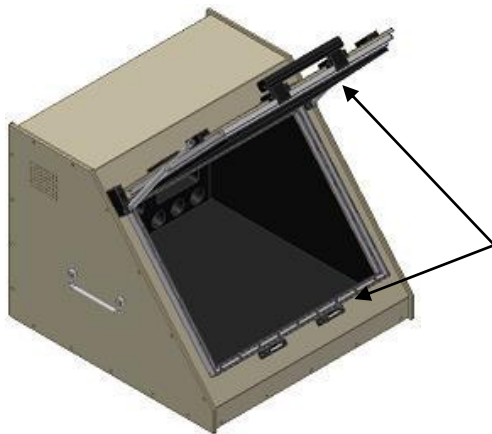

The RF gasket is an important element of optimum shielding. It must be checked periodically for damage or wear out

[Figure 10] Shield Box(ex : TC-5970C)



WARNING

Do not clean this equipment with organic solvents such as benzene, toluene or acetone as they will damage the gasket parts.

2.3 Performance Test

TESCOM Shield Boxes are precision RF devices built very sturdy. Worn out shielding gaskets, as well as metal corrosion or oxidation at the lid contact, can significantly reduce the effectiveness of the Shield Box. This section describes the test procedure for the Shield Boxes shielding effectiveness.



You must performance test and verify shield box specifications every time maintenance is performed on a test cell such as replacing the gasket during routine maintenance. Also performance test the shield box if you suspect mechanical damage

Calibration Period: <6 months

Test Subject: Shielding Effectiveness

Required Equipment

- a. Spectrum Analyzer: 6 GHz
- b. Signal Generator: 6 GHz
- c. Dipole Antenna: TESCOM 900 MHz, 1.8 GHz, 2.4 GHz, 5.8 GHz

Test Connection

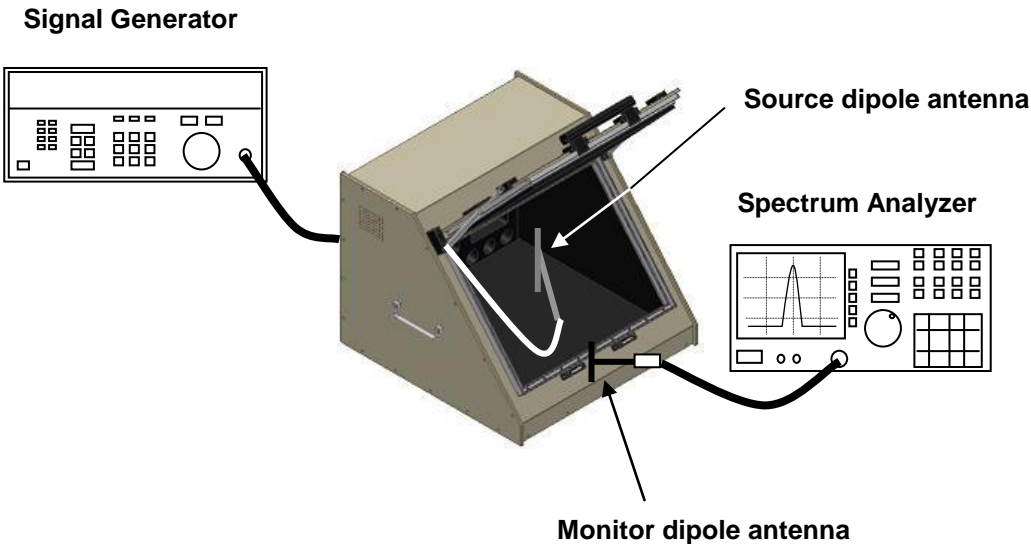

[Figure 11] Shielding Measurement Test Set Up (ex : TC-5970C)



Before making a measurement, visually inspect the shielding gasket around the lid. Replace the gasket if there is any visible damage or excessive wear.

Specification

The Specification for each shield box varies on I/O interface panel. Therefore, please take a look Appendix A and C before order.

TEST Procedure

- 1) Connect the Signal Generator output to the RF connector of the Shield Box.
- 2) Connect the 900 MHz Dipole antenna to the SMA connector inside the Shield Box.
- 3) Set the Signal Generator CW 900 MHz, 10 dBm output.
- 4) Set the HP8562B Spectrum Analyzer as follows:
 - CF: 900 MHz
 - Span: 1 MHz
 - Resolution BW: 10 kHz
 - Scale 10 dB/div
- 5) Connect the 900 MHz Dipole to the Spectrum Analyzer with RF cable.
- 6) Open the lid of the Shield Box and move the antenna around the Shield Box to find the location where the maximum field is found. Fix the location of antenna for maximum field.
- 7) Adjust the spectrum analyzer input range and set the 900 MHz signal to the top display line.
- 8) Close the lid.
- 9) The shield effectiveness, which is measured when the lid opens or closed, should be within the specification in the Appendix A or C.
- 10) Change frequency to 1.8 GHz and repeat the test described above.
- 11) Change frequency to 2.4 GHz and repeat the test described above.
- 12) Change frequency to 5.8 GHz and repeat the test described above.

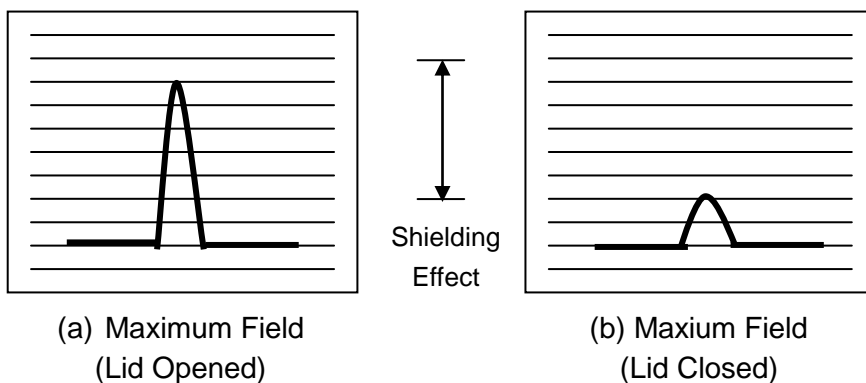

[Figure 12] Spectrum Analyzer Display

APPENDICES

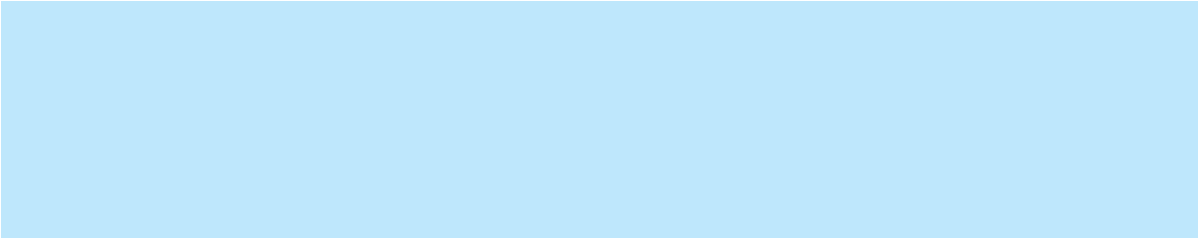

Appendix A

TC-5910D Specification

Mechanical Specification

Dimension	
Inside	130(W) x 235(D) x 138(H) mm
Outside	207(W) x 424(D) x 170(H) mm, lid closed. 435(H) mm, lid open
Weight	approx. 5 kg
*Packing	
Size	365(W) x 450(D) x 280(H) mm
Weight	approx. 6 kg

*The size or weight of a package may vary on how to pack a package.

Typical RF Shielding

The shield effectiveness below is measured when the blank panel is mounted; other I/O interface panel results a different shielding effectiveness of the shield box.

100 to 2000 MHz	> 70 dB
2000 to 3000 MHz	> 70 dB
3000 to 6000 MHz	> 50 dB

TC-5915A Specification

Mechanical Specification

Dimension	
Inside	220(W) x 280(D) x 170(H) mm
Outside	325(W) x 475(D) x 224(H) mm, lid closed. 442(H) mm, lid open
Weight	approx. 9 kg
*Packing	
Size	460(W) x 528(D) x 335(H) mm
Weight	approx. 10 kg

*The size or weight of a package may vary on how to pack a package.

Typical RF Shielding

The shield effectiveness below is measured when the blank panel is mounted; other I/O interface panel results a different shielding effectiveness of the shield box.

100 to 2000 MHz	> 70 dB
2000 to 3000 MHz	> 70 dB
3000 to 6000 MHz	> 50 dB

TC-5916A Specification

Mechanical Specification

RF Connectors without module	2 N (f) outside and SMA (f) inside
Dimension	
Inside	310(W) x 280(D) x 200(H) mm
Outside	400(W) x 475(D) x 240(H) mm, lid closed. 446(H) mm, lid open
Weight	approx. 10 kg
*Packing	
Size	460(W) x 528(D) x 335(H) mm
Weight	approx. 11 kg

*The size or weight of a package may vary on how to pack a package.

Typical RF Shielding

The shield effectiveness below is measured when the blank panel is mounted; other I/O interface panel results a different shielding effectiveness of the shield box.

100 to 2000 MHz	> 60 dB
2000 to 3000 MHz	> 60 dB
3000 to 6000 MHz	> 50 dB

TC-5920A Specification

Mechanical Specification

RF Connectors without module	4 SMA (f) outside and SMA (f) inside
Dimension	
Inside	182(W) x 380(D) x 210(H) mm
Outside	212(W) x 478(D) x 262(H) mm. lid closed. 657(H) mm, lid open.
Weight	approx. 13 kg
*Packing	
Size	370(W) x 595(D) x 382(H) mm
Weight	approx. 14 kg

*The size or weight of a package may vary on how to pack a package.

Typical RF Shielding

The shield effectiveness below is measured when the blank panel is mounted; other I/O interface panel results a different shielding effectiveness of the shield box.

100 to 2000 MHz	> 60 dB
2000 to 3000 MHz	> 60 dB
3000 to 6000 MHz	> 55 dB

TC-5922A Specification

Mechanical Specification

RF Connectors without module	2 N (f) outside and SMA (f) inside
Dimension	
Inside	296(W) x 435(D) x 232(H) mm
Outside	382(W) x 560(D) x 290(H) mm, lid closed. 680(H) mm, lid open.
Weight	approx. 22 kg
*Packing	
Size	620(W) x 800(D) x 530(H) mm
Weight	approx. 25 kg

*The size or weight of a package may vary on how to pack a package.

Typical RF Shielding

The shield effectiveness below is measured when the blank panel is mounted; other I/O interface panel results a different shielding effectiveness of the shield box.

100 to 2000 MHz	> 65 dB
2000 to 3000 MHz	> 65 dB
3000 to 6000 MHz	> 55 dB

TC-5930A/AR Specification

Mechanical Specification

Dimension	
Inside	170(W) x 313(D) x 240(H) mm
Outside	217(W) x 398(D) x 282(H) mm
Door	163(W) x 238(H) mm
Weight	approx. 8.5 kg
*Packing	
Size	360(W) x 515(D) x 397(H) mm
Weight	approx. 11 kg

*The size or weight of a package may vary on how to pack a package.

Typical RF Shielding

The shield effectiveness below is measured when the blank panel is mounted; other I/O interface panel results a different shielding effectiveness of the shield box.

100 to 2000 MHz	> 70 dB
2000 to 3000 MHz	> 60 dB
3000 to 6000 MHz	> 55 dB

TC-5972A/C Specification

Mechanical Specification

RF Connectors without module	4 N (f) outside and SMA (f) inside
Dimension	
Inside	470(W) x 470(D) x 360(H) mm, 230(D)mm top side
Outside	546(W) x 620(D) x 444(H) mm, door closed. 736(H) mm, door open
Door	420(W) x 358(H)
Weight	approx. 27 kg(TC-5972A), approx. 28 kg(TC-5972C)
*Packing	
Size	630(W) x 810(D) x 575(H) mm
Weight	approx. 34 kg(TC-5972A), approx. 38 kg(TC-5972C)

*The size or weight of a package may vary on how to pack a package.

Typical RF Shielding

The shield effectiveness below is measured when the blank panel is mounted; other I/O interface panel results a different shielding effectiveness of the shield box.

100 to 2000 MHz	> 70 dB
2000 to 3000 MHz	> 60 dB
3000 to 6000 MHz	> 55 dB

TC-5970B/C Specification

Mechanical Specification

RF Connectors without module	6 N (f) outside and SMA (f) inside
Dimension	
Inside	530(W) x 540(D) x 420(H) mm, 195(D)mm top side
Outside	620(W) x 680(D) x 531(H) mm, door closed. 890(H) mm, door open
Weight	38 kg(TC-5970B), 50 kg(TC-5970C)
*Packing	
Size	720(W) x 845(D) x 663(H) mm
Weight	approx. 45 kg(TC-5970B), approx. 59 kg(TC-5970C)

*The size or weight of a package may vary on how to pack a package.

Typical RF Shielding

The shield effectiveness below is measured when the blank panel is mounted; other I/O interface panel results a different shielding effectiveness of the shield box.

100 to 2000 MHz	> 70 dB
2000 to 3000 MHz	> 60 dB
3000 to 6000 MHz	> 55 dB

Appendix B

TC-5910D Accessories list

[Table 2] TC-5910D Accessories list

Order Number	Description
TC-5910D	Shield Box (including accessories bellow)
	Operating Manual
	Test Report
	RG400S, N(m) to N(m) cable, 1 m, 1 pc

TC-5915A Accessories list

[Table 3] TC-5915A Accessories list

Order Number	Description
TC-5915A	Shield Box (including accessories bellow)
	Operating Manual
	Test Report
	RG400S, N(m) to N(m) cable, 1 m, 1 pc

TC-5916A Accessories list

[Table 4] TC-5916A Accessories list

Order Number	Description
TC-5916A	Shield Box (including accessories bellow)
	Operating Manual
	Test Report
	RG400S, N(m) to N(m) cable, 1 m, 1 pc

TC-5920A Accessories list

[Table 5] TC-5920A Accessories list

Order Number	Description
TC-5920A	Shield Box (including accessories bellow)
	Operating Manual
	Test Report
	RG400S, N(m) to N(m) cable, 1 m, 1 pc.

TC-5922A Accessories list

[Table 6] TC-5922A Accessories list

Order Number	Description
	Shield Box (including accessories below)
TC-5922A	Operating Manual Test Report RG400S, N(m) to N(m) 1 m, 1 pc

TC-5930A/AR Accessories list

[Table 7] TC-5930A/AR Accessories list

Order Number	Description
	Shield Box (including accessories below)
TC-5930A	Operating Manual Test Report SS-402, N(m) to N(m) cable, 1 m, 1 pc
	Shield Box (TC-5930A 2 EA , 19" Rack Mount Bracket, include accessories below)
TC-5930AR	Operating Manual Test Report SS-402, N(m) to N(m) cable, 1 m, 2 pcs

TC-5972A/C Accessories list

[Table 8] TC-5972A/C Accessories list

Order Number	Description
	Shield Box (including accessories below)
TC-5972A	Operating Manual Test Report RG400S, N(m) to N(m) cable, 1 m, 1 pc
	Shield Box (including accessories below)
TC-5972C	Operating Manual Test Report RG400S, N(m) to N(m) cable, 1 m, 1 pc

TC-5970B/C Accessories list

[Table 9] TC-5970B/C Accessories list

Order Number	Description
TC-5970B	Shield Box (including accessories bellow)
	Operating Manual
	Test Report
	RG400S, N(m) to N(m) cable, 1 m, 1 pc
TC-5970C	Shield Box (including accessories bellow)
	Operating Manual
	Test Report
	RG400S, N(m) to N(m) cable, 1 m, 1 pc

Appendix C

TC-5910D Optional I/O Interface Panel

[Table 10] TC-5910D I/O Interface Panel

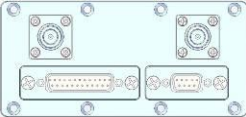
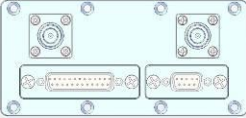
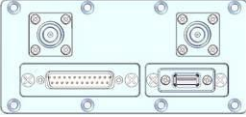
	Order Number	Configuration
 <p>Data Interface Panel</p>	M591011A	<ul style="list-style-type: none"> *Shielding Effectiveness:>70 dB from 0.1 to 2 GHz, >60 dB from 2 to 3 GHz, >55 dB from 3 to 6 GHz DB9(p) outside and DB9(s) inside, 1000 pF Pi filter DB25(p) outside and DB25(s) inside, 1000 pF Pi filter 2 N(f) outside and SMA(f) inside Data line Capacity : 100 VDC, 3 Amps max
 <p>Data Interface Panel</p>	M591011B	<ul style="list-style-type: none"> *Shielding Effectiveness: >70 dB from 0.1 to 2 GHz, >60 dB from 2 to 3 GHz, >55 dB from 3 to 6 GHz DB9(p) outside and DB9(s) inside, 100 pF Pi filter DB25(p) outside and DB25(s) inside, 100 pF Pi filter 2 N(f) outside and SMA(f) inside Data line Capacity : 100 VDC, 3 Amps max
 <p>USB2.0 Interface Panel</p>	M591012A	<ul style="list-style-type: none"> *Shielding Effectiveness: >60 dB from 0.1 to 6 GHz DB25(p) outside and DB25(s) inside, 100 pF Pi filter USB A(p), 10 pF Pi filter Data line Capacity : 100 VDC, 3 Amps max

*Each shielding effectiveness is measured when each I/O interface panel, which is shown above, is mounted.

TC-5915A Optional I/O Interface Panel

[Table 11] TC-5915A I/O Interface Panel

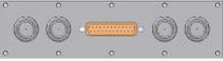
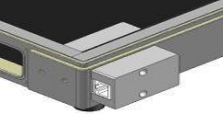
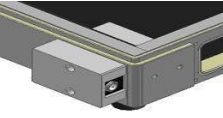
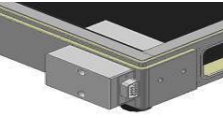
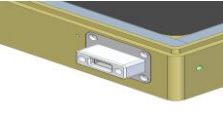
	Order Number	Configuration
 <p>Data Interface Panel</p>	M591502B	<ul style="list-style-type: none"> *Shielding Effectiveness:>70 dB from 0.1 to 2 GHz, >60 dB from 2 to 3 GHz, >55 dB from 3 to 6 GHz DB9(p) outside and DB9(s) inside, 1000 pF Pi filter DB25(p) outside and DB25(s) inside, 1000 pF Pi filter 2 N(f) outside and SMA(f) inside Data line Capacity : 100 VDC, 3 Amps max.
 <p>Data Interface Panel</p>	M591505A	<ul style="list-style-type: none"> *Shielding Effectiveness:>70 dB from 0.1 to 2 GHz, >60 dB from 2 to 3 GHz, >55 dB from 3 to 6 GHz DB25(p) outside and DB25(s) inside, 1000 pF Pi filter 4 N(f) outside and SMA(f) inside Data line Capacity : 100 VDC, 3 Amps max.
 <p>RJ-45 Interface Panel</p>	M591531A	<ul style="list-style-type: none"> *Shielding Effectiveness:>60 dB from 0.1 to 3 GHz RJ-45 outside and inside, 10pF Pi filter, for LAN Data line Capacity : 1.5 Amps max.
 <p>DC Power interface Panel</p>	M591532A	<ul style="list-style-type: none"> *Shielding Effectiveness:>70 dB from 0.1 to 2 GHz, >60 dB from 2 to 3 GHz, >55 dB from 3 to 6 GHz DC Power Jack outside and inside Data line Capacity : 100 VDC, 3 Amps max.
 <p>DB9 Interface Panel</p>	M591533A	<ul style="list-style-type: none"> *Shielding Effectiveness:>70 dB from 0.1 to 2 GHz, >60 dB from 2 to 3 GHz, >55 dB from 3 to 6 GHz DB9(p) outside and DB9(s) inside, 1000 pF Pi filter Data line Capacity : 100 VDC, 3 Amps max.
 <p>USB Interface Panel</p>	M591534B	<ul style="list-style-type: none"> *Shielding Effectiveness:>60 dB from 0.1 to 6 GHz USB A(p) 2.0, 10 pF Pi filter Data line Capacity : 1 Amps max. (Frequency range : 200 MHz ~ 5.8 GHz) ※ Only for USB to USB Connection

*Each shielding effectiveness is measured when each I/O interface panel, which is shown above, is mounted.

TC-5916A Optional I/O Interface Panel



[Table 12] TC-5916A I/O Interface Panel

	Order Number	Configuration
 <p>Data Interface Panel</p>	M591602A	<ul style="list-style-type: none"> *Shielding Effectiveness:>60 dB from 0.1 to 6 GHz DB9(p) outside and DB9(s) inside, 100 pF Pi filter DB25(p) outside and DB25(s) inside, 1000 pF Pi filter USB A (p) 2.0 10 pF Pi filter Data line Capacity: 100 VDC, 3 Amps max.

*Each shielding effectiveness is measured when each I/O interface panel, which is shown above, is mounted.

TC-5920A Optional I/O Interface Panel

[Table 13] TC-5920A I/O Interface Panel

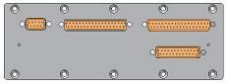
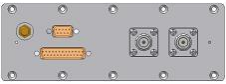
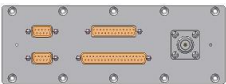
	Order Number	Configuration
 <p>Blank Panel</p>	M592001A	
 <p>Data Interface Panel</p>	M592002A	<ul style="list-style-type: none"> *Shielding Effectiveness:>70 dB from 0.1 to 2 GHz, >60 dB from 2 to 3 GHz, >55 dB from 3 to 6 GHz DB9(p) outside and DB9(s) inside, 1000 pF Pi filter DB25(p) outside and DB25(s) inside, 1000 pF Pi filter 2 N(f) outside and SMA(f) inside
 <p>Data Interface Panel</p>	M592003A	<ul style="list-style-type: none"> *Shielding Effectiveness:>70 dB from 0.1 to 2 GHz, >60 dB from 2 to 3 GHz, >55 dB from 3 to 6 GHz DB9(p) outside and DB9(s) inside, 1000 pF Pi filter DB25(p) outside and DB25(s) inside, 1000 pF Pi filter 2 DB37(p) outside and DB37(s) inside, 1000 pF Pi filter
 <p>Data Interface Panel</p>	M592004A	<ul style="list-style-type: none"> *Shielding Effectiveness:>70 dB from 0.1 to 2 GHz, >60 dB from 2 to 3 GHz, >55 dB from 3 to 6 GHz Air fitting, 6mm OD. DB9(p) outside and DB9(s) inside, 1000 pF Pi filter DB25(p) outside and DB25(s) inside, 1000 pF Pi filter 2 N(f) outside and SMA(f) inside
 <p>Data Interface Panel</p>	M592005A	<ul style="list-style-type: none"> *Shielding Effectiveness:>70 dB from 0.1 to 2 GHz, >60 dB from 2 to 3 GHz, >55 dB from 3 to 6 GHz 2 DB9(p) outside and DB9(s) inside, 1000 pF Pi filter DB25(p) outside and DB25(s) inside, 1000 pF Pi filter DB37(p) outside and DB37(s) inside, 1000 pF Pi filter N(f) outside and SMA(f) inside

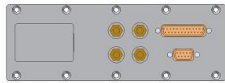

Data Interface Panel

M592007A

- *Shielding Effectiveness: >60 dB from 0.1 to 3 GHz
- DB9(p) outside and DB9(s) inside, 1000 pF Pi filter
- DB25(p) outside and DB25(s) inside, 1000 pF Pi filter
- 4 SMA(f) outside and SMA(f) inside
- RJ-45 outside and inside, 10 pF Pi filter, for LAN

*Each shielding effectiveness is measured when each I/O interface panel, which is shown above, is mounted.

TC-5922A Optional I/O Interface Panel

[Table 14] TC-5922A I/O Interface Panel

	Order Number	Configuration
<p>Blank Panel</p>	M592001A	
<p>Data Interface Panel</p>	M592002A	<ul style="list-style-type: none"> • *Shielding Effectiveness:>70 dB from 0.1 to 2 GHz, >60 dB from 2 to 3 GHz, >55 dB from 3 to 6 GHz • DB9(p) outside and DB9(s) inside, 1000 pF Pi filter • DB25(p) outside and DB25(s) inside, 1000 pF Pi filter • 2 N(f) outside and SMA(f) inside
<p>Data Interface Panel</p>	M592003A	<ul style="list-style-type: none"> • *Shielding Effectiveness:>70 dB from 0.1 to 2 GHz, >60 dB from 2 to 3 GHz, >55 dB from 3 to 6 GHz • DB9(p) outside and DB9(s) inside, 1000 pF Pi filter • DB25(p) outside and DB25(s) inside, 1000 pF Pi filter • 2 DB37(p) outside and DB37(s) inside, 1000 pF Pi filter
<p>Data Interface Panel</p>	M592004A	<ul style="list-style-type: none"> • *Shielding Effectiveness:>70 dB from 0.1 to 2 GHz, >60 dB from 2 to 3 GHz, >55 dB from 3 to 6 GHz • Air fitting, 6mm OD. • DB9(p) outside and DB9(s) inside, 1000 pF Pi filter • DB25(p) outside and DB25(s) inside, 1000 pF Pi filter • 2 N(f) outside and SMA(f) inside
<p>Data Interface Panel</p>	M592005A	<ul style="list-style-type: none"> • *Shielding Effectiveness:>70 dB from 0.1 to 2 GHz, >60 dB from 2 to 3 GHz, >55 dB from 3 to 6 GHz • 2 DB9(p) outside and DB9(s) inside, 1000 pF Pi filter • DB25(p) outside and DB25(s) inside, 1000 pF Pi filter • DB37(p) outside and DB37(s) inside, 1000 pF Pi filter • N(f) outside and SMA(f) inside
<p>Data Interface Panel</p>	M592007A	<ul style="list-style-type: none"> • *Shielding Effectiveness: >60 dB from 0.1 to 3 GHz • DB9(p) outside and DB9(s) inside, 1000 pF Pi filter • DB25(p) outside and DB25(s) inside, 1000 pF Pi filter • 4 SMA(f) outside and SMA(f) inside • RJ-45 outside and inside, 10 pF Pi filter, for LAN

*Each shielding effectiveness is measured when each I/O interface panel, which is shown above, is mounted.

TC-5930A/AR Optional I/O Interface Panel

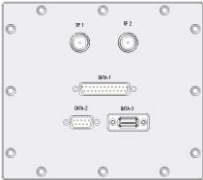
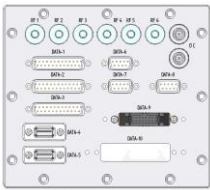

[Table 15] TC-5930A/AR I/O Interface Panel

	Order Number	Configuration
 <p>RF and DATA Panel</p>	M5930A01A	<ul style="list-style-type: none"> *Shielding Effectiveness:>70 dB from 0.1 to 2 GHz, >60 dB from 2 to 3 GHz, >50 dB from 3 to 6 GHz 2 N (f) outside and SMA (f) inside 1 DB25(p) outside, DB25(s) inside, 1000 pF Pi filter 1 DB9(p) outside, DB9(s) inside, 1000 pF Pi filter 1 USB A(p), 10 pF Pi filter
 <p>RF and AC Power Panel</p>	M5930A02A	<ul style="list-style-type: none"> *Shielding Effectiveness:>60 dB from 0.1 to 2 GHz, >55 dB from 2 to 3 GHz, >50 dB from 3 to 6 GHz 6 SMA (f) outside and SMA (f) inside 2 DC, 3A 3 DB25(p) outside, DB25(s) inside, 100 pF Pi filter 3 DB9(p) outside, DB9(s) inside, 100 pF Pi filter 2 USB A(p), 10 pF Pi filter 2 DC Power Jack 1 SDIO 1 HDMI

*Each shielding effectiveness is measured when each I/O interface panel, which is shown above, is mounted.

TC-5972A/C Optional I/O Interface Panel

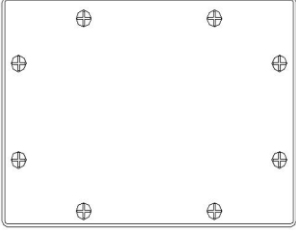
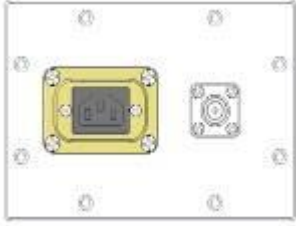

[Table 16] TC-5972A/C I/O Interface Panel

	Order Number	Configuration
 <p>Blank Panel</p>	M5970C01A	<ul style="list-style-type: none"> *Shielding Effectiveness: >70 dB from 0.1 to 2 GHz, >60 dB from 2 to 3 GHz, >55 dB from 3 to 6 GHz
 <p>RF and AC Power Panel</p>	M5970C02A	<ul style="list-style-type: none"> *Shielding Effectiveness:>70 dB from 0.1 to 3 GHz, >60 dB from 3 to 6 GHz 1 N (f) outside and SMA (f) inside AC Inlet, 100 VAC~300 VAC, 10 A
 <p>RF and RJ45, DB25 Data Interface Panel</p>	M5970C03A	<ul style="list-style-type: none"> *Shielding Effectiveness:>60 dB from 0.1 to 3 GHz, >55 dB from 3 to 6 GHz 1 N (f) outside and SMA (f) inside RJ-45 outside and inside, 10 pF Pi filter One DB25(p) outside, DB25(s) inside, 1000 pF Pi filter
 <p>RF and USB, DB25 Data Interface Panel</p>	M5970C04A	<ul style="list-style-type: none"> *Shielding Effectiveness:>60 dB from 0.1 to 3 GHz, >55 dB from 3 to 6 GHz 1 N (f) outside and SMA (f) inside USB outside and inside One DB25(p) outside, DB25(s) inside, 1000 pF Pi filter

*Each shielding effectiveness is measured when each I/O interface panel, which is shown above, is mounted.

TC-5970B/C Optional I/O Interface Panel

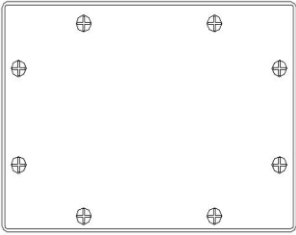
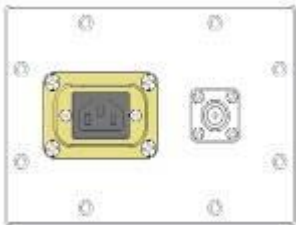
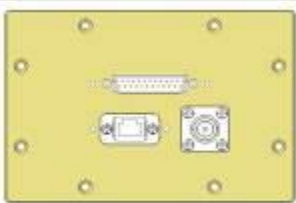
[Table 17] TC-5970B/C I/O Interface Panel

	Order Number	Configuration
 <p>Blank Panel</p>	M5970C01A	<ul style="list-style-type: none"> *Shielding Effectiveness: >70 dB from 0.1 to 2 GHz, >60 dB from 2 to 3 GHz, >55 dB from 3 to 6 GHz
 <p>RF and AC Power Panel</p>	M5970C02A	<ul style="list-style-type: none"> *Shielding Effectiveness:>70 dB from 0.1 to 3 GHz, >60 dB from 3 to 6 GHz 1 N (f) outside and SMA (f) inside AC Inlet, 100 VAC~300 VAC, 10 A
 <p>RF and RJ45, DB25 Data Interface Panel</p>	M5970C03A	<ul style="list-style-type: none"> *Shielding Effectiveness:>60 dB from 0.1 to 3 GHz, >55 dB from 3 to 6 GHz 1 N (f) outside and SMA (f) inside RJ-45 outside and inside, 10 pF Pi filter One DB25(p) outside, DB25(s) inside, 1000 pF Pi filter
 <p>RF and USB, DB25 Data Interface Panel</p>	M5970C04A	<ul style="list-style-type: none"> *Shielding Effectiveness:>60 dB from 0.1 to 3 GHz, >55 dB from 3 to 6 GHz 1 N (f) outside and SMA (f) inside USB outside and inside One DB25(p) outside, DB25(s) inside, 1000 pF Pi filter

*Each shielding effectiveness is measured when each I/O interface panel, which is shown above, is mounted.