

DESCRIPTION

AT series converter / distributor primarily designed for use in the general signal conversion and isolation circuit ; as 4~20mA 、0~10V 、Thermocouple(Type K, J, E, T)、Rtd (Pt100Ω)、Load Cell、Potentiometer and AC Voltage/Current... Complete models ◦

This section slim design of the converter / distributor, in addition to providing two groups of signal output (Isolation) or 24V excitationsuppl the transmitter used, the switching power supply will provide installation convenience. The top and designed power supply, input and output indicators and removable terminal blocks to facilitate on-site construction and working status view.



Model	Measurement / Input	Analogue Output	Excitation Output
AT-VA	AC/DC Voltage 0~150V, 0~300V, 0~500V(specify) AC/DC Current 0 ~ 5A, 0~1A(specify), DC 0~50mV, 0~60mV, 0~75mV, 0~100mV	1 OR 2	NA
AT-PR	DC Current 0/4~20mA, Voltage 0/1~5/10V (Choose DP-type , switchable)	1 OR 2	Option 24V/30mA
AT-TR	Rtd temperature Pt100Ω	1 OR 2	NA
AT-TC	Thermo-couple temperature Type K, J, E, T	1 OR 2	NA
AT-SG	Strain Gauge 0~1.0mV/~2.0mV/~3.0mV/~4.0mV per 1 voltage supply	1	10V/30mA
AT-PM	Potential-meter 0~2.0kΩ(3 wire), 2.0kΩ~100.0kΩ(3 wire)	1 OR 2	NA
AT-RS	Resistance 0~200Ω/~200KΩ(2 wire)	1 OR 2	NA

FEATURE

- Output for 0~5V / 0~10V / 1~5V / 2~10V / 4~20mA / 0~20mA changeable by dip switches and terminals
- Dual different signals output available
- LED indications for power, input and output status
- 0.1% accuracy available in option
- 17.5 mm thin profile and 35mm DIN rail mounting
- CE Approved & RoHS

ORDERING INFORMATION

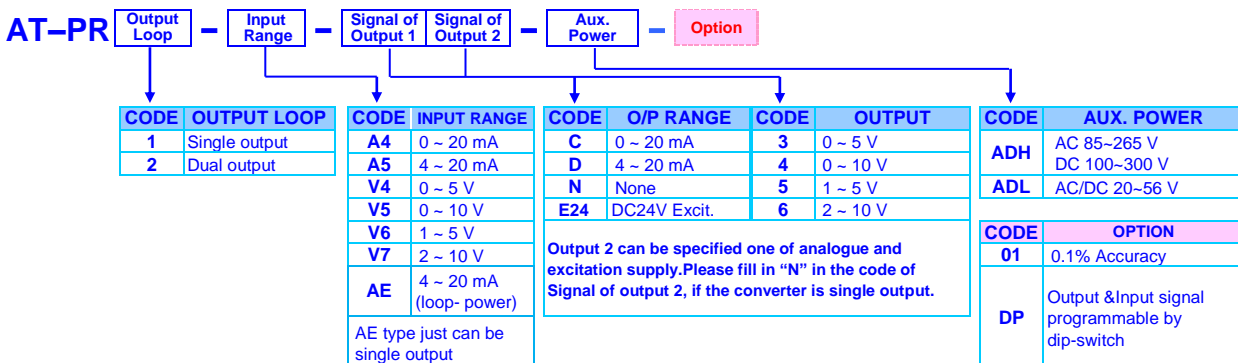
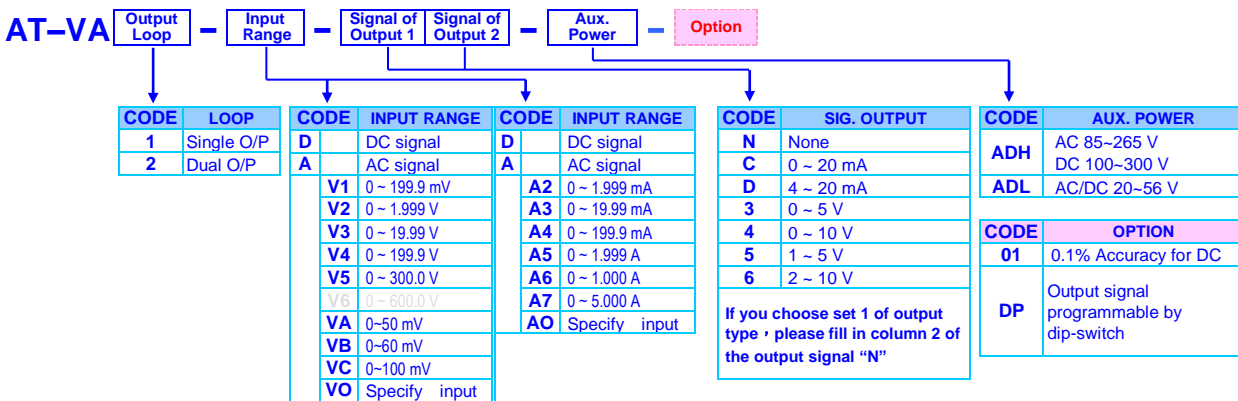

AT-TR

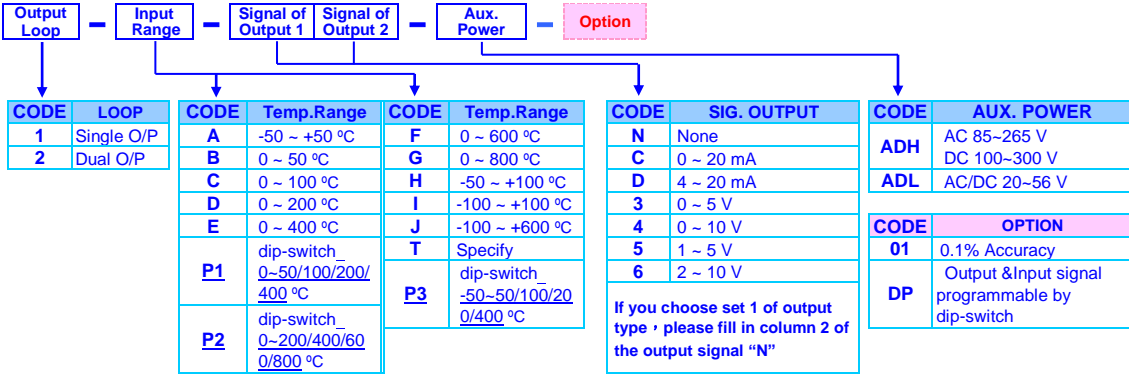

AT-TC

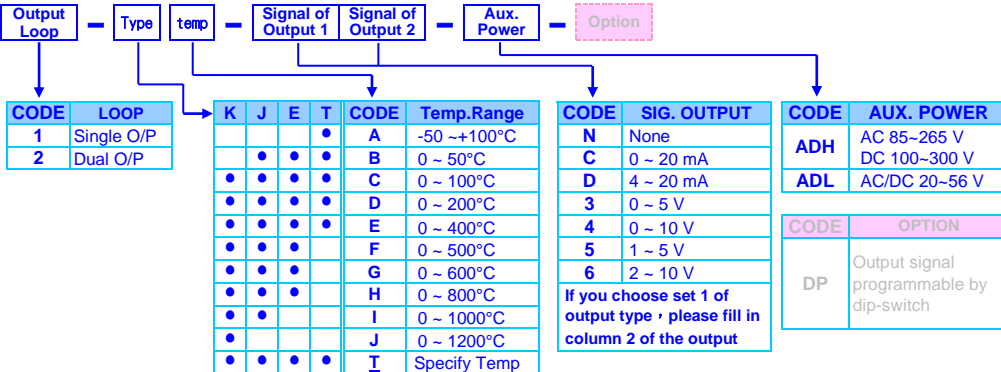

AT-PM

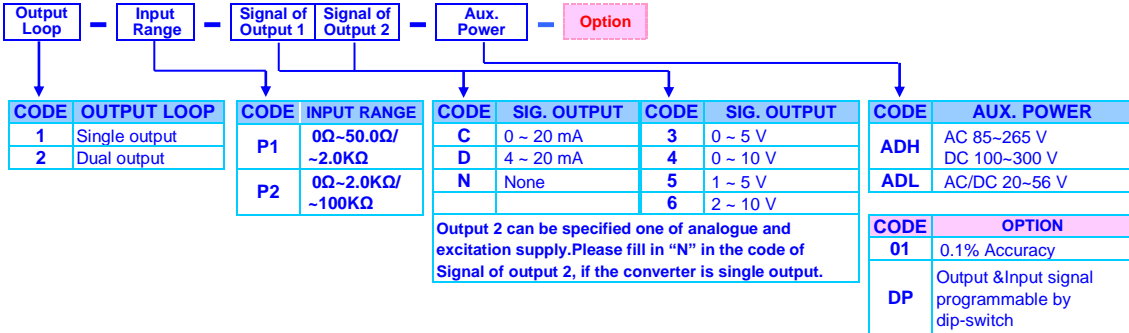

AT-RS

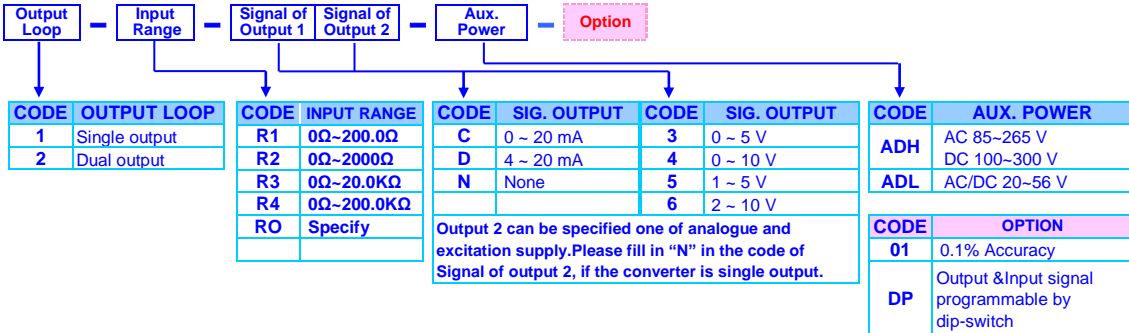

AT-SG

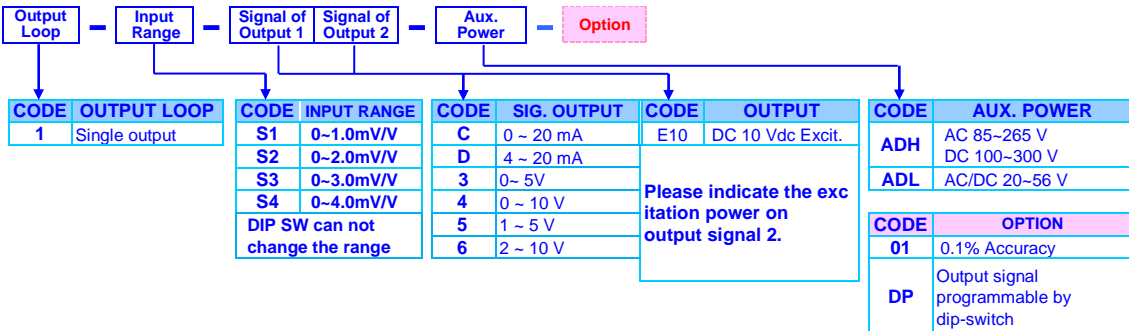

■ TECHNICAL SPECIFICATION

input Signal (Can be specified dip-switch programmable – option “DP”)

Accuracy: $\leq \pm 0.2\%$ of F.S.(delivered in customer's specify)
 $\leq \pm 0.1\%$ of F.S.(Option)
 Excitation power: 10V/30mA

AT-VA(Voltage or Current)

Input range DC / AC	Input Impedance	Input range DC / AC	Input Impedance
Votlag	0~50/~100 mV	Curre	0~1.999 mA
	0~199.9 mV		100 ohm
	0~1.999 V		10 ohm
	0~19.99 V		1 ohm
	0~199.9 V		0.05 ohm
	0~300.0 V		0.02 ohm
0~500.0 V	$\geq 2M$ ohm		

Accuracy: AC: $\leq \pm 0.5\%$ of F.S.(delivered in customer's specify)
 DC: $\leq \pm 0.2\%$ of F.S.(delivered in customer's specify)
 DC: $\leq \pm 0.1\%$ of F.S.(delivered in customer's specify)
 $\leq \pm 2\%$ of F.S.(By Dip-switch)
 Input burden: AC Current: $\leq 0.1VA$; AC Voltage: $\leq 0.15VA$

output Signal (Can be specified dip-switch programmable – option “DP”)

output range	output Impedance	output Signal (Changeable by dip-switch)
0 ~ 20mAdc	$\leq 520\Omega$	Output 1: Io(mA output - terminal 9+ & 8-) Output 1: Vo(V output - terminal 7+ & 8-)
4 ~ 20mAdc	$\leq 520\Omega$	
0 ~ 10Vdc	$\geq 1000\Omega$	
2 ~ 10Vdc	$\geq 1000\Omega$	Output 2: Io(mA output - terminal 12+ & 11-) Output 2: Vo(V output - terminal 10+ & 11-)
0 ~ 5Vdc	$\geq 500\Omega$	
1 ~ 5Vdc	$\geq 500\Omega$	

Standard: please specify in order

Response Time: PR \ TR: ≤ 250 msec (Input10%~Output90% of FS)
 SG \ VA(DC): ≤ 300 msec(Input10%~Output90% of FS)
 TC \ VA(AC): ≤ 500 msec(Input10%~Output90% of FS)

Output ripple: $\leq \pm 0.1\%$ of F.S.
 Span Calibration range: $\leq \pm 10\%$ of F.S. · 2 group individually adjusted
 Zero Calibration range: $\leq \pm 10\%$ of F.S. · 2 group individually adjusted

Isolation: AC 2.0 KV ; Between output 1 & output 2
 Excit. Power: DC 24V, 30mA
 DC 10V, 30mA

Power

Power supply AC 85~265V/DC 100~300V, 50/60Hz
 Power consumption: DC 4W, AC 6.0VA

Environmental

Operating temp.: 0~60 °C
 Operating humi.: 20~95% RH, Non-condensing
 Temp. Coefficient: ≤ 100 PPM/ °C (0~50 °C)
 Storage temp.: -10~70 °C
 Protection: IP 42
 Vibration: 1~800 Hz, 3.175 g²/Hz

Mechanical

Dimensions: 94.0mm x 94.0mm x 17.5mm
 Housing: ABS -Fireproof materials · UL94V0
 Terminals: Pluggable terminal block,
 M2.5 Screw · connect 2 x 2.5mm² wire
 Mounting: 35mm DIN rail (EN50022)
 Weight: 250g

Specification

Electrical Safety(LVD): IEC 61010 (Installation category 3)

EMC: EN 55011:2002; EN 61326:2003

Electric Isolation: AC 2.0KV · for 1min,
 Between Power / Input / Output1 / Output2 / Case

Insulation resistance: $\geq 100M\Omega$ at 500Vdc, Between Power / Input / Output
 EMI: EN 55011:2002; EN 61326:2003

Status Indication

I/O Status Indication: 3 or 4 round LED indication
 Power on, LED bright
 Input signal $\geq 4\sim 6\%$, LED bright
 output 1 and output 2 signal $\geq 4\sim 6\%$, LED bright

AT-PR(0~10V/4~20mA)

Input Range (Selected by terminals)	Input Signal (Changeable by dip-switch)	Input Impedance
0/4 ~ 20 mA (terminal 3+ & 2-)	0~20mA, 4~20mA	250 Ω
0 ~ 10 V (terminal 1+ & 2-)	0~5V, 0~10V, 1~5V, 2~10V	1M Ω

Standard: Can not change the input / output signal, please specify in order

Accuracy: $\leq \pm 0.2\%$ of F.S.(delivered in customer's specify)
 $\leq \pm 0.1\%$ of F.S.(Option)
 $\leq \pm 2\%$ of F.S.(By Dip-switch)

AT-TR (Pt100 Ω)

Input Range	Input Signal (Changeable by dip-switch)	Input Impedance
Pt100 Ω (DIN)	P1 0~50 / 100 / 200 / 400 °C	Selected by Dip-Switch 1M Ω
	P2 0~200 / 400 / 600 / 800 °C	
	P3 -50~50 / 100 / 200 / 400 °C	

Standard: please specify in order

Accuracy: $\leq \pm 0.2\%$ of F.S.(delivered in customer's specify)
 $\leq \pm 0.1\%$ of F.S.(Option)
 $\leq \pm 2\%$ of F.S.(By Dip-switch)

AT-TC (Pt100 Ω)

Type	Measuring Range	Input Impedanc	Type	Measuring Range	Input Impedanc
K	0~1200°C	1M Ω	E	0~800°C	1M Ω
J	0~1000°C	1M Ω	T	-100~400°C	1M Ω

Accuracy: $\leq \pm 0.5\%$ of F.S.(delivered in customer's specify)
 Cold Junction: 25 ± 10 °C, error ≤ 0.5 °C

AT-PM (Potentio-Meter)

Input Signal	Input Impedanc
P1 0 Ω ~50.0 Ω /~2.0K Ω	1M Ω
P2 0 Ω ~2.0K Ω /~100.0K Ω	1M Ω

Accuracy: $\leq \pm 0.2\%$ of F.S.(delivered in customer's specify)
 $\leq \pm 0.1\%$ of F.S.(Option)

Detect Voltage: ≤ 2.0 K Ω ,0.2 V ; ≥ 2.0 K Ω ,1.0 V

AT-RS (Resistance)

Input Range	Input Impedanc	Input Range	Input Impedanc
R1 0.0 Ω ~200.0 Ω	1M Ω	R3 0.0 Ω ~20.0 K Ω	1M Ω
R2 0.0 Ω ~2000.0 Ω	1M Ω	R4 0.0 Ω ~200.0 K Ω	1M Ω

Accuracy: $\leq \pm 0.2\%$ of F.S.(delivered in customer's specify)
 $\leq \pm 0.1\%$ of F.S.(Option)

Detect Current: 1.6mA

AT-SG (Strain Gauge)

Input Range	Input Impedanc	Input Range	Input Impedanc
S1 0.0~1.0mV/V	1M Ω	S3 0.0~3.0 mV/V	1M Ω
S2 0.0~2.0mV/V	1M Ω	S4 0.0~4.0 mV/V	1M Ω

DIMENSIONS

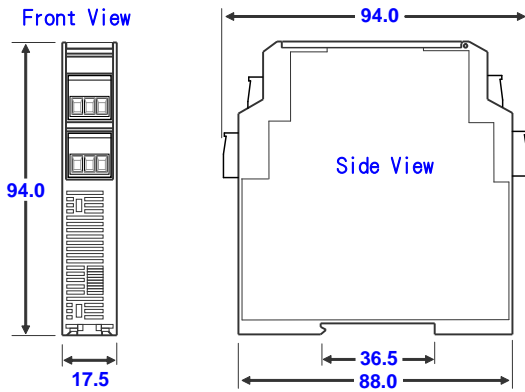

TOP PANEL

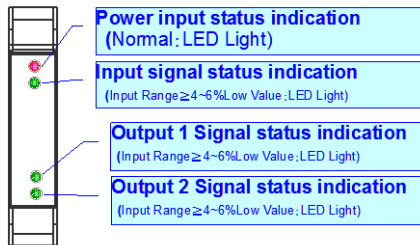

INSTALLATION

The converter should be installed in a location that does not exceed the maximum operating temperature and provides good air circulation

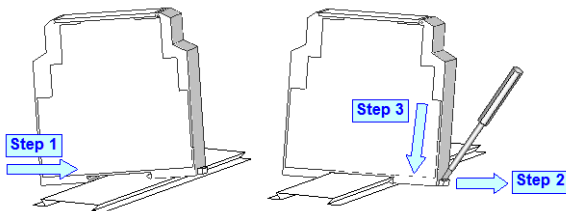

ADJUSTMENT

Customer can specify AT series with dip switch in optional code (-DP) for change of input and output range to save stock.

⚠ Recalibration is recommended after change range.

Signal input change table (by dip switches - option)

The input of AT-VA(AC/DC voltage and Current) can not be changed

AT-PR(0~10V/4~20mA)

Input signal:	Dip-Switch (ZC)			
	SW1	SW2	SW3	SW4
0 ~ 5 V				
0 ~ 10 V		on		
1 ~ 5 V			on	on
2 ~ 10 V		on	on	on
0 ~ 20 mA	on			
4 ~ 20 mA	on		on	on

AT-TR(Pt100Ω)

Signal Range	Dip-Switches - ZB1						Dip-Switches - ZC1			
	SW1	SW2	SW3	SW4	SW5	SW6	SW1	SW2	SW3	SW4
0 ~ 50°C				on			on			
0 ~ 100°C	on				on			on		
0 ~ 200°C		on				on			on	
0 ~ 400°C			on							on

Input Signal: Pt100Ω(Code:P2)

Signal Range	Dip-Switches - ZB1						Dip-Switches - ZC1			
	SW1	SW2	SW3	SW4	SW5	SW6	SW1	SW2	SW3	SW4
0 ~ 200°C				on			on			
0 ~ 400°C	on				on			on		
0 ~ 600°C		on				on			on	
0 ~ 800°C			on							on

Input Signal : Pt100Ω(Code:P3)

Signal Range	Dip-Switches - ZB1						Dip-Switches - ZC1			
	SW1	SW2	SW3	SW4	SW5	SW6	SW1	SW2	SW3	SW4
-50 ~ 50°C				on			on			
-50 ~ 100°C	on				on			on		
-50 ~ 200°C		on				on			on	
-50 ~ 400°C			on							on

AT-PM(Potential-meter (3 wire))

Signal Range	Dip-Switches - ZC1			
	SW1	SW2	SW3	SW4
0~50Ω/-2.0KΩ	on	on	on	on
0~2.0KΩ/-100KΩ	on	on		

AT-RS(Resistance (2 wire))

Signal Range	Dip-Switches - ZB1					
	SW1	SW2	SW3	SW4	SW5	SW6
0 ~ 200Ω	on	on				on
0 ~ 2000Ω	on	on			on	
0 ~ 20.0KΩ	on	on		on		
0 ~ 200.0KΩ	on	on	on			

Output signal switching sheet (dip-switch- option)

Output range	Dip-Switches - ZB/ZA					
	Output 1(ZB) / Output 2(ZA)					
	SW1	SW2	SW3	SW4	SW5	SW6
0 ~ 5 V		on	on	on		on
0 ~ 10 V		on		on		on
1 ~ 5 V	on		on	on		on
2 ~ 10 V	on			on		on
0 ~ 20 mA		on			on	
4 ~ 20 mA	on				on	

Output signal switching sheet (dip-switch- option)Adjustment

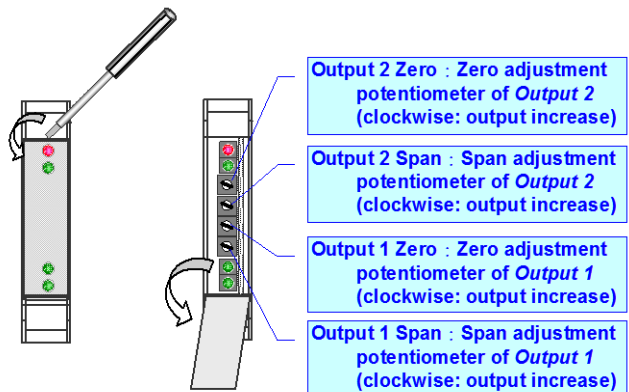

CONNECTION DIAGRAM

The converter has been designed pluggable terminal blocks
 Rated voltage: 300V Rated current: 12A
 Solid wire (AWG): 28~12 Wire strip length: 7~8mm
 Screw: M2.5 Torque: 5.0 Kg-cm

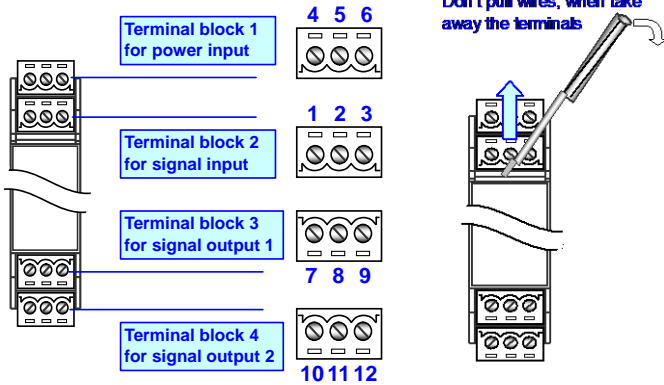

Auxiliary power connection – Terminal block 1

Please check the voltage of power supplied first, and then connect to the specified terminals the meter be protected by a fuse or circuit breaker.

⚠ The connection is maybe change. Please refer to the connection on the label of products

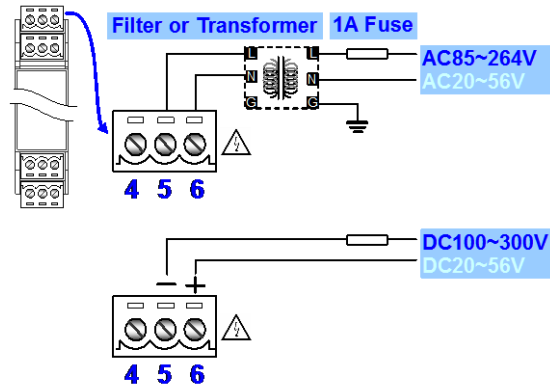

Input signal – Terminal block 2

The converter can be input and output mA and V that depends on the difference terminals wiring.

AT-VA(AC \ DC Voltage/Current) AT-PR(0~10V/4~20mA)

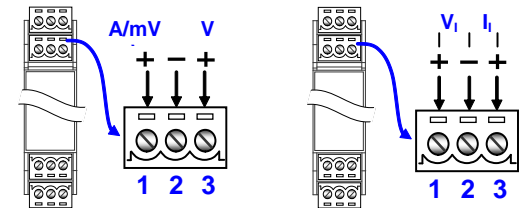

AT-TR(Pt100 Ω) AT-TC(Thermocouple)

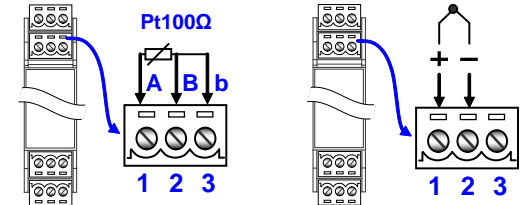

AT-PM(Potential-meter-3 wire) AT-RS(Resistance-2 wire)

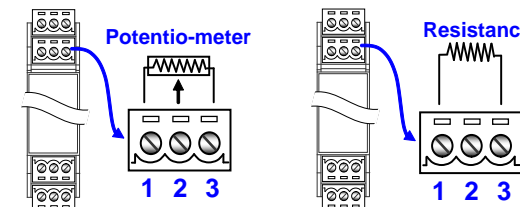

Output signal 1 & 2 – Terminal block 3 & 4

OPTION "DP" Function The converter can be output mA and V that depends on the terminals wiring. (by Dip-switch)

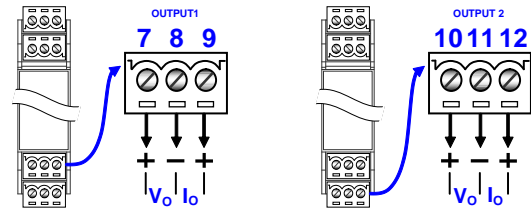

Excitation supply DC24V – Terminal block 4

Output 2 can be specified one of analogue and excitation supply

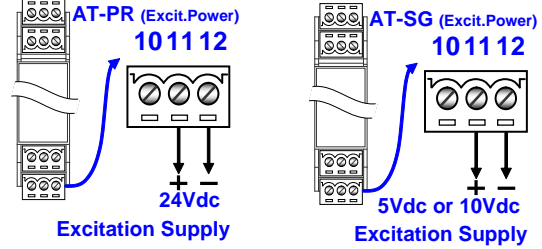

AT-SG WIRING

