

Furniture

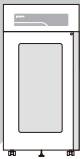

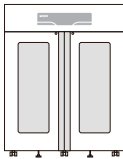

- › Filtering Storage Cabinets
- › Acid/Corrosive Cabinets
- › General Storage Cabinets
- › Gas Cylinder Cabinets





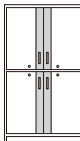



Filtering Storage Cabinets







	FSC-140	FSC-280
		
Internal volume(L)	604	1317
Width(mm)	930	1868
Height(mm)	1890	1890
Depth(mm)	636	636
Airflow rate (m ³ /min, CMM)	0.67	1.34









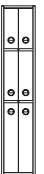
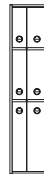
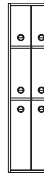

Acid/Corrosive Cabinets

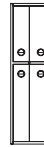

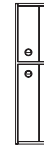

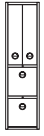

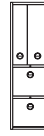

	SC-C1912D4	SC-C1912D2	SC-C1906D2	SC-C1906D1	SC-C0706D1
					
Internal volume(L)	852 (213 x 4 ea)	894 (447 x 2 ea)	426 (213 x 2 ea)	445	115
Width(mm)	1255		655		600
Height(mm)	1900				650
Depth(mm)	555				510

General Storage Cabinets



Base Cabinets	Tabletop type (DS-TT)			Tabletop type (DS-TW)			
							
Width(mm)	476	560	644	472	556	915	1083
Height(mm)	900			900			
Depth(mm)	700			-			
Model	09047-D2	09056-D2	09064-D2	-			
Depth(mm)	550			550			
Model	09047-N2	09056-N2	09064-N2	09047-N1	09055-N1	09091-N2	09108-N2

Base Cabinets	Under table type (DS-UT)			Under table type (DS-UD)			
							
Width(mm)	476	560	644	476	560		
Height(mm)	650			650			
Depth(mm)	700			700			
Model	06047-D2	06056-D2	06064-D2	06047-D2	06047-D3	06056-D2	06056-D3
Depth(mm)	550			550			
Model	06047-N2	06056-N2	06064-N2	06047-N2	06047-N3	06056-N2	06056-N3

Tall Cabinets	Stand type (DS-SL)			Stand type (DS-S)					Combi type (DS-C)				
													
Width(mm)	476	560	644	476	560	644	686	938	476	560			
Height(mm)	2400			1800					1800				
Depth(mm)	700			700					700				
Model	24047-D6	24056-D6	24064-D6	18047-D4	18056-D4	18064-D4	18068-D6	18093-D6	18047-D4	18047-D5	18056-D4	18056-D5	
Depth(mm)	-			550					550				
Model	-			18047-N4	18056-N4	18064-N4	18068-N6	18093-N6	18047-N4	18047-N5	18056-N4	18056-N5	

Tall Cabinets	Window type (DS-OW)				Open rack type (DS-OR)			
								
Width(mm)	472	556	915	1083	472	556	915	1083
Height(mm)	1800				1800			
Depth(mm)	-				550			
Model	-				18047-N1	18055-N1	18091-N2	18108-N2
Depth(mm)	550				550			
Model	18047-N1	18055-N1	18091-N2	18108-N2	18047-N1	18055-N1	18091-N2	18108-N2

Gas Cylinder Cabinets

DS-GC	
	
	
Width(mm)	740
Height(mm)	1800
Depth(mm)	550
Model	18074-N2
	18107-N2

Filtering Storage Cabinets



Storing reagents in this filtering storage cabinet ensures clean lab environment for users.

Feel free to install the cabinet anywhere without any concern of your existing exhaust system. Conveniently place and remove the reagents with the full-extension sliding drawers. Air purification inside the cabinet prevents heating and cooling loss caused by ducted air exhaust systems.



REMOTE CONTROL
with your **MOBILE DEVICE**
see page 8-9



FSC-280 / FSC-140

Standard accessories
see page 44

- Pre filter, LED lamp
- Slide drawers (5ea for FSC-140, 10ea for FSC-280)
- Spill tray (1ea for FSC-140, 2ea for FSC-280)
- Door key

Reliable filter efficiency

- Filtering efficiency of complex carbon filter is proved by 3rd independent institute which describes specification for the gas removal and deodorization efficiency. ; Tested by NH₃, CH₃CHO, CH₃COOH, HCl, NO₂.

Cost-effective filtering system

Energy efficient and space saving filtering system.

- Flexible installation of the cabinet is possible and cost-intensive exhaust air ducts are no longer necessary.
- Air circulation inside the cabinet prevents heating and cooling loss due to the exhaust air, which causes high energy consumption.

Customized filter configuration.

- ISO class 4 (US class 10) HEPA filter for optimal protection against cross-contamination. (optional)
- 0.3 μm and larger particulates are removed with 99.99% efficiency, leak-tight HEPA filter which satisfying class 10. (US Federal Standard 209E) (average life span of HEPA filter: 3 years– it depends on the test room conditions) (optional)
- High-quality polyester fiber pre-filter (with minimal pressure loss and 85% arrestant on the A.F.I. test) for trapping larger particles and increasing the life of the main HEPA filter.
- Convenient filter saturation check and easy filter replacement by an intelligent front cover design.
- Various filters installable at once. Pre filter is built in as standard offer. Maximum two other optional filters are installable.

Multi-functional operation

- User-friendly functions.
 - Auto run on/off; In case of power failure, the unit starts automatically when the unit gets the power back.
 - Set each function's value to best suit the users.
- Safety warning alarms with LED indicators.
 - High temp. alarm with automatic fan stop.
 - Fan fail alarm for abnormal fan stop.
 - Door open alarm to protect users and clean environment.
- Economical and ecofriendly sleep mode.
 - You can set the operating time from 8am to 6pm if your official working hour is from 9am to 6pm. It saves 60% of energy consumption and extends the life span of the fan and filter.
- VOC level indication.
 - Clear and symbolic VOC level bar indicates VOC measurement of the inner cabinet.
 - Real time detecting and displaying are available with VOC sensor inside the cabinet.
- RS-232 interface for external control and data collection.

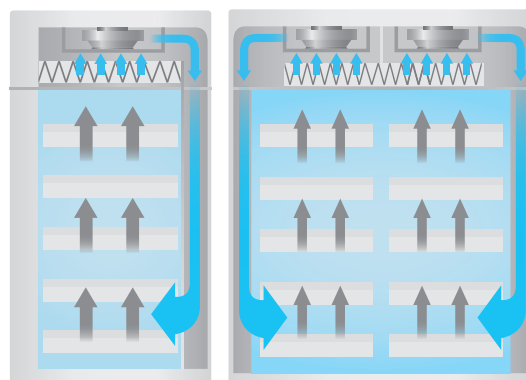

Smooth full-extension sliding drawer



Light-adjustable LED lamp



Spill tray for easy maintenance



Lockable casters for safe installation and easy transport



Built-in door lock for safe sample storage

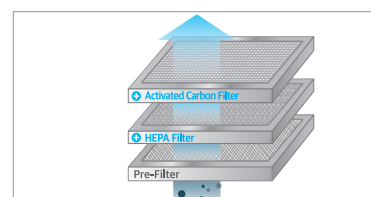

Various filters installable at once
(Pre filter is built in as standard offer. Maximum two other optional filters are installable)

Filtering Storage Cabinets

Convenient and safe storage

- Door and drawer tested in accordance with SEFA.
- It is designed and tested in accordance with SEFA for door hinge test and drawer static load test. The international standard guarantees users the quality and longer use of every unit. In addition, we autonomously conducted the overturning test for more safety.
- Max. 40kg heavy load sustainable inner chamber and drawers. Imagine that just one drawer can dramatically sustain a ten-year-old boy.
- Chemical resistant epoxy coated steel and transparent tempered glass door.
- Corrosion resistant epoxy coated steel for storage of toxic chemical samples.
- All parts of the unit are durably constructed of epoxy coated steel for prevention of corrosion.
- Tempered glass door with LED lamps provides clear observation of stored samples.
- Well designed full length handle let you feel totally relaxed by opening the door at any height.
- Wide inner space use.
- Wide inner space use with the provided extremely smooth full-extension sliding drawers.
- Spill tray and door lock key for clean and safe sample storage.

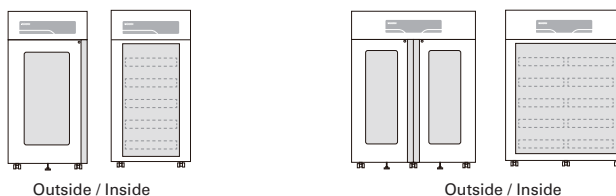

Model		FSC-140	FSC-280
Internal volume (L / cu ft)		604 / 21.3	1317 / 46.5
Capacity ¹⁾ (L / gal , 1L Bottle *ea)		140	280
Airflow rate (m ³ /min, CMM)		0.67	1.34
Pre-filter		Polyester fibers with filter efficiency of 85% (A-F-TEST)	
No. of drawer shelf, Slide (included / max.)		5 / 10	10 / 20
Max. load per shelf (kg / lbs)		40 / 88.2	
Materials	Main body	Epoxy powder coated steel, Glass	
	Display	VFD (vacuum fluorescent display)	
	Lamp	LED	
Noise level (dB)		< 50	< 55
Dimension (WxDxH)	Internal (mm / inch)	795x578x1315 / 31.3x22.8x51.8	1733x578x1315 / 68.2x22.8x51.8
	External (mm / inch)	930x636x1890 / 36.6x25.0x74.4	1868x636x1890 / 73.5x25.0x74.4
	Drawer (mm / inch)	613x478x109 / 24.1x18.8x4.3	613x478x109 / 24.1x18.8x4.3
	Spill tray (mm / inch)	670x526x34 / 26.4x20.7x1.3	670x526x34 / 26.4x20.7x1.3
	Net weight (kg / lbs)	300 / 661.4	495 / 1091.3
Electrical requirements (230V)		60Hz, 0.5A	50Hz, 0.5A
Cat. No.		AAHF1121K	AAHF1122K
Electrical requirements (120V)		60Hz, 1.0A	
Cat. No.		AAHF1123U	
		60Hz, 2.0A	
Cat. No.		AAHF1133U	

1) Basic condition for above capacity is when five drawers are built in.

* Permissible environmental conditions: temperature (5-40°C) and relative humidity (up to 80%). * FDA establishment registered company. FDA listed products.

Accessories & Options

Cat. No.	Description	Application
FSC0079	Pre filter	Larger particles and increasing the life of main filter
FSC0001	HEPA filter	Biohazardous aerosols and other visible and non-visible particles (filtration efficiency: 99.99% at 0.3 microns)
AAAF1537	Complex carbon filter (VOC + NH ₃ + Acid)	Volatile organic compounds (VOC), Ammonia, Acidic solvents ¹⁾ (MA), Alkaline solvents (MB)
AAAF1539	Acid carbon filter ¹⁾	An acidic solvent ; Acetic acid, etc
AAAF1541	Formaldehyde carbon filter	Formadehyde applications
AAAF1542	Ammonia / Amines carbon filter	Ammonia/Amines by chemisorptions

1) Please do not use high percentage of reactive acid such as perchloric acid.

* Each filter should be ordered two for FSC-280.

* Maximum installable filter quantity: 2 ea for FSC-140, 4 ea for FSC-280.



Gateway

Establish Jeio Tech Network by Gateway.

No computer use is required at all.

Cat. No.	Description
AAAQ1011	Gateway (2.4GHz, 100-240V, 50/60Hz)

Cat. No.	Description
AAAB2531	Gas detector (KITAGAWA AP-20)
AAAB1550	Gas detecting tube (Benzene, GASTEC-121SP (0.5-10ppm))
AAAB1551	Gas detecting tube (Toluene, GASTEC-122L (1-100ppm))
AAAB1552	Gas detecting tube (Acetic acid, GASTEC-81L (0.125-25ppm))
AAAB1553	Gas detecting tube (Chloroform, GASTEC-137 (4-400ppm))
AAAB1554	Gas detecting tube (Formaldehyde, GASTEC-91LL (0.05-1ppm))
AAAB1555	Gas detecting tube (Ammonia, GASTEC-3L (0.5-60ppm))



Safety cabinets for long-term storage of corrosive substances.

Durable structure with corrosion-resistant interior non-steel materials.

Efficient ventilation system prevents noxious gas or chemical gas accumulation.



SC-C1912D4, SC-C1906D2

with optional extraction module

Standard accessories • Shelves, Trays, Door key
see page 47

Acid/Corrosive Cabinets

Reliable international standards.

- Designed and tested in accordance with DIN EN 14727.
 - Performance and durability of our cabinet (SC-C1906D2 only) is tested by DIN EN 14727 ensuring safe and reliable use of the acid/corrosive cabinet.
- Reliable chemical test in accordance with SEFA.
 - Chemical test regarding polyphenol resin coated interior, ventilation and exhaust holes are conducted, insuring safe storage of acid/corrosive samples.

Safe storage of corrosive substances.

- Corrosion-resistant interior material.
 - Melamine faced board is suitable for long-term storage of acid / base substance. Non-steel materials for shelves and racks, trays, bolts, ventilation and exhaust holes.
- Robust metal structure.
 - Sturdy steel frame prevents deformation.
 - Epoxy coated surface provides excellent chemical resistance.
- Space-efficient interior design.
 - Internal compartment structure is beneficial for practical and safe space use by organizing the inner space efficiently according to the characteristics of the stored samples. (except for SC-C0706D1)

Sturdy and secure shelf structure.

- Sturdy shelf structure.
 - Max. 80kg heavy load sustainable shelf.
 - Designed to perfectly fastened to both walls.
- Safe shelf design.
 - Shelf with the height of 30mm blocks spreading leakage from accidental sample spillage.
- Chemical-resistant shelves and trays are provided as standard offer.
 - The unit comes together with shelves (except for SC-C0706D1) and polypropylene tray for high chemical resistance.

Safe sample storage by independent gas-ventilation flow

Air-ventilation hole is independently built in each compartment to prevent gas mixture inside of cabinet. This structural benefit enables safe storage of your samples according to the characteristics of the stored samples.

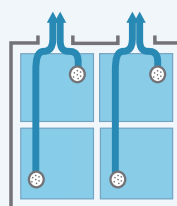

Patent :
10-2015-0141043

Convenient and safe ventilation system.

- Built-in ventilation hole.
 - Ventilation hole on the top and exhaust holes at the back prevent the accumulation of explosive gas.
- Exhaust system connection. (except for SC-C0706D1)
 - Cabinet can be connected to an in-house laboratory exhaust system to efficiently exhaust the vapor inside of the cabinet.
 - Optional extraction module is also available. If your laboratory has no exhaust system at all, you can simply install this compact extraction module to the cabinet for efficient and convenient exhausting. You can experience ductless filtering acid/corrosive cabinet.



Extraction module (optional)



Built-in door lock for safe sample storage



Height-adjustable shelves and spill tray



Ergonomic designed toe space allows for easy access to the inner space



Specially designed forklift space and leveling feet for easy and stable installation



Easy arrangement and finding of each sample with pictogram sticker

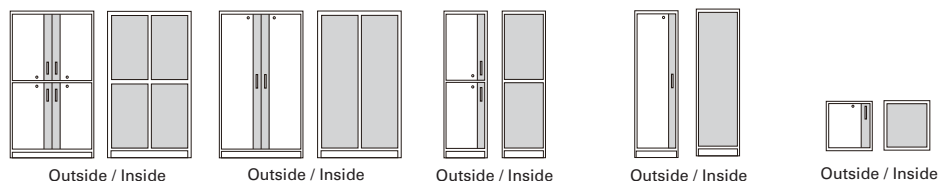

Model	SC-C1912D4	SC-C1912D2	SC-C1906D2	SC-C1906D1	SC-C0706D1	
Internal volume (L / cu ft)	213 / 7.5 x 4ea	447 / 15.9 x 2ea	213 / 7.5 x 2ea	445 / 15.7	115 / 4.1	
No. of tray (standard / max.)	8 / 12	8 / 14	4 / 6	4 / 7	1	
No. of shelf (standard / max.)	4 / 8	6 / 12	2 / 4	3 / 6	-	
Distance of between shelf (mm / inch)	120 / 4.7	100 / 3.9	130 / 5.1	100 / 3.9	-	
Max. load per shelf (kg / lbs)	80 / 176.4					
Materials	Interior	Melamine faced board				
	Exterior	Epoxy powder coated steel				
Dimension (WxDxH)	Interior (mm / inch)	561x466x818 x 4ea / 22.1x18.3x32.2 x 4ea	561x466x1712 x 2ea / 22.1x18.3x67.4 x 2ea	561x466x818 x 2ea / 22.1x18.3x32.2 x 2ea	558x466x1712 / 21.9x18.3x67.4	505x421x542 / 19.9x16.6x21.3
	Exterior (mm / inch)	1255x555x1900 / 49.4x21.9x74.8	1255x555x1900 / 49.4x21.9x74.8	655x555x1900 / 25.8x21.9x74.8	655x555x1900 / 25.8x21.9x74.8	600x510x650 / 23.6x20.1x25.6
	Spill tray (PP)	545x419x33 / 21.5x16.5x1.3				470x370x100 / 18.5x14.6x3.9
	Shelf (Melamine faced board)	552x424x18 / 21.7x16.7x0.7				-
	Net weight (kg / lbs)	284 / 626.1	257 / 566.6	160 / 352.7	146 / 321.9	52 / 114.6
Cat. No.	AAAF60043	AAAF60025	AAAF60023	AAAF60011	AAAF60012	

※ It is recommended to use with an in-house ventilation system or extraction module(EM-33) to efficiently exhaust the vapor inside of the cabinet. Using it alone may cause product durability affected from inflammable vapor stayed inside during acid/corrosive sample storage.

Accessories & Options

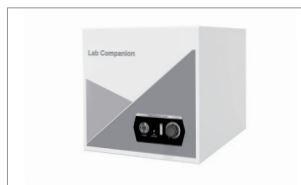

Extraction module (pre filter built-in)

Cabinet with ventilation hole can be a (ductless) filtering storage cabinet after installing this extraction module. Add suitable filters for efficient vapor extraction.



Spill Tray (polypropylene)



Shelf (Melamine faced board)

Cat. No.	Description	Suitable for
AAAF1536	EM-33, Extraction module (pre filter built in) ¹⁾ (230V, 60Hz) (348x498x343mm / 13.7x19.6x13.5inch)	SC-C1912D4, SC-C1912D2, SC-C1906D2, SC-C1906D1
AAAF15362	Plinth ²⁾ for extraction module (EM-33) (825x480x50mm / 32.5x18.9x2inch)	SC-C1912D4, SC-C1912D2
Cat. No.	Description	Application
AAAB6360	Pre filter	Larger particles and increasing the life of main filter
AAAB6353	HEPA filter	Biohazardous aerosols and other visible and non-visible particles (filtration efficiency: 99.99% at 0.3 microns)
AAAB6354	Complex carbon filter (VOC + NH ₃ + Acid)	Volatile organic compounds (VOC), Ammonia, Acidic solvents ³⁾ (MA), Alkaline solvents (MB)
AAAB6356	Acid carbon filter ³⁾	An acidic solvent ; Acetic acid, etc
AAAB6358	Formaldehyde carbon filter	Formadehyde applications
AAAB6359	Ammonia / Amines carbon filter	Ammonia/Amines by chemisorptions

1) Maximum installable filter quantity: 2 ea.

2) In case of cabinet with two ventilation holes on the top (SC-C1912D4, SC-C1912D2), plinth is required to order for connecting two holes into one. With use of plinth, you only need one extraction module (EM-33).

3) Please do not use high percentage of reactive acid such as perchloric acid.

Cat. No.	Description	Suitable for
SCF0037	Spill Tray (polypropylene) (545x419x33mm / 21.5x16.5x1.3inch)	SC-C1912D4, SC-C1912D2, SC-C1906D2, SC-C1906D1
CBN0010	Spill Tray (polypropylene) (470x370x100mm / 18.5x14.6x3.9inch)	SC-C0706D1
AAAF65302	Shelf (Melamine faced board) (552x424x18 mm / 21.7x16.7x0.7inch)	SC-C1912D4, SC-C1912D2, SC-C1906D2, SC-C1906D1

Impressive range of cabinet models to choose from for creating the most ideal lab environments. (65 Duco - Slide storage cabinet)

Manufactured with PP trays and dividers



- 8 different tray dimensions.
- Impact resistant, durable, and excellent chemical resistance rating.
- Adjustable trays can be placed at different heights.
- The tray divider keeps stuff tidy and organized.

Locking mechanism



- Adopted self-lock handle convenient for keeping things secure, comes standard with lock for protection against unauthorized users.
- Comes standard with lock for protection against unauthorized personnel.

Easily removable name plates



- Convenient and useful for keeping track of inventory.
- 3 different sizes.

3 types of color choices.



Anchoring kit

- All tall cabinets include anchoring kits to fix the cabinet to the floor to prevent the cabinet from tipping over.

Gas cylinder storage



- Gas cylinder constructed for storage of gas cylinders inside building.
- DS-GC models.
- : Essentially convenient and standard safety functions are incorporated in the cabinets.

Ventilation system

- Hexagonal or trapezoidal ventilation space is formed between the innovatively designed cabinet side structures.

Scientific Equipment and Furniture Association



- The world professional organization for providing leadership in issues involving the design, specification and utilization of laboratory furniture and equipment.

Common features for Base Cabinets

Steel base cabinets are ideally convenient on top or underneath the lab benches. Also, these cabinets come with basic exhaust structures for safe storage of routinely used laboratory items.



Fully-extendable slide out drawers useful for getting at stored lab items placed in the back of the drawer.



Superiorly chemical resistant PP trays included with the drawers keep lab material safely tidy and organized.

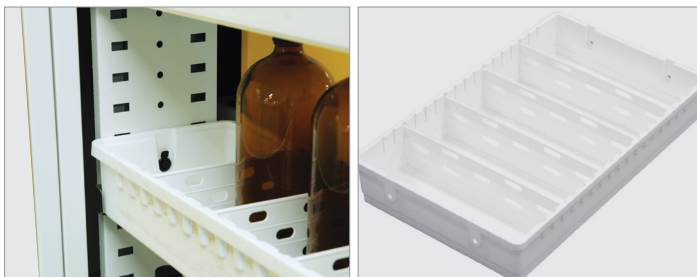

Tray comes standard with four tray dividers.

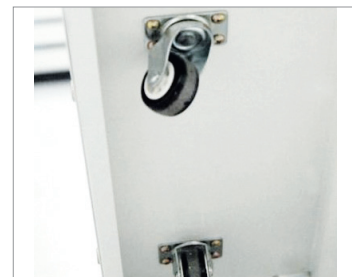

The moveable cabinets (DS-UT/DS-UD) are designed to fit under the lab bench, counter, fume hood.

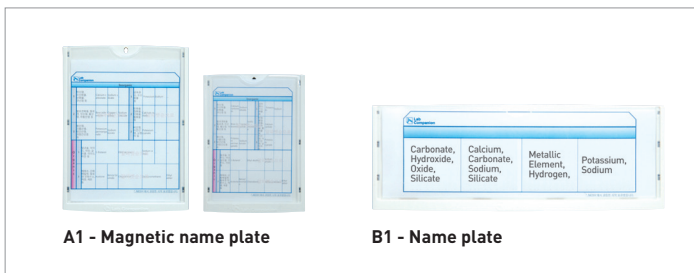

A1 - Magnetic name plate

B1 - Name plate

The removable name plate comes included with the cabinet to keep track of inventory.

ADA solutions

- DS-UT / DS-UD (only depth 550mm / 21.65inch) are made cognizant by the Americans with Disabilities Act.

General Storage Cabinet (Base - DS-TT / DS-TW)

Table top cabinets

Glass door cabinets and pull-out drawers can also be used as a table top storage unit.

DS-TT

Standard accessories

- Trays, Tray dividers
- Name plates, Door key

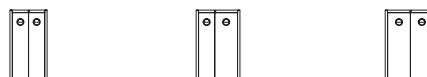
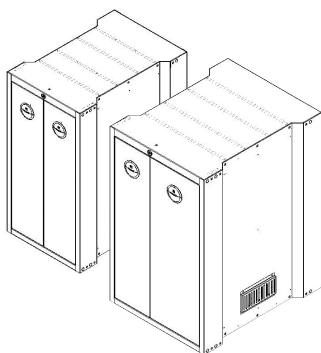

Exterior height (mm / inch)	900 / 35.4	900 / 35.4	900 / 35.4
Exterior width (mm / inch)	476 / 18.7	560 / 22.1	644 / 25.4
Each drawer width (mm / inch)	Left	194 / 7.6	278 / 10.9
	Right	194 / 7.6	278 / 10.9
No. of tray (standard / max.)	3 / 4	3 / 4	3 / 4
Max. load per tray (kg / lbs)	30 / 66.1	30 / 66.1	30 / 66.1
No. of name plate	2	2	2
Exterior depth (mm / inch)	700 / 27.6	700 / 27.6	700 / 27.6
Net weight (kg / lbs)	61 / 134.5	67 / 147.7	73 / 160.9
Model	DS-TT-09047D2	DS-TT-09056D2	DS-TT-09064D2
Cat. No.	AAAF1020	AAAF1021	AAAF1022
Exterior depth (mm / inch)	550 / 21.6	550 / 21.6	550 / 21.6
Net weight (kg / lbs)	54 / 119.0	59 / 130.1	64 / 141.1
Model	DS-TT-09047N2	DS-TT-09056N2	DS-TT-09064N2
Cat. No.	AAAF1023	AAAF1024	AAAF1025

DS-TW

Standard accessories

- Trays, Tray dividers, Name plates

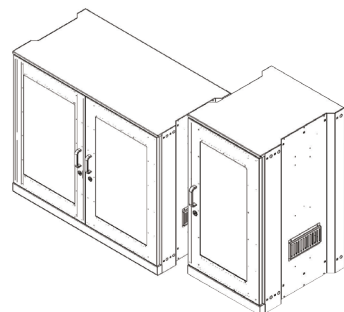

Exterior height (mm / inch)	900 / 35.4	900 / 35.4	900 / 35.4	900 / 35.4
Exterior width (mm / inch)	472 / 18.6	556 / 21.9	915 / 36.0	1083 / 42.6
Each drawer width (mm / inch)	418 / 16.5	502 / 19.8	418 / 16.5	502 / 19.8
No. of tray (standard / max.)	3 / 4	3 / 4	3 / 4	3 / 4
Max. load per tray (kg / lbs)	30 / 66.1	30 / 66.1	30 / 66.1	30 / 66.1
No. of name plate	2	2	2	2
Exterior depth (mm / inch)	550 / 21.6	550 / 21.6	550 / 21.6	550 / 21.6
Net weight (kg / lbs)	61 / 134.5	65 / 143.3	110 / 242.5	119 / 262.4
Model	DS-TW-09047N1	DS-TW-09055N1	DS-TW-09091N2	DS-TW-09108N2
Cat. No.	AAAF1054	AAAF1055	AAAF1056	AAAF1057

Accessories & Options

Cat. No.	Description	Suitable for
CBN0014	Tray (160x620x80mm / 6.3x24.4x3.1")	DS-TT-09047D2, 09056D2
CBN0015	Tray (250x620x90mm / 9.8x 24.4x3.5")	
CBN0008	Tray (160x470x80mm / 6.3x18.5x3.1")	
CBN0009	Tray (250x470x90mm / 9.8x18.5x3.5")	
AAAF1501	Drawer set (epoxy painted steel, 388x504mm / 15.3x19.8")	DS-TW-09047N1, 09091N2
AAAF1502	Drawer set (epoxy painted steel, 472x504mm / 18.6x19.8")	
AAAF1504	Drawer set (stainless steel, 388x504mm / 15.3x19.8")	
AAAF1505	Drawer set (stainless steel, 472x504mm / 18.6x9.8")	
CBN0016	Tray divider (160mm / 6.3" width)	DS-TT-09047D2, 09056D2, 09047N2, 09056N2
CBN0017	Tray divider (250mm / 9.8" width)	
CBN0018	Tray divider (370mm / 14.6" width)	DS-TW-09047N1, 09091N2
CBN0019	Tray divider (450mm / 17.7" width)	
AAAF1521	Magnetic name plate A1 (150x200mm / 5.9x7.9")	DS-TT-09047D2, 09056D2, 09064D2, 09047N2, 09056N2, 09064N2
AAAF1523	Name plate B1 (320x115mm / 12.6x4.5")	DS-TW-09047N1, 09091N2, 09055N1, 09108N2

Under table type cabinets

Movable and compact storage units useful for underneath the lab bench.

DS-UT

Standard accessories

- Trays, Tray dividers
- Name plates, Door key

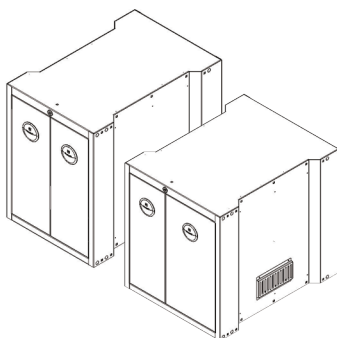

Exterior height (mm / inch)	650 / 25.6	650 / 25.6	650 / 25.6
Exterior width (mm / inch)	476 / 18.7	560 / 22.1	644 / 25.4
Each drawer width (mm / inch)	Left	194 / 7.6	278 / 10.9
	Right	194 / 7.6	278 / 10.9
No. of tray (standard / max.)	3 / 3	3 / 3	3 / 3
Max. load per tray (kg / lbs)	30 / 66.1	30 / 66.1	30 / 66.1
No. of name plate	2	2	2
Exterior depth (mm / inch)	700 / 27.6	700 / 27.6	700 / 27.6
Net weight (kg / lbs)	58 / 127.9	64 / 141.1	70 / 154.3
Model	DS-UT-06047D2	DS-UT-06056D2	DS-UT-06064D2
Cat. No.	AAAF1010	AAAF1011	AAAF1012
Exterior depth (mm / inch)	550 / 21.6	550 / 21.6	550 / 21.6
Net weight (kg / lbs)	50 / 110.2	55 / 121.3	60 / 132.3
Model	DS-UT-06047N2	DS-UT-06056N2	DS-UT-06064N2
Cat. No.	AAAF1013	AAAF1014	AAAF1015

DS-UD

Standard accessories

- Trays, Tray dividers
- Name plates, Door key

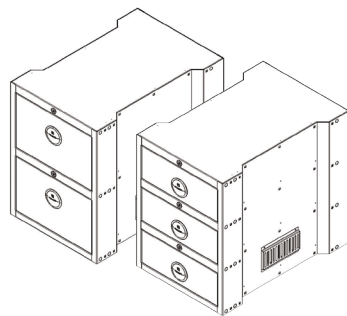

Exterior height (mm / inch)	650 / 25.6	650 / 25.6	650 / 25.6	650 / 25.6
Exterior width (mm / inch)	476 / 18.7	476 / 18.7	560 / 22.1	560 / 22.1
Each drawer width (mm / inch)	388 / 15.3	388 / 15.3	472 / 18.6	472 / 18.6
No. of tray (standard / max.)	1 / 1	1 / 1	1 / 1	1 / 1
Max. load per tray (kg / lbs)	30 / 66.1	30 / 66.1	30 / 66.1	30 / 66.1
No. of name plate	2	3	2	3
Exterior depth (mm / inch)	700 / 27.6	700 / 27.6	700 / 27.6	700 / 27.6
Net weight (kg / lbs)	50 / 110.2	61 / 134.5	57 / 125.7	69 / 152.1
Model	DS-UD-06047D2	DS-UD-06047D3	DS-UD-06056D2	DS-UD-06056D3
Cat. No.	AAAF1040	AAAF1041	AAAF1042	AAAF1043
Exterior depth (mm / inch)	550 / 21.6	550 / 21.6	550 / 21.6	550 / 21.6
Net weight (kg / lbs)	43 / 94.8	52 / 114.6	49 / 108	59 / 130
Model	DS-UD-06047N2	DS-UD-06047N3	DS-UD-06056N2	DS-UD-06056N3
Cat. No.	AAAF1044	AAAF1045	AAAF1046	AAAF1047

Accessories & Options

Cat. No.	Description	Suitable for	
CBN0014	Tray (160×620×80mm / 6.3×24.4×3.1")	DS-UT-	06047D2, 06056D2
CBN0015	Tray (250×620×90mm / 9.8×24.4×3.5")		06056D2, 06064D2
CBN0008	Tray (160×470×80mm / 6.3×18.5×3.1")		06047N2, 06056N2
CBN0009	Tray (250×470×90mm / 9.8×18.5×3.5")		06056N2, 06064N2
CBN0012	Tray (370×620×100mm / 14.6×24.4×3.9")	DS-UD-	06047D2, 06047D3
CBN0013	Tray (450×620×110mm / 17.7×24.4×4.3")		06056D2, 06056D3
CBN0010	Tray (370×470×100 / 14.6×18.5×3.9")		06047N2, 06047N3
CBN0011	Tray (450×470×110 / 17.7×18.5×4.3")		06056N2, 06056N3
CBN0016	Tray divider (160mm / 6.3" width)	DS-UT-	06047D2, 06056D2, 06047N2, 06056N2
CBN0017	Tray divider (250mm / 9.8" width)		06056D2, 06064D2, 06056N2, 06064N2
CBN0018	Tray divider (370mm / 14.6" width)	DS-UD-	06047D2, 06047D3, 06047N2, 06047N3
CBN0019	Tray divider (450mm / 17.7" width)		06056D2, 06056D3, 06056N2, 06056N3
AAAF1521	Magnetic name plate A1 (150×200mm / 5.9×7.9")	DS-UT-	06047D2, 06056D2, 06064D2, 06047N2, 06056N2, 06064N2
AAAF1522	Magnetic name plate A2 (120×165mm / 4.7×6.5")	DS-UD-	06047D2, 06056D2, 06047N2, 06056N2
		DS-UD-	06047D3, 06056D3, 06047N3, 06056N3

General Storage Cabinet (Tall)

Common features for Tall Cabinets

Tall cabinet models are useful for storing large amounts of liquid and solid substances.



The fully extendable drawers can be accessed from either left or right side of the cabinets.



Hidden wheels under the lower drawer for DS-SL and DS-S models easily support 60kg.



Connect multiple cabinets side by side to make the cabinets sturdy and balanced.

The air and vapor vented through both sides of the cabinet vent slits.



The removable name plates come included for keeping track of inventory.

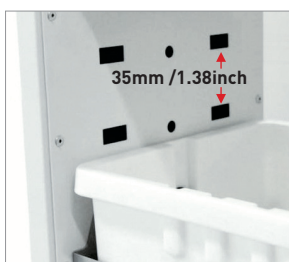

Adjustable bracket mounts in the cabinet, designed for placing PP trays at any height.



Each tray comes standard with four tray dividers.



Anchor
Four anchors are provided for ensuring the cabinet safely fixed on the floor.

Cat. No.	Description
CBN0036	Anchor



Extraction module (optional)
(except for DS-OR)

Cabinet with ventilation hole can be a (ductless) filtering storage cabinet after installing this extraction module. Add suitable filters for efficient vapor extraction.

Cat. No.	Description
AAAF1536	EM-33, Extraction module (pre filter built in) ¹⁾ (230V, 60Hz) (348x498x343mm / 13.7x19.6x13.5inch)
Cat. No.	Description
AAAB6360	Pre filter
AAAB6353	HEPA filter
AAAB6354	Complex carbon filter (VOC + NH ₃ + Acid)
AAAB6356	Acid carbon filter ²⁾
AAAB6358	Formaldehyde carbon filter
AAAB6359	Ammonia / Amines carbon filter

1) Maximum installable filter quantity: 2 ea.

2) Please do not use high percentage of reactive acid such as perchloric acid.



Stand type cabinets

Large and tall dimensions with 3 tier pull-out storage drawers.

Cabinet can be either connected to in-house laboratory exhaust system or extraction module (optional, see page 52) in order to efficiently exhaust the vapor inside of the cabinet.

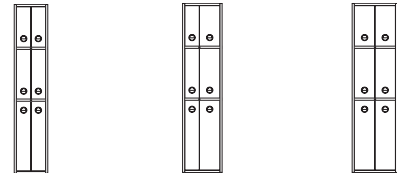

DS-SL

Standard accessories

- Trays, Tray dividers
- Name plates, Anchors, Door key

Optional accessories

- Extraction module

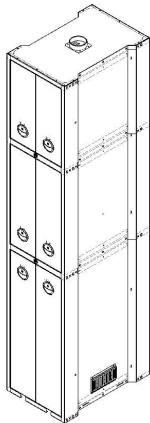

Exterior height (mm / inch)		2400 / 94.5	2400 / 94.5	2400 / 94.5
Exterior width (mm / inch)		476 / 18.7	560 / 22.0	644 / 26.1
Each drawer width (mm / inch)	Left	194 / 7.6	194 / 7.6	278 / 10.9
	Right	194 / 7.6	278 / 10.9	278 / 10.9
No. of tray (standard / max.)	Upper	3 / 3	3 / 3	3 / 3
	Middle	3 / 4	3 / 4	3 / 4
	Lower	4 / 6	4 / 6	4 / 6
Max. load per tray (kg / lbs)	Upper, Middle	30 / 66.1	30 / 66.1	30 / 66.1
	Lower	60 / 132.3	60 / 132.3	60 / 132.3
No. of name plate		6	6	6
Exterior depth (mm / inch)		700 / 27.6	700 / 27.6	700 / 27.6
Net weight (kg / lbs)		181 / 399.0	196 / 432.1	212 / 467.4
Model		DS-SL-24047D6	DS-SL-24056D6	DS-SL-24064D6
Cat. No.		AAAF1080	AAAF1081	AAAF1082

Accessories & Options

Trays

Cat. No.	Description	Suitable for
CBN0014	Tray (160×620×80mm / 6.3×24.4×3.1")	DS-SL- 24047D6, 24056D6 24056D6, 24064D6
CBN0015	Tray (250×620×90mm / 9.8× 24.4×3.5")	

Tray dividers

Cat. No.	Description	Suitable for
CBN0016	Tray divider (160mm / 6.3" width)	DS-SL- 24047D6, 24056D6 24056D6, 24064D6
CBN0017	Tray divider (250mm / 9.8" width)	

Name plates

Cat. No.	Description	Suitable for
AAAF1521	Magnetic name plate A1 (150×200mm / 5.9×7.9")	DS-SL- 24047D6, 24056D6, 24064D6

General Storage Cabinet (Tall - DS-S)



Stand type cabinets

General height with 2 tier pull-out storage drawers.

Cabinet can be either connected to in-house laboratory exhaust system or extraction module (optional, see page 52) in order to efficiently exhaust the vapor inside of the cabinet.

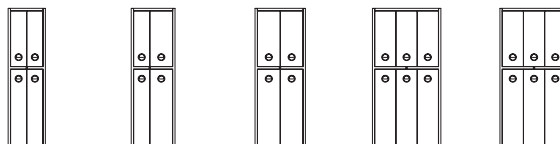

DS-S

Standard accessories

- Trays, Tray dividers
- Name plates, Anchors, Door key

Optional accessories

- Extraction module

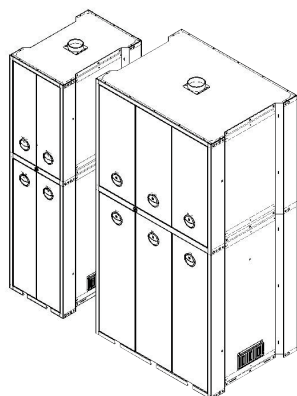

Exterior height (mm / inch)	1800 / 70.9	1800 / 70.9	1800 / 70.9	1800 / 70.9	1800 / 70.9
Exterior width (mm / inch)	476 / 18.7	560 / 22.1	644 / 25.4	686 / 27.0	938 / 36.9
Each drawer width (mm / inch)	Left	194 / 7.6	194 / 7.6	278 / 10.9	194 / 7.6
	Middle	-	-	-	194 / 7.6
	Right	194 / 7.6	278 / 10.9	278 / 10.9	194 / 7.6
No. of tray (standard / max.)	Upper	3 / 4	3 / 4	3 / 4	3 / 4
	Lower	4 / 6	4 / 6	4 / 6	4 / 6
Max. load per tray (kg / lbs)	Upper	30 / 66.1	30 / 66.1	30 / 66.1	30 / 66.1
	Lower	60 / 132.3	60 / 132.3	60 / 132.3	60 / 132.3
No. of name plate	4	4	4	6	6
Exterior depth (mm / inch)	700 / 27.6	700 / 27.6	700 / 27.6	700 / 27.6	700 / 27.6
Net weight (kg / lbs)	124 / 273.4	137 / 302.0	146 / 321.9	172 / 379.2	206 / 454.2
Model	DS-S-18047D4	DS-S-18056D4	DS-S-18064D4	DS-S-18068D6	DS-S-18093D6
Cat. No.	AAAF1000	AAAF1001	AAAF1002	AAAF1003	AAAF1004
Exterior depth (mm / inch)	550 / 21.6	550 / 21.6	550 / 21.6	550 / 21.6	550 / 21.6
Net weight (kg / lbs)	107 / 235.9	119 / 262.4	126 / 277.8	148 / 326.3	178 / 392.4
Model	DS-S-18047N4	DS-S-18056N4	DS-S-18064N4	DS-S-18068N6	DS-S-18093N6
Cat. No.	AAAF1005	AAAF1006	AAAF1007	AAAF1008	AAAF1009

Accessories & Options

Trays

Cat. No.	Description	Suitable for
CBN0014	Tray (160x620x80mm / 6.3x24.4x3.1")	DS-S- 18047D4, 18056D4, 18068D6 18056D4, 18064D4, 18093D6 18047N4, 18056N4, 18068N6 18056N4, 18064N4, 18093N6
CBN0015	Tray (250x620x90mm / 9.8x 24.4x3.5")	
CBN0008	Tray (160x470x80mm / 6.3x18.5x3.1")	
CBN0009	Tray (250x470x90mm / 9.8x18.5x3.5")	

Tray dividers

Cat. No.	Description	Suitable for
CBN0016	Tray divider (160mm / 6.3" width)	DS-S- 18047D4, 18056D4, 18068D6, 18047N4, 18056N4, 18068N6 18056D4, 18064D4, 18093D6, 18056N4, 18064N4, 18093N6
CBN0017	Tray divider (250mm / 9.8" width)	

Name plates

Cat. No.	Description	Suitable for
AAAF1521	Magnetic name plate A1 (150x200mm / 5.9x7.9")	DS-S- 18047D4, 18056D4, 18068D6, 18064D4, 18093D6, 18047N4, 18056N4, 18068N6, 18064N4, 18093N6



Combi type cabinets

Variety of different size drawers, narrow and wide.

Cabinet can be either connected to in-house laboratory exhaust system or extraction module (optional, see page 52) in order to efficiently exhaust the vapor inside of the cabinet.

DS-C

Standard accessories

- Trays, Tray dividers
- Name plates, Anchors, Door key

Optional accessories

- Extraction module



Exterior height (mm / inch)		1800 / 70.9	1800 / 70.9	1800 / 70.9	1800 / 70.9
Exterior width (mm / inch)		476 / 18.7	476 / 18.7	560 / 22.1	560 / 22.1
Each drawer width (mm / inch)	Left	194 / 7.6	194 / 7.6	194 / 7.6	194 / 7.6
	Right	194 / 7.6	194 / 7.6	278 / 10.9	278 / 10.9
No. of tray (standard / max.)	Upper	3 / 4	3 / 4	3 / 4	3 / 4
	Lower	1 / 1	1 / 1	1 / 1	1 / 1
Max. load per tray (kg / lbs)		30 / 66.1	30 / 66.1	30 / 66.1	30 / 66.1
No. of name plate		4	5	4	5
Exterior depth (mm / inch)		700 / 27.6	700 / 27.6	700 / 27.6	700 / 27.6
Net weight (kg / lbs)		114 / 251.3	126 / 277.8	127 / 279.9	140 / 380.6
Model		DS-C-18047D4	DS-C-18047D5	DS-C-18056D4	DS-C-18056D5
Cat. No.		AAAF1030	AAAF1031	AAAF1032	AAAF1033
Exterior depth (mm / inch)		550 / 21.6	550 / 21.6	550 / 21.6	550 / 21.6
Net weight (kg / lbs)		100 / 220.5	108 / 238.1	110 / 242.5	120 / 264.6
Model		DS-C-18047N4	DS-C-18047N5	DS-C-18056N4	DS-C-18056N5
Cat. No.		AAAF1034	AAAF1035	AAAF1036	AAAF1037

Accessories & Options

Trays

Cat. No.	Description	Suitable for	
CBN0014	Tray (160x620x80mm / 6.3x24.4x3.1")	DS-C-	
CBN0015	Tray (250x620x90mm / 9.8x24.4x3.5")		
CBN0012	Tray (370x620x100mm / 14.6x24.4x3.9")		
CBN0013	Tray (450x620x110mm / 17.7x24.4x4.3")		
CBN0008	Tray (160x470x80mm / 6.3x18.5x3.1")		
CBN0009	Tray (250x470x90mm / 9.8x18.5x3.5")		
CBN0010	Tray (370x470x100 / 14.6x18.5x3.9")		
CBN0011	Tray (450x470x110 / 17.7x18.5x4.3")		
			18047D4, 18047D5, 18056D4, 18056D5
			18056D4, 18056D5
			18047D4, 18047D5
		18056D4, 18056D5	
		18047N4, 18047N5, 18056N4, 18056N5	
		18056N4, 18056N5	
		18047N4, 18047N5	
		18056N4, 18056N5	

Tray dividers

Cat. No.	Description	Suitable for
CBN0016	Tray divider (160mm / 6.3" width)	DS-C-
CBN0017	Tray divider (250mm / 9.8" width)	
CBN0018	Tray divider (370mm / 14.6" width)	
CBN0019	Tray divider (450mm / 17.7" width)	
		18047D4, 18047D5, 18056D4, 18056D5, 18047N4, 18047N5, 18056N4, 18056N5
		18056D4, 18056D5, 18056N4, 18056N5
		18047D4, 18047D5, 18047N4, 18047N5
		18056D4, 18056D5, 18056N4, 18056N5

Name plates

Cat. No.	Description	Suitable for
AAAF1521	Magnetic name plate A1 (150x200mm / 5.9x7.9")	DS-C-
AAAF1522	Magnetic name plate A2 (120x165mm / 4.7x6.5")	
		18047D4, 18047D5, 18056D4, 18056D5, 18047N4, 18047N5, 18056N4, 18056N5
		18047D5, 18056D5, 18047N5, 18056N5

General Storage Cabinet (Tall - DS-OW / DS-OR)



Open window type cabinet / Open rack type cabinets

Tempered glass cabinet door allow for easy viewing. (DS-OW)

- Cabinet can be either connected to in-house laboratory exhaust system or extraction module (optional, see page 52) in order to efficiently exhaust the vapor inside of the cabinet.

Multipurpose and stationary storage units. (DS-OR)

DS-OW

Standard accessories

- Trays, Tray dividers
- Name plates, Anchors, Door key

Optional accessories

- Extraction module

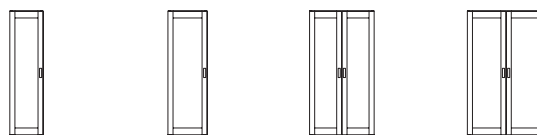
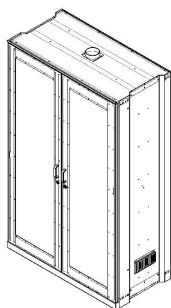

Exterior height (mm / inch)	1800 / 70.9	1800 / 70.9	1800 / 70.9	1800 / 70.9
Exterior width (mm / inch)	472 / 18.6	556 / 21.9	915 / 36.0	1083 / 42.6
Each drawer width (mm / inch)	418 / 16.5	502 / 19.8	418 / 16.5	502 / 19.8
No. of tray (standard / max.)	6 / 11	6 / 11	12 / 22	12 / 22
Max. load per tray (kg / lbs)	30 / 66.1	30 / 66.1	30 / 66.1	30 / 66.1
No. of name plate	6	6	12	12
Exterior depth (mm / inch)	550 / 21.6	550 / 21.6	550 / 21.6	550 / 21.6
Net weight (kg / lbs)	124 / 273.4	137 / 302.0	146 / 321.9	172 / 379.2
Model	DS-OW-18047N1	DS-OW-18055N1	DS-OW-18091N2	DS-OW-18108N2
Cat. No.	AAAF1050	AAAF1051	AAAF1052	AAAF1053

DS-OR

Standard accessories

- Trays, Tray dividers, Anchors

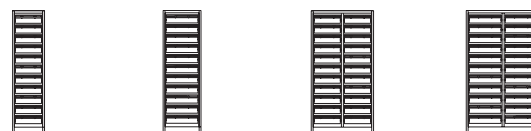
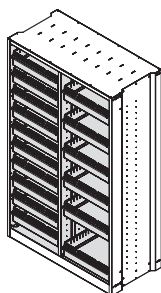

Exterior height (mm / inch)	1800 / 70.9	1800 / 70.9	1800 / 70.9	1800 / 70.9
Exterior width (mm / inch)	472 / 18.6	556 / 21.9	915 / 36.0	1083 / 42.6
Each drawer width (mm / inch)	418 / 16.5	502 / 19.8	418 / 16.5	502 / 19.8
No. of tray (standard / max.)	11 / 11	11 / 11	22 / 22	22 / 22
Max. load per tray (kg / lbs)	30 / 66.1	30 / 66.1	30 / 66.1	30 / 66.1
Exterior depth (mm / inch)	550 / 21.6	550 / 21.6	550 / 21.6	550 / 21.6
Net weight (kg / lbs)	110 / 242.5	120 / 264.6	215 / 473.9	244 / 537.9
Model	DS-OR-18047N1	DS-OR-18055N1	DS-OR-18091N2	DS-OR-18108N2
Cat. No.	AAAF1090	AAAF1091	AAAF1092	AAAF1093

Accessories & Options

Cat. No.	Description	Suitable for
AAAF1501	Drawer set (epoxy painted steel, 388x504mm / 15.3x19.8")	18047N1, 18091N2
AAAF1502	Drawer set (epoxy painted steel, 472x504mm / 18.6x19.8")	18055N1, 18108N2
AAAF1504	Drawer set (stainless steel, 388x504mm / 15.3x19.8")	18047N1, 18091N2
AAAF1505	Drawer set (stainless steel, 472x504mm / 18.6x19.8")	18055N1, 18108N2
AAAF1507	Drawer set (epoxy painted steel, 388x504mm / 15.3x19.8")	18047N1, 18091N2
AAAF1508	Drawer set (epoxy painted steel, 472x504mm / 18.6x19.8")	18055N1, 18108N2
AAAF1509	Drawer set (stainless steel, 388x504mm / 15.3x19.8")	18047N1, 18091N2
AAAF1510	Drawer set (stainless steel, 472x504mm / 18.6x19.8")	18055N1, 18108N2
CBN0018	Tray divider (370mm / 14.6" width)	18047N1, 18091N2
CBN0019	Tray divider (450mm / 17.7" width)	18055N1, 18108N2
CBN0018	Tray divider (370mm / 14.6" width)	18047N1, 18091N2
CBN0019	Tray divider (450mm / 17.7" width)	18055N1, 18108N2
AAAF1523	Name plate B1 (320x115mm / 12.6x4.5")	18047N1, 18055N1, 18091N2, 18108N2

Constructed progressively strong, and for storage of gas cylinders inside of buildings.

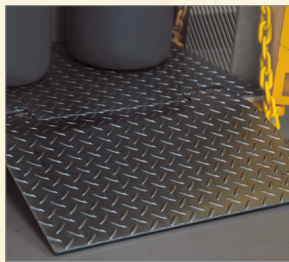

Large interior

Wide fold down ramp, safe and easy to maneuver gas cylinders in and out of the cabinet, easy to install gas fittings and pipes.



Spark-proof plastic chains

Convenient for securing gas cylinders in place, prevents gas cylinders from getting scratched.

Front and both side vent slits vents the cabinet effectively disperses the gas leak out of the cabinet in case there is damage to one of the gas cylinders.

DS-GC

Standard accessories

- Door key

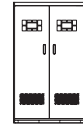
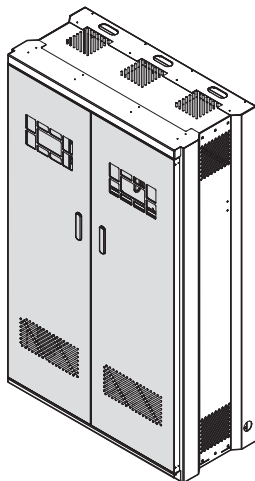

Exterior height (mm / inch)	1800 / 70.9	1800 / 70.9
Exterior width (mm / inch)	740 / 29.1	1070 / 42.1
Max. storage capacity of Ø230mm gas cylinder	2	3
Exterior depth (mm / inch)	550 / 21.6	550 / 21.6
Net weight (kg / lbs)	107 / 235.9	140 / 308.6
Model	DS-GC-18074N2	DS-GC-18107N2
Cat. No.	AAAF1070	AAAF1071