

Elcometer 1720

Abrasion Tester

Abrasion and Washability Tester

Operating Instructions



CE The product is Class A, Group 1 ISM equipment according to CISPR 11
Group 1 ISM product: A product in which there is intentionally generated and/or used conductively coupled radio-frequency energy which is necessary for the internal functioning of the equipment itself.

Class A product are suitable for use in all establishments other than domestic and those directly connected to a low voltage power supply network which supplies buildings used for domestic purposes.

The Elcometer 1720 Tester meets the Electromagnetic Compatibility and Machinery Directives.

elcometer® is a registered trademark of Elcometer Limited.

Material Safety Data Sheets for the scrub media available as an accessory for the Elcometer 1720 are available to download via our website:

Elcometer 1720 Scrub Media SC-1 and SC-2

http://www.elcometer.com/images/MSDS/elcometer_1720_scrub_media.pdf

Elcometer 1720 Scrub Media ST-1

http://www.elcometer.com/images/MSDS/elcometer_1720_scrub_media_st1.pdf

All other trademarks acknowledged. © Copyright Elcometer Limited. 2009/2013.

All rights reserved. No part of this Document may be reproduced, transmitted, transcribed, stored (in a retrieval system or otherwise) or translated into any language, in any form or by any means (electronic, mechanical, magnetic, optical, manual or otherwise) without the prior written permission of Elcometer Limited.

A copy of this Instruction Manual is available for download on our Website via www.elcometer.com.

CONTENTS

| Section | Page |
|--|-----------|
| 1 About your tester | 2 |
| 1.1 These instructions | 2 |
| 1.2 Standards | 2 |
| 1.3 What the box contains | 3 |
| 1.4 Packaging | 3 |
| 2 Getting started | 4 |
| 2.1 Caution | 4 |
| 2.2 The parts of your tester | 4 |
| 2.3 Access panel | 5 |
| 2.4 Power input and main on/off switch | 5 |
| 2.5 The control panel | 6 |
| 3 Configuring your tester | 7 |
| 4 The display | 8 |
| 4.1 Display - during operation | 8 |
| 4.2 Display - error | 9 |
| 4.3 Display - menus | 10 |
| 5 Testing a specimen | 11 |
| 6 Tools | 13 |
| 6.1 For Elcometer 1720 Abrasion and Elcometer 1720 Abrasion & Washability Testers | 13 |
| 7 Adjusting stroke length of the carriage | 15 |
| 8 Special tests | 16 |
| 8.1 Testing Resistance of Markings | 16 |
| 8.2 EN 607301-1 | 16 |
| 8.3 Testing fabrics using the 'Crockmeter' | 17 |
| 9 Maintenance | 17 |
| 9.1 Lubricate the carriage mechanism | 18 |
| 9.2 Check the pumping system | 20 |
| 9.3 Check conformity to standards | 20 |
| 9.4 Reconditioning nylon brushes (Tool 2, ASTM 2486) | 20 |
| 9.5 Faults | 21 |
| 10 Technical specification | 21 |
| 11 Spare parts and accessories | 22 |
| 12 Related equipment | 23 |

Thank you for purchasing this Elcometer 1720 Tester. Welcome to Elcometer.

Elcometer are world leaders in the design, manufacture and supply of inspection equipment for coatings and concrete. Our products cover all aspects of coating inspection, from development through application to post application inspection.

The Elcometer 1720 Tester, is a world-beating product. With the purchase of this product you now have access to the worldwide service and support network of Elcometer. For more information visit our website at www.elcometer.com

1 ABOUT YOUR TESTER

The Elcometer 1720 Tester is a robust, reliable and extremely flexible machine. The machine enables testing to be carried out on a wide range of materials including; paint, lacquers, inks, coatings, leather, wood, plastics, printed material, fabrics, etc.

All test tools are held in a carriage which moves back and forth over a specimen of the material being tested. Stroke length and speed of the carriage are adjustable.

The number of cycles per test is adjustable. When the set number of cycles has been completed, the tester stops automatically. A separate counter records the total number of cycles performed by the tester.

Some versions of the tester include a liquid reservoir and pump which will provide an adjustable dose of liquid per cycle if required.

1.1 These instructions

These instructions describe the operation of the following Elcometer 1720 models:

- Elcometer 1720 Abrasion Tester - 2 lane model
- Elcometer 1720 Abrasion Tester - 4 lane model
- Elcometer 1720 Abrasion and Washability Tester - 2 lane model
- Elcometer 1720 Abrasion and Washability Tester - 4 lane model

1.2 Standards

Depending upon model, the Elcometer 1720 can be used in accordance with the following National and International Standards: AS/NZS 1580.459.1, ASTM D 2486, ASTM D 4213:92, ASTM D 4213, ASTM D 3450, ASTM D 4488, ASTM D 4828, ASTM F 1319, DIN 53778-2:83, ECCA T11, EN 13523-11, EN60730-1- A, GME 60269, ISO 105-X12, ISO 11998, Renault/PSA D45 1010.

1.3 What the box contains

- Elcometer 1720 Abrasion Tester (2 lane or 4 lane model), or Elcometer 1720 Abrasion and Washability Tester (2 lane or 4 lane model)
- Metal strip, thickness 250 µm (10 mil) - for ASTM D2486 standard
- Sample Drip Tray
- 1x Glass sheet (2 lane); 2x Glass sheet (4 lane)
- 1x Specimen holding frame (2 lane); 2x Specimen holding frame (4 lane)
- Liquid dosing bottle (not supplied with models M202 and M204)
- Liquid delivery pipe (not supplied with models M202 and M204)
- 2 x Liquid drain pipe (not supplied with models M202 and M204)
- Screwdriver, T-Bar and Hexagonal Wrench for instrument setup (behind access cover at rear of tester)
- Operating instructions

Tools are not supplied as standard and must be ordered separately. For the complete range of tools available, see "Tools" on page 13.

1.4 Packaging

The Elcometer 1720 Tester is packed in a cardboard, wood and foam package. Please ensure that this packaging is disposed of in an environmentally sensitive manner. Consult your local Environmental Authority for further guidance.

To maximise the benefits of your new Elcometer 1720 please take some time to read these Operating Instructions. Do not hesitate to contact Elcometer or your Elcometer supplier if you have any questions.

2 GETTING STARTED

2.1 Caution



The Elcometer 1720 has been manufactured with your safety in mind. However, improper use can result in damage to the tester. Please observe the precautions discussed in these operating instructions.

To reduce the risk of electric shock do not open the housing of the tester. There are no user-serviceable parts inside. To reduce the risk of fire or electric shock, do not expose the tester to rain or excess moisture.

The tester is very heavy - see “Technical specification” on page 21:

- Manual lifting of the tester must be carried out by at least two people.
- The tester must be placed on a flat level bench suitable for the load imposed by the tester.

The tester must be plugged into a suitably rated mains switched socket outlet. The disconnect device of the tester is the plug and mains socket and these must be readily accessible to the user.

The mains plug on your Elcometer 1720 may be fitted with a fuse. When replacing this fuse, ensure a fuse of the correct rating is used.

2.2 The parts of your tester

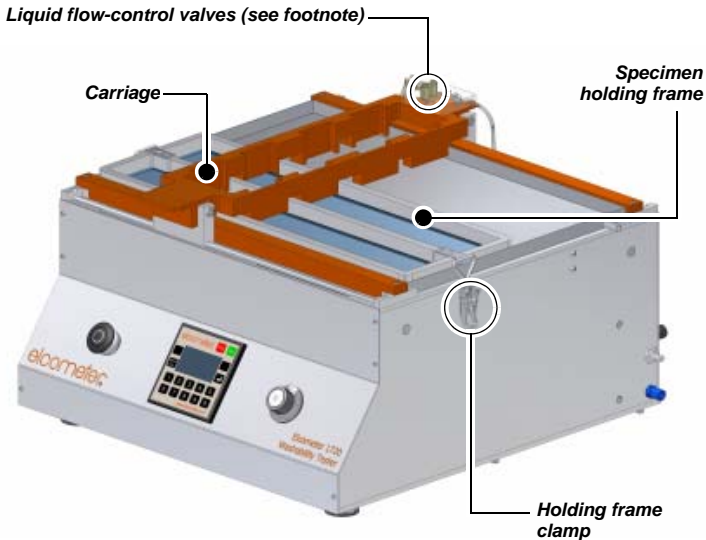

Figure 1. Parts of the tester (Abrasion and Washability Tester, 2 lane model)^a

a. Liquid flow-control valves are not fitted to models M202 and M204.

2.3 Access panel

A removable panel at the rear of the tester gives access to the pump, the power input socket and the tools (Figure 2). To remove the panel, unscrew the thumbscrew at either side of the panel.

Note: The pump and associated pipework is only fitted to the following Elcometer 1720 model:

- Abrasion and Washability Tester

The Elcometer 1720 Abrasion Tester is not fitted with a pump or pipework.

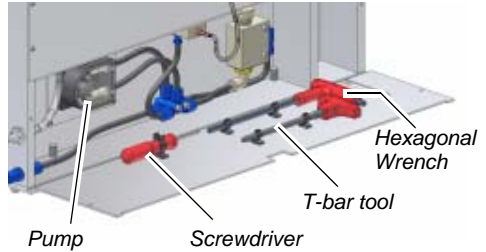

Figure 2. Pump, tools and power input behind access cover

2.4 Power input and main on/off switch

The power input socket is located behind the access panel at the rear of the tester (Figure 3). A fuse protects the power input socket - see “Technical specification” on page 21 for fuse rating.

The mains on/off switch is on the side of the tester.



Figure 3. Power input socket, fuse and mains on/off switch

2.5 The control panel

The tester is operated using the controls (Figure 4) mounted on the front panel of the machine.

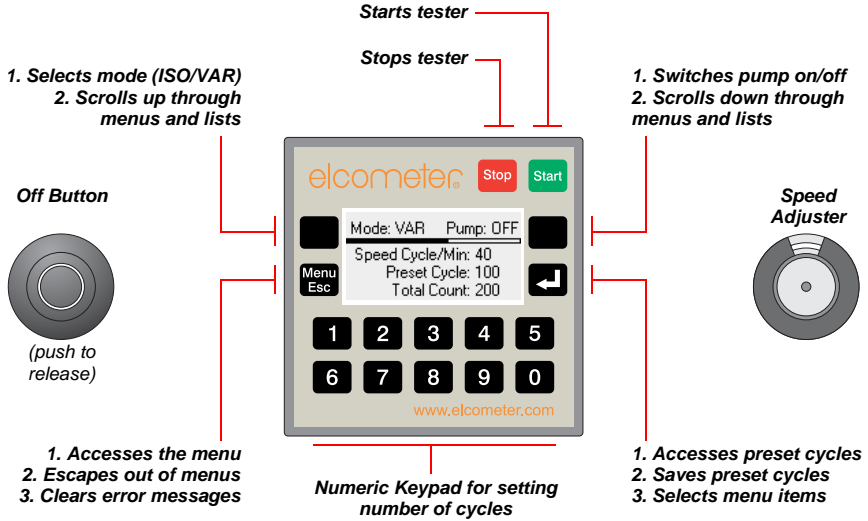
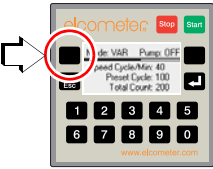

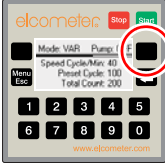

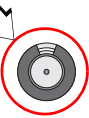
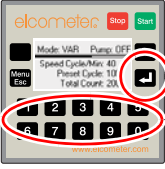





Figure 4. Control panel

Note: The above display shows 'Pump: OFF' and 'Mode: VAR' These features and their associated control button functions are not available on Elcometer 1720 Abrasion Tester models.

3 CONFIGURING YOUR TESTER

Your tester is configured using the keypad and controls on the front of the machine. The following four parameters can be adjusted:

| Parameter | Options | To adjust parameter, use this control... |
|-------------------------|--|--|
| Mode^a | VAR (variable speed) or ISO (fixed speed - 37 cycles per minute) Note: ISO mode is used for ASTM, DIN and ISO test methods |   |
| Pump^b | ON or OFF |   |
| Speed Cycle/Min | Carriage speed (cycles per minute). Note: This parameter cannot be adjusted when mode is set to ISO. |   |
| Preset Cycles | Number of complete back and forth cycles of the carriage during a test. |  <p>(Press , use the numeric keypad to enter the number of cycles and then press  again)</p>  |

- a. Mode parameter is not available on Elcometer 1720 Abrasion Tester models
- b. Pump parameter is not available on Elcometer 1720 Abrasion Tester models

4 THE DISPLAY

The contents of the display vary according to which mode has been selected (ISO or VAR) and whether the menus are displayed.

Note: The 'Pump' and 'Mode' parameters are not available on Elcometer 1720 Abrasion Tester models.

4.1 Display - during operation

| Mode | Tester | Typical display | Description |
|------|---------|---|---|
| VAR | Stopped | <div style="border: 1px solid black; padding: 5px; width: fit-content;"> Mode: VAR Pump: OFF <hr/> Speed Cycle/Min: 40 Preset Cycle: 100 Total Count: 200 </div> | <ul style="list-style-type: none"> Mode = VAR (variable speed) Pump = On or Off Bar graph = analogue representation of speed Speed Cycle/Min = Carriage speed (value set by user by rotating speed adjuster knob) Preset Cycle = Number of cycles in test (value set by user) Total Count = number of cycles completed (this value counts up) |
| | Started | <div style="border: 1px solid black; padding: 5px; width: fit-content;"> Mode: VAR Pump: OFF <hr/> Speed Cycle/Min: 40 Remaining: 96 Total Count: 204 </div> | <ul style="list-style-type: none"> Remaining = number of cycles left until test is complete (this value counts down) |
| ISO | Stopped | <div style="border: 1px solid black; padding: 5px; width: fit-content;"> Mode: ISO Pump: OFF <hr/> Speed Cycle/Min: 37 Preset Cycle: 73 Total Count: 227 </div> | <ul style="list-style-type: none"> Mode = ISO (fixed speed) Pump = On or Off Speed Cycle/Min = Carriage speed (fixed at 37 cycles per minute) Preset Cycle = Number of cycles in test (value set by user) Total Count = number of cycles completed (this value counts up) |
| | Started | <div style="border: 1px solid black; padding: 5px; width: fit-content;"> Mode: ISO Pump: OFF <hr/> Speed Cycle/Min: 37 Remaining: 69 Total Count: 231 </div> | <ul style="list-style-type: none"> Remaining = number of cycles left until test is complete (this value counts down) |

4.2 Display - error



Under certain conditions the following error message may be displayed:









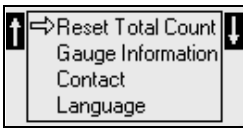

The two conditions when this error is likely to occur are:

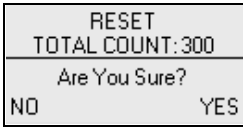
- When the tester is operating in VAR mode (variable speed), if a significant adjustment to the speed has been made in a short time period (by rotating the speed adjuster knob quickly).
- When the tester is operating in ISO mode (fixed speed), if the carriage speed differs by more than 1 cycle per minute from 37 cycles per minute for a significant period (in this event the tester would be out of specification).

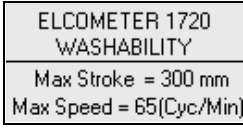
| |
|--|
| ERROR: |
| Speed Changed By More Than 5% Or 1 Cycle/Min |

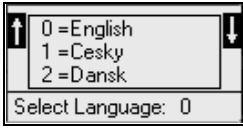
4.3 Display - menus

The menu gives access to information about your tester, language setup and reset of the counter. To view the menu, while the tester is stopped, press  (the menu can only be accessed when the tester is stopped - pressing  has no effect when the tester is started). When viewing the menus the Start and Stop buttons do not function.

| Menu | Typical display | Description |
|---|---|--|
| Press  |  | <ul style="list-style-type: none"> Use the scroll up and scroll down buttons to navigate to the menu item required and then press  to display. The selected menu will be displayed. Press  at any time to escape from a menu. |
| Reset Total Count |  | <ul style="list-style-type: none"> Resets the total counter to zero. Press Yes () to reset, or No () to leave unchanged. |
| Gauge Information |  | <ul style="list-style-type: none"> Elcometer 1720 model (<i>Abrasion, Washability</i>) Max Stroke = maximum movement of carriage (<i>Abrasion and Washability = 300 mm</i>) Max Speed = maximum speed of carriage (<i>Abrasion and Washability = 65 Cycles/Min</i>) |
| Contact |  | <ul style="list-style-type: none"> Use the scroll up and scroll down buttons to navigate to the Elcometer contact details required (UK, USA, Asia, Belgium, Canada, France and Germany). |
| Language |  | <ul style="list-style-type: none"> The current selected language is shown at the bottom of the display. Use the scroll up and down buttons to navigate to the language required. Press  - the cursor will start to flash. Use the numeric keypad to select required language (0, 1, 2, etc.) Press  - the cursor will stop flashing. All displays will then be shown in the selected language. To exit, press  (when the cursor is not flashing) |

5 TESTING A SPECIMEN

1. Switch on tester

- Connect tester to mains supply.
- Press switch at side to switch on tester.

2. Load specimen

- Raise carriage (Figure 5).
- Release holding frame clamps.
- Remove specimen holding frame.
- Position specimen.
- Replace specimen holding frame.
- Tighten holding frame clamps.
- Lower carriage.

Note: Holding frame clamps can be adjusted to suit samples of varying thickness.



Figure 5. Carriage raised and holding frame clamp released

3. Connect liquid pumping and drainage system

(For wet testing on Elcometer 1720 Abrasion and Washability Tester)

- Connect one end of liquid delivery pipe to blue connector at side of tester and push other end of pipe to the bottom of the liquid dosing bottle (Figure 6).
- Referring to Figure 6, connect end of one liquid drain pipe to connector (a) on sample tray, and end of other liquid drain pipe to connector (b) on side of tester. Place other ends of both pipes into a container suitable for liquid waste.

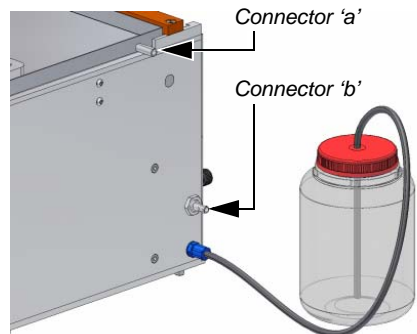

Figure 6. Liquid dosing bottle (connected to tester) and drain connectors 'a' and 'b'

4. **Purge air from liquid delivery pipes**

(For wet testing on Elcometer 1720 Abrasion and Washability Tester)

Note: To facilitate adjustment of the flow control valves, purging the liquid delivery pipes should always be performed with the carriage stationary.

- Close all flow control valves (Figure 7) using the screwdriver supplied with your tester (see “Access panel” on page 5).
- Press pump on/off button to switch on pump.
- Purge air from longest liquid delivery pipe first (valve nearest front of tester):
 - Open flow control valve. Liquid will drip onto specimen.
 - Wait until there are no more air bubbles in liquid delivery pipe.
 - Close this flow control valve.
- Working from front to back, repeat previous step on each flow control valve until air has been purged out of all liquid delivery pipes.

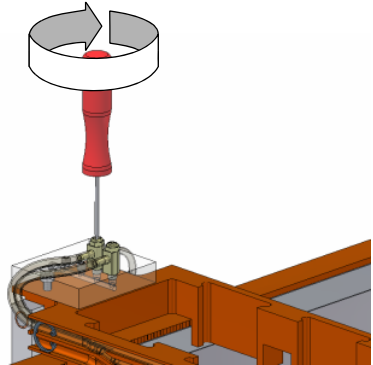

Figure 7. Adjusting a flow control valve

5. **Adjust liquid flow rate**

(For wet testing on Elcometer 1720 Abrasion and Washability Tester)

- Working from back to front, open and adjust all flow control valves until required drip rate is achieved.

6. **Fit tool**

- Place tool (or tools) into carriage (Figure 8).

7. **Configure tester**

- See “Configuring your tester” on page 7.

8. **Start test**

- Press Start button to start carriage.
- The carriage will stop automatically when the preset number of cycles is complete. If the pump was switched on, it will stop automatically also.

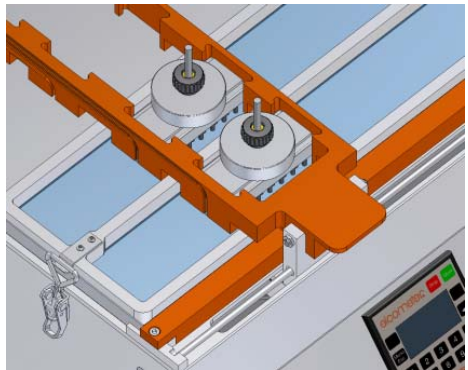

Figure 8. Tool placed into carriage

Note: After operation with the pump on, **and before raising the carriage**, close all the flow control valves. This prevents air entering the pipes when the carriage is raised. When the carriage is lowered, open the flow control valves again and adjust to the previous setting. If the carriage is left up for a period of time it will be necessary to re-purge the pipes.

Note: Do not use any type of liquid which will damage the pipework of the tester.

6 TOOLS

6.1 For Elcometer 1720 Abrasion and Elcometer 1720 Abrasion & Washability Testers

| Description | Can be used with : | Part Number |
|---|---|--------------|
| <p>Tool 1. Wild Boar Brush Wild Boar hair brush and stainless steel brush holder Total Weight : 250g (8.82oz)</p> | DIN 53378-2:83 | KT001720P003 |
| <p>Tool 2. Nylon Brush Nylon bristle brush with stainless steel brush holder and 177g (6.2oz) mass Total Weight : 454 g (16.01oz)</p> | ASTM D2486 | KT001720P030 |
| <p>Tool 3. Sponge Sponge with stainless steel holder and 337g (11.9oz) mass Total Weight : 508g (17.92oz)</p> | ASTM D4213:92, ASTM D4828 | KT001720P005 |
| <p>Tool 4. Sponge Sponge with stainless steel holder, 250g (8.8oz) and 337g (11.9oz) mass Total Weight : 750g (26.45oz)</p> | ASTM D3450 | KT001720P073 |
| <p>Tool 5. Sponge/Abrasive Sponge with two integrated abrasive pads (top and bottom, stainless steel holder and 76g (2.7oz) mass Total Weight : 232g (8.12oz)</p> | ASTM D4213 (from 1996) | KT001720P029 |
| <p>Tool 6. Abrasive Abrasive pads (x5) with aluminium holder Total Weight : 135g (4.76oz)</p> | ISO 11998 | KT001720P036 |
| <p>Tool 7. Universal Material Clamp Stainless steel holder which allows the user to fix their own test sample or abrasive material. Ideal for abrasion and wear of labels, textiles, ink, etc.</p> | | KT001720P207 |
| <p>Tool 8. Linear Abrader 'Crockmeter' Originally designed for testing colour fastness of fabrics, this tool is ideal for testing abrasion on both curved and flat surfaces and is supplied with a removable stainless steel cylindrical rod (200g/7oz), test felt, textile fixing ring and a set of additional masses - 2 x 100g (3.5oz) 200g (7oz) and 500g (17.6oz) Total Weight (excluding masses): 200g (7.05oz)</p> | ASTM F1319, ISO 105-X12, PSA D45 1010 | KT001720P074 |

| Description | Can be used with : | Part Number |
|---|--------------------|----------------|
| <p>Tool 9. Linear Abrader For testing the resistance to abrasion of automotive components, includes a felt disc of 10mm (0.4") diameter and 10mm (0.4") thick working under a mass of 400g (14.1oz) Total Weight : 400g (14.1oz)</p> | GME 60269 | KT001720P075 |
| <p>Tool 9A. Linear Abrader As Tool 9 but with a 16mm (0.63") diameter felt wool disc working under a mass of 820g (28.9oz) Total Weight : 820g (28.9oz)</p> | ECCA T11 | KT001720P075-1 |
| <p>Tool 9B. Linear Abrader Felt holder for 16mm (0.63") diameter felt wool disc working under a mass of 900g (31.7oz) Total Weight : 900g (31.7oz)</p> | EN 13523-11 | KT001720P075-2 |
| <p>Tool 10. Curved Sample Tool Height adjustable with an elbow joint for curved samples, this tool is ideal for testing abrasion resistance of both coatings and inks. Supplied with felt disc, rod for masses, 50g (1.75oz) 100g (3.5oz), 2 x 200g (7oz) and 2 x 500g (17.5oz) mass</p> | EN 60730-1-A | KT001720N003 |

7 ADJUSTING STROKE LENGTH OF THE CARRIAGE

On dispatch from the Elcometer factory your tester is set to the maximum stroke length (Abrasion Tester and Washability tester = 300 mm)

To adjust the stroke length you will need the T-bar tool and the hexagonal wrench supplied with your tester (see "Access panel" on page 5).

1. Switch off the tester and disconnect from the mains power supply.
2. Remove the specimen holding frames.
3. Remove the sample tray and rubber mat.
4. Push the carriage to the left as far as it will go.
5. Put the T-Bar tool through Hole A (Figure 9), this will lock the carriage in position.
6. Use the hexagonal wrench to loosen the two carriage securing bolts, via Hole B.
7. Push the carriage to the desired stroke length using the scale plate and pointer as a guide (Figure 10).
8. Re tighten the securing bolts via Hole B.
9. Remove the T-bar from Hole A.
10. Refit rubber matting, sample tray and specimen holding frames.

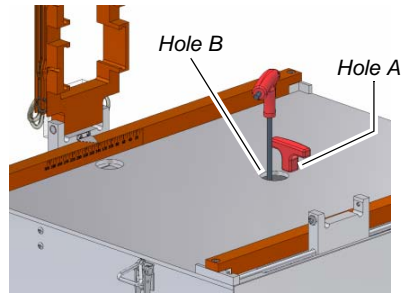

Figure 9. Insert T-bar into hole A, then use Hexagonal wrench to loosen bolts in hole B

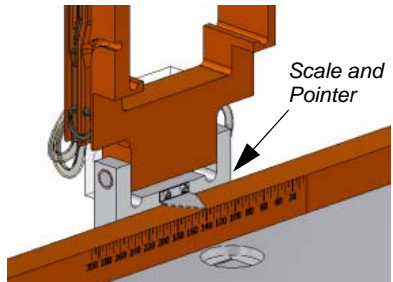

Figure 10. Adjust stroke length using scale and pointer as a guide

8 SPECIAL TESTS

Your Elcometer 1720 Tester is a versatile machine which can be used for a wide variety of tests. This section describes the operation of the machine for two special applications.

8.1 Testing Resistance of Markings

Tool 10 test the Resistance of Markings. Set up to tool as follows:

1. Adjust the stroke length of the machine to 20 mm (0.78") - see "Adjusting stroke length of the carriage" on page 15.
2. Mount the tool on the carriage of the tester (Figure 11) and tighten the two screws (a).
3. Place specimen on the table (b) and fix in place using a suitable method (mechanical, adhesive, tape, etc.).
4. Adjust height of arm (c) and tighten knob (d).
5. Place the cotton strip around the felt disc (e) and secure the ends at the top using the threaded rod (f).
6. Adjust the speed of the carriage to 60 cycles per minute (position 9 on the dial).
7. Place weights^b supplied on threaded rod to obtain required load.
8. For a wet test, immerse the cotton strip in the liquid before starting the test. The tester and tool are now ready for testing.

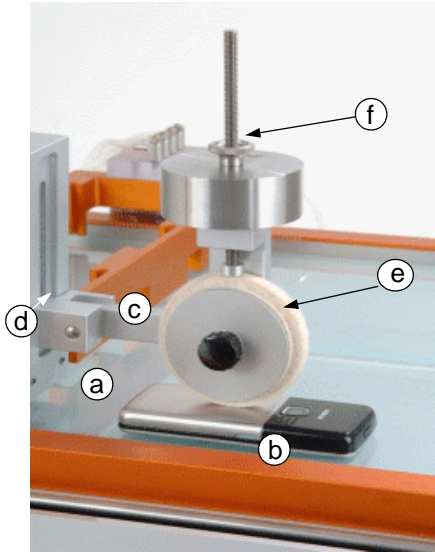

Figure 11. Tool 10

8.2 EN 607301-1

For A.1.2 add 100g (total weight = 250g)

For A.1.3 add 600g (total weight = 750g)

Perform 12 cycles.

-
- b. A set of six weights is supplied with Tool 10. These weights may be used to increase the load on the specimen up to 1700 g (60 oz) in 50 g (1.8 oz) steps. The load on the specimen with no weights added is 150 g (5.3 oz).

8.3 Testing fabrics using the 'Crockmeter'

Tool 8 (see page 14) is also known as the 'Crockmeter' and is specially designed for testing colour fastness of fabrics. Use the illustrations and notes in this section as an aid to assembly of the parts of your Crockmeter.

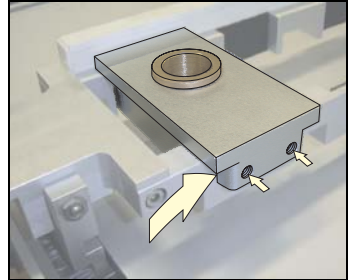
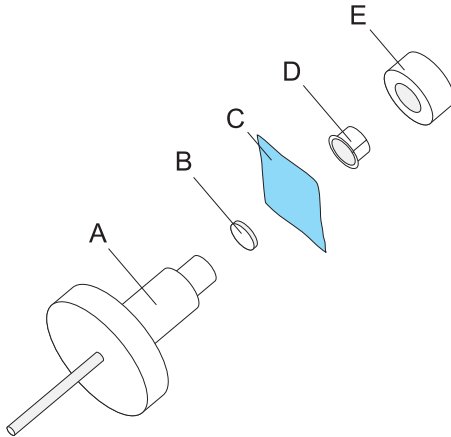

The thin metal strip (large arrow) prevents the carriage being marked by the two screws (small arrows).

To set up the tool:

| | | | |
|---|---|---|--------------------------------------|
| <p>1</p> | <p>2</p> | <p>3</p> | <p>4</p> |
| <p>Place the felt pad (B) on the end of the tool body (A) and then place the cloth (C) onto the felt pad.</p> | <p>Slide the ring (D) approximately 2 mm over the cloth and the end of the tool body.</p> | <p>Place the ring pushing tool (E) over the ring and continue to push until the cloth is held firmly by the ring.</p> | <p>Remove the ring pushing tool.</p> |

The Crockmeter tool is now ready for use.

9 MAINTENANCE

Clean and dry all tools after use. The Elcometer 1720 Tester is designed to give many years reliable service under normal operating and storage conditions.

Every six months, or sooner when used intensively, carry out the following maintenance and checks:

9.1 Lubricate the carriage mechanism

The carriage mechanism bearings should be lubricated with a lithium soap based grease such as Molykote BR2 Plus.

To lubricate the carriage mechanism bearings you will need a grease gun (not supplied) to suit DIN 71412 grease nipples and the T-bar tool and the hexagonal wrench supplied with your tester (see “Access panel” on page 5).

1. Switch off the tester and disconnect from the mains power supply.
2. Remove the specimen holding frames.
3. Remove the sample tray and rubber mat.
4. Push the carriage to the left as far as it will go.
5. Put the T-Bar tool through Hole A (Figure 12), this will lock the carriage in position.
6. Use the hexagonal wrench to loosen the two carriage securing bolts, via Hole B.
7. Push the carriage to 140 mm stroke length position using the scale plate and pointer as a guide (Figure 13).
8. Re tighten the securing bolts, leave the T-Bar tool in place.
9. The grease points are visible through holes marked on Figure 14.
10. Use a grease gun with a flexible hose to lubricate the two guide rod bearings.
11. Remove the T-bar.

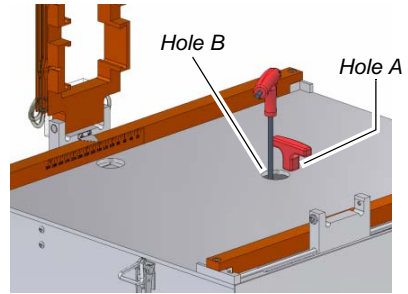

Figure 12. Insert T-bar into hole A, then use Hexagonal wrench to loosen bolts in hole B

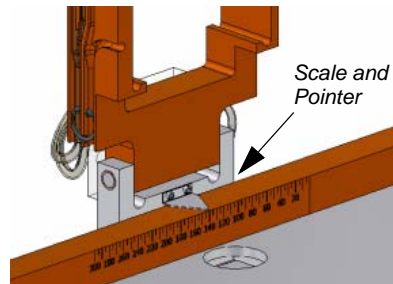

Figure 13. Adjust stroke length to 140 mm using scale and pointer as a guide

12. Refit rubber matting, sample tray and specimen holding frames.

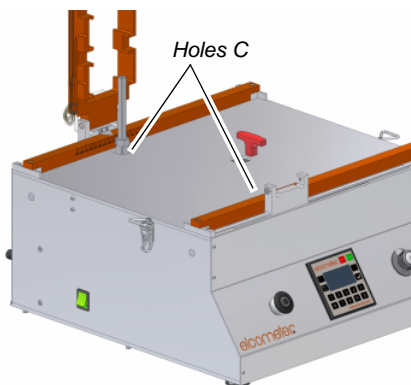

Figure 14. Grease the carriage mechanism through holes C

9.2 Check the pumping system

(This section is not applicable to the Elcometer 1720 Abrasion Tester)

- Check to ensure there is no leakage from the pump, pipework and fittings.
- Check the operation of the flow control valves.

Replacing the pump pipe

1. Switch off the tester and disconnect from the mains power supply.
2. Remove the access panel located at the rear of the tester.
3. Remove the transparent plastic cover from the pump.
4. Detach the two ends of the pump pipe.
5. Rotate the pump rotor anticlockwise. The pipe will come away from the pump.
6. Push the new pipe into the pump and rotate the pump rotor until both ends can be attached.
7. Replace the transparent plastic cover and the access panel.

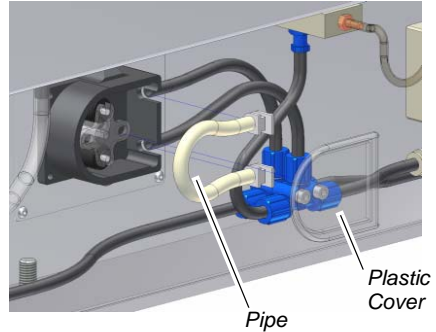

Figure 15. Remove transparent plastic cover to gain access to pipe inside peristaltic pump

9.3 Check conformity to standards

- Check the speed of the carriage.
Use a stopwatch to verify the speed at 10 cycles per minute and the speed at 65 cycles per minute. Also verify that the ASTM/ISO speed is equal to 37 cycles per minute.
- Weigh the Abrasive Pads.
Use a balance to verify that the weight of the abrasive pads and their support matches the values given in the corresponding standard.

9.4 Reconditioning nylon brushes (Tool 2, ASTM 2486)

When the bristles of the nylon brush become worn, the brush can be reconditioned as follows:

1. Place a sheet of abrasive paper (KT001720P051 - See Spares/Accessories on page 22) on the glass plate of the tester and clamp in place using the specimen holding frame.
2. Switch off the pump.
3. Select 1000 cycles on the counter.
4. Place the brush in the carriage without its holder.
5. Start the machine.
6. When the 1000 cycles are complete, remove the brush and vacuum the abrasive paper.
7. Replace the brush and perform another 1000 or 2000 additional cycles, vacuuming the abrasive paper between each 1000 cycles.
8. Finally, place the brush holder onto the brush and perform 1000 additional cycles.

Reconditioning of the brush is now complete. *Nylon brushes must be replaced when bristle length is less than 15 mm.*

9.5 Faults

The tester does not contain any internal user-serviceable components. In the unlikely event of a fault, the Elcometer 1720 should be returned to your local Elcometer supplier or directly to Elcometer. The warranty will be invalidated if the instrument has been opened.

Details of Elcometer offices around the world are given on the outside cover of these Operating Instructions. Alternatively visit the Elcometer website, www.elcometer.com

10 TECHNICAL SPECIFICATION

| | |
|--|---|
| Stroke length, Abrasion Tester: | 10 mm to 300 mm (0.4" to 11.8") |
| Abrasion & Wash Tester: | 10 mm to 300 mm (0.4" to 11.8") |
| Maximum number of cycles: | 32760 |
| Carriage speed: | 10 cyc./min. to 65 cyc./min. (Abrasion Tester) 10 cyc./min. to 65 cyc./min. (Abrasion & Wash Tester) |
| Operating voltage: | UK, 230 V AC; 0.3 A; 50 Hz EUR, 230 V AC; 0.3 A; 50 Hz US, 120 V AC; 0.6 A; 60 Hz |
| Power consumption: | 70 W |
| Number of phases: | 1 |
| Fuse rating - machine: | 1 x T2AH250V |
| Dimensions: | 550 mm x 460 mm x 320 mm (21.7" x 18.1" x 12.6") |
| Weight: (including 1 sample tray, 2 specimen holding frames and 2 glass panels) | 33 kg (73 lb) |
| Operating temperature (ambient air): | +5°C to +40°C (41°F to 104°F) |
| Transportation and storage temperature: | -10°C to +55°C (14°F to 131°F) |
| Humidity range: | Not to exceed 50% at 40°C (104°F) |
| Altitude: | Up to 1000 m (3280 ft) |
| Enclosure IP rating: | IP20 |
| Electrical enclosure: | IP42 |

According to CISPR 11 this equipment is classed as group 1, class A.

Group 1 equipment is equipment in which there is intentionally generated and/or used conductively coupled radio-frequency energy, which is necessary for the internal functioning of the equipment itself.

Class A equipment is equipment suitable for use in all establishments other than domestic and those directly connected to a low voltage power supply network which supplies buildings used for domestic purposes.

11 SPARE PARTS AND ACCESSORIES

The following replacement items and optional accessories are available from your local supplier or direct from Elcometer:

| Part Number | Description |
|-----------------------|--|
| KT001720P003 | T1: Wild Boar Brush : DIN 53778 |
| KT001720P004 | Wild Boar Brush for Tool 1 |
| KT001720P051 | Abrasive G120 Sheet (4) for Tools 1 & 2 |
| KT001720P030 | T2: Nylon Brush (177g): ASTM D2486 |
| KT001720P009 | Nylon Brush for Tool 2 |
| KT001720P051 | Abrasive G120 Sheet (4) For Tools 1 & 2 |
| KT001720P005 | T3: Sponge (337g): ASTM D4213 & D4828 |
| KT001720P073 | T4: Sponge (337g & 250g): ASTM D3450 |
| KT001720P006 | Sponge (5) for Tools 3 & 4 |
| KT001720P029 | T5: Sponge/Abrasive (76g): ASTM D4213 |
| KT001720P141 | Sponge/Abrasive (5) for Tool 5 |
| KT001720P036 | T6: Abrasive (5 Pads): ISO 11998 |
| KT001720P037 | Abrasive Pads (10) for Tool 6 |
| KT001720P064 | Abrasive Pads (100) for Tool 6 |
| KT001720P207 | T7: Universal Material Clamp |
| KT001720P208 | 25m Abrasive Roll for Tool 7 |
| KT001720P074 | T8: Linear Abrader: ASTM/ISO/Renault |
| KT001720P075 | T9: Linear Abrader Tool (400g): GME 60269 |
| KT001720P075-1 | T9A: Linear Abrader Tool (820g): ECCA T11 |
| KT001720P075-2 | T9B: Linear Abrader Tool (900g) |
| KT001720N003 | T10: Curved Sample Tool (Felt): EN 60730 |
| KT001720P062 | Felt Discs (2) for Tool 10 |

MISCELLANEOUS ACCESSORIES & SPARES

| Part Number | Description |
|--------------------|---|
| K0004695M068 | Leneta Plastic Scrub Test Panel, Black (100 pcs) |
| K0004695M069 | Leneta Plastic Scrub Test Panel, White (100 pcs) |
| KT001720N002 | Abrasive Scrub Media - SC2 |
| KT001720P012 | Metal Strip, 250um (10 mils): ASTM |
| KT001720P013 | 10m Replacement Channel Gasket |
| KT001720P214 | Glass Plate (478 x 165mm) |
| KT001720P019 | 500g Mass (To Fit Tools 1 - 8, 10) |
| KT001720P031 | 227g Mass (To Fit Tools 1 - 8, 10) |
| KT001720P018 | 200g Mass (To Fit Tools 1 - 8, 10) |
| KT001720P017 | 100g Mass (To Fit Tools 1 - 8, 10) |
| KT001720P016 | 50g Mass (To Fit Tools 1 - 8, 10) |
| KT001720P042 | Channel Clamp (1 off) |
| KT001720P038 | Peristaltic Plump Tube |
| KT001720P039 | Hexagonal Wrench |
| KT001720P040 | Replacement/Spare T-Bar |
| KT001720P041 | Replacement/Spare Screwdriver |
| KT001720P043 | Replacement/Spare Plastic Bottle and Lid |
| KT001720N011 | 2-4 Station Upgrade Kit for Abrasion Tester |
| KT001720N111 | 2-4 Station Upgrade Kit for Abrasion and Washability Tester |

12 RELATED EQUIPMENT

In addition to the Elcometer 1720 Tester, Elcometer produces a wide range of other equipment for determining the physical characteristics of surface coatings. Users of the Elcometer 1720 may also benefit from the following Elcometer products:

- Elcometer Taber 5750 Linear Abraser
- Elcometer Taber 5135 and 5155 Rotary Abrasers
- Elcometer 3508 Coating Applicator

For further information contact Elcometer, your local supplier or visit www.elcometer.com