

NEW

Variable Range Output

Versatile DC Power Supplies

TBseries

Max. output voltage : 35 V to 1000 V
Max. output current : 1 A to 108 A
Max. output power : 360 W, 720 W, 1080 W

**720W
Model**



**1080W
Model**



**360W
Model**



Available for the pulse / ramp sequence operation without using a PC

Suppressing the overshoot is possible by the standard function that can change CV mode and CC mode optionally

The programmable internal resistance function allows you to simulate rechargeable batteries

TB series

DC power supplies with wider output coverage

1080W Model



Wide range output is possible with “turbo function” installed.

720W Model



360W Model



TB series is programmable DC power supply with distinctive turbo function which realises 3 times wider coverage of output voltage and current in comparison to conventional DC power supply with equivalent output power.

All TB series allow flexible voltage and current output within its rated power, resulting user not to require to search for power supply with unnecessary wider rated voltage and current. Thus single TB unit can be used for much wider user applicaton.

Not only its flexible output, but the general performance of the power supply is pursued to achieve overwhelming quality, resulting; power factor correction circuit with 0.99 power factor, speedy and accurate 4 digit display panel as well as adoption of precision rotary encoder. TB series's high energy efficiency contributes to user's reduction of CO2 emission.

Digital communication(*1) with LAN(Ethernet*2), USB, RS-232C, RS-485 and GPIB is optionally selectable, best for automatic measuring or integration to production equipment.

(*1) A conversion adapter or additional option is required separately.

(*2) Ethernet is the registered trademark of Xerox Co., Ltd.

TB series are also available in such a use.

[For simulation of solar cells] *This is customization.

It is possible to test or inspect micro inverter because TB can do simplified simulation of I-V characteristic of the solar panel. If you want to talk with us for details, please tell our sales office “the model number of solar cell which you want to simulate” and “specifications of micro inverter for testing or inspection”.

Typical Applications

Evaluation of electric elements for automobile
Covered from 12 V to Higher Volt. by this One Unit.

Evaluation for devices

For devices with different rated values.

Evaluation with series / parallel connected power supplies

Suitable for battery, capacitor evaluation with series / parallel connected power supplies.

Evaluation of Communication Equipment

To various Tests for Servers and Router.

Evaluation of Power Conditioners

For simulation of Solar Battery and Fuel Battery.

Features



It realizes **Wide Range Output** by installed **Turbo Function**.



CV / CC preference function helps to **suppress voltage / current overshoot** at output trigger.



Simplified Simulation of rechargeable batteries, photovoltaic cell and fuel cell with **the variable internal resistance**.



Usage for High Speed Response and Usage to Keep Voltage is applicable by **Switching Function for Sink/Anti-Sink**.



Best fit to Research and Development by **the Low Noise Switching System**.



Free to Service Space with **the Power Factor Correction Circuit** and **Worldwide Input System**.

Lineup

| Model | Maximum Output | | | Ripple | | Dim. (P.8-9) |
|----------------|----------------|---------|--------|---------|---------|--------------|
| | Volt | Current | Power | (mVrms) | (mArms) | |
| TB35V36A360W | 35 V | 36 A | 360 W | 8 | 30 | A |
| TB35V72A720W | | 72 A | 720 W | 15 | 60 | C |
| TB35V108A1080W | | 108 A | 1080 W | 20 | 200 | E |
| TB80V14A360W | 80 V | 14 A | 360 W | 7 | 16 | A |
| TB80V28A720W | | 28 A | 720 W | 15 | 30 | C |
| TB80V42A1080W | | 42 A | 1080 W | 10 | 54 | E |
| TB160V8A360W | 160 V | 8 A | 360 W | 15 | 10 | A |
| TB160V15A720W | | 15 A | 720 W | 20 | 15 | C |
| TB160V22A1080W | | 22 A | 1080 W | 20 | 25 | E |
| TB250V5A360W | 250 V | 5 A | 360 W | 20 | 10 | A |
| TB250V10A720W | | 10 A | 720 W | 25 | 12 | C |
| TB250V15A1080W | | 15 A | 1080 W | 30 | 25 | E |

| Model | Maximum Output | | | Ripple | | Dim. (P.9) |
|-------------------|----------------|---------|--------|---------|---------|------------|
| | Volt | Current | Power | (mVrms) | (mArms) | |
| TB350V3A360W * | 350 V | 3 A | 360 W | 25 | 11 | B |
| TB350V6A720W * | | 6 A | 720 W | 30 | 10 | D |
| TB350V9A1080W * | | 9 A | 1080 W | 35 | 16 | F |
| TB650V1.6A360W * | 650 V | 1.6 A | 360 W | 30 | 6 | B |
| TB650V3.2A720W * | | 3.2 A | 720 W | 35 | 7 | D |
| TB650V4.8A1080W * | | 4.8 A | 1080 W | 40 | 20 | F |
| TB850V1.2A360W * | 850 V | 1.2 A | 360 W | 35 | 5 | B |
| TB850V2.4A720W * | | 2.4 A | 720 W | 40 | 10 | D |
| TB850V3.6A1080W * | | 3.6 A | 1080 W | 45 | 15 | F |
| TB1000V1A360W * | 1000 V | 1 A | 360 W | 40 | 5 | B |
| TB1000V2A720W * | | 2 A | 720 W | 45 | 10 | D |
| TB1000V3A1080W * | | 3 A | 1080 W | 50 | 15 | F |

* The front panel does not have monitor terminals.

Images of Output Range

Possible to output wide range volt. and current compared with traditional DC power supplies by the turbo function.

[35V models]

TB35V36A360W
TB35V72A720W
TB35V108A1080W

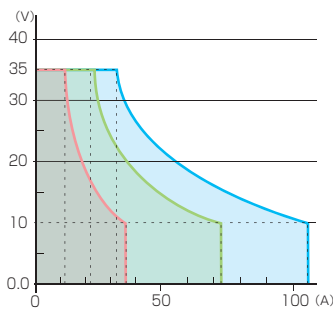

[250V models]

TB250V5A360W
TB250V10A720W
TB250V15A1080W

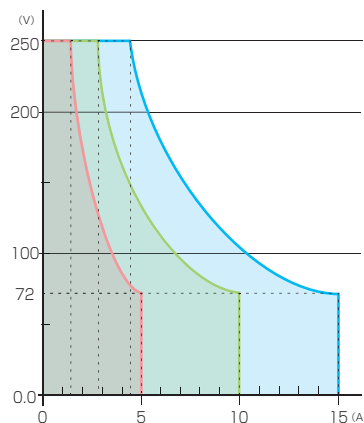

[1000V models]

TB1000V1A360W
TB1000V2A720W
TB1000V3A1080W

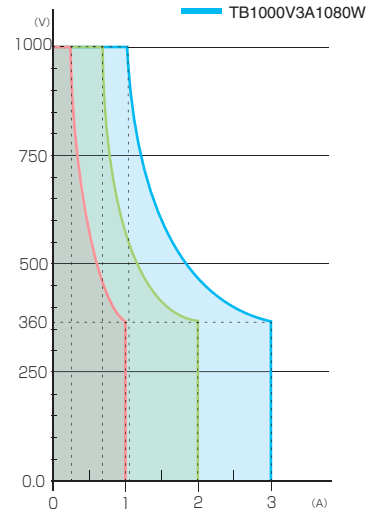

Principal Functions

Function for Pulse & Ramp Sequence and Master Follow

Output control as next A to D are possible.

A. Pulse Sequence

Sequential operation is possible by using voltage and current set on each memory a, b and c in combination with multi-set function. Not only continuous operation, but also it is possible to specify the times. It is best fit to evaluation tests for products as various operations, like as repeat of a and b only or repeat of b, c and off only, are enabled by setting time of memory a, b, c and off to 0.0.

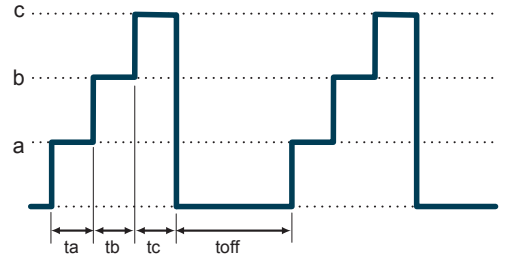

ta, tb, tc and toff can be set to 0.0 s, 1.0 s to 99.9 h, respectively

B. Ramp

It enables to make ramp action up to set voltage or current (or from the set voltage or current to 0 V or 0 A). It is useful to like to rise (reduce) voltage or current slowly. It helps sensitive electrical load not to get damaged by overshoot.

* For ramp action, it is possible to select “both of set voltage and current”, “only set voltage” or “only set current”.

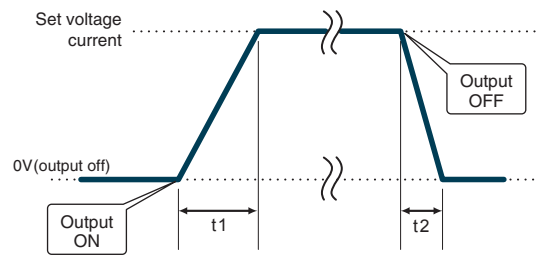

t1 and t2 can be set to 0.0 s, 0.1 s to 999 s, respectively

C. Pulse Sequence + Ramp

It is also possible to use pulse sequence combined with ramp action. If multi-set function is combined with the too, it is able to make sequence action by using voltage or current set on memory a, b and c. Not only continuous operation, but also it is possible to specify the times. It is useful in various aspects as it is possible to rise (reduce) voltage or current slowly up to 3 set value.

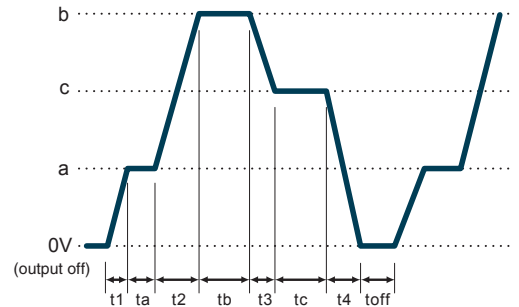

Range of 0.0 s, 0.1 s to 999 s for t1 to t4 and range of 0.0 s, 1.0 s to 99.9 h for ta to tc and toff can be set respectively.

D. Master Follow

Pulse sequence actions at master-slave and output signal to slave units at ramp action are transmitted. By this function, it is possible to make slave units to output on different output condition from the master unit.

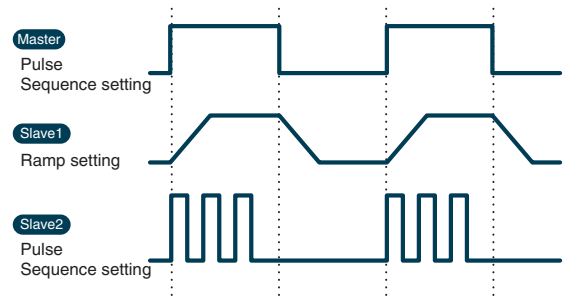

[Important point]

- ① This function can not be used with Delayed trigger function (refer to page. 5) and -LFs option (refer to page. 10) together.
- ② Accuracy of the timer at sequence action $\pm 0.5\%$. Please take care usage at long running.

CC / CV Preferred setting

CV(constant voltage) or CC (constant current) preferred mode can be selectable. When a load is such as a diode whose resistance value can dramatically change at certain point, overshoot of current may take place if power supply is triggered on under CV mode. TB series can help suppress this overshoot by choosing CC mode trigger as preference. This feature is highly valued for lowering the risk of damaging expensive load typically such as high power laser diode module.

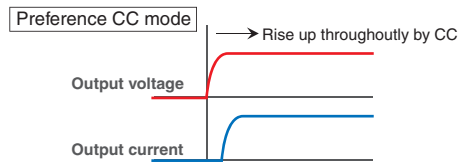
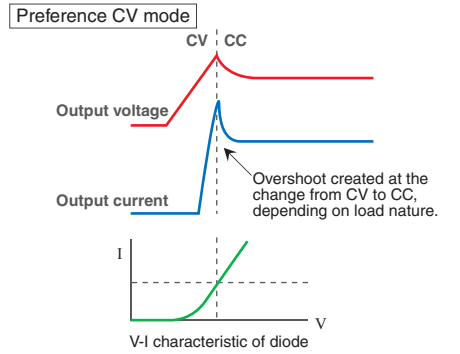

* More help not to create overshoot even at preference CC mode is to set the voltage as low as possible to such value that still allows CC mode operation, but not to set it maximum.

Internal resistance value variable function (CV mode only)

By setting the internal resistance value as any value, it causes voltage drop due to load current. This is best fit for simulating battery, solar cell panel, fuel cell battery. (Programmable range of the internal resistance value is 0 Ω to rated voltage / rated current)

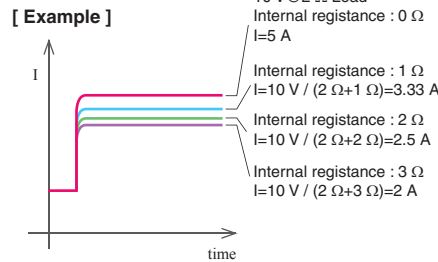

Function for Multi-setting

3 values for voltage and current are memorized in addition to usual ones of preset. It is very useful for experiment to collect repeatedly data and inspection of products.

2 Modes for Lock

Either of 2 Modes can be selected and set, "Full Lock" that locks all operation from the front panel or "Normal Lock" that locks only output ON / OFF. (the above 2 modes can stop the output emergently with the power switch.)

Switching function of Sink / Anti-Sink

Sink Function is built in power supplies. It is safe because it can lower voltage quickly even when it is at cut-off output and high voltage setting point. And, when make continuously burn-in with short interval, it is possible to disconnect and change work quickly after cut-off operation of output. Conversely, when supply power to battery, condenser and so on which is capacious load, it decrease reverse current from the load to power supplies and avoids voltage depression by using Anti-Sink Function at cut-off output or when lower setting voltage.

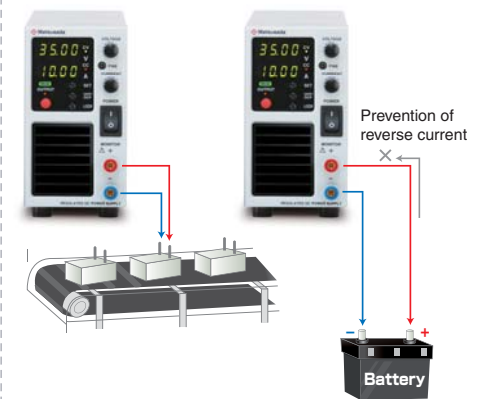

Note : It is impossible to stabilize by reverse current control. If the load is what reverse voltage becomes higher than rated voltage (induced load, regenerative motor, etc.), please protect the power supply by connecting dummy resistor, reverse current protection diode and so on.

Delayed Trigger Function

The delayed trigger function allows it to delay the time for output start and output stop and work based on it during OUTPUT ON / OFF. The delayed trigger function can be used when 1 unit of TB is used, of course. The delayed trigger function can also be used when output voltage / output current are set individually by connecting several Matsusada power supplies using master-slave connection terminal.

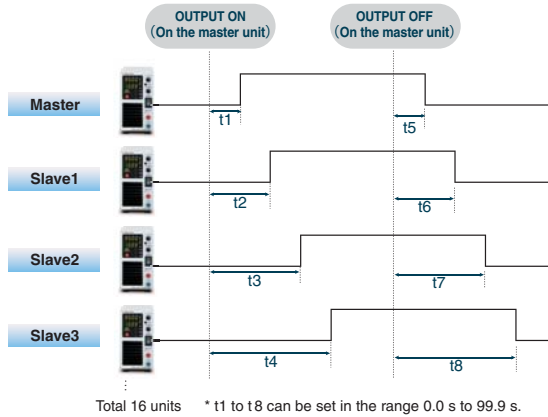

- *1 : This function can not be used with Function for Pulse & Ramp sequence and Master Follow (refer to page. 4) and -LFs option (refer to page. 10) together.
- *2 : Can be connected up to 16 units.
- *3 : R4K-36 series, R4K-80 series, RK-80 series, RK series and REK series. Detail catalog for each model is available. Please contact nearby sales office.
- *4 : Only for slave-local. In case of slave remote control, exact same model of power supply need to be used. Also, in case of slave-local, each output voltage and current can be set individually. In case of slave-remote, output voltage and current can be set with one-control function which each slave unit follows the master unit setting.

Dual Tracking and Multi-Output

By connecting power supplies to make the output of it become positive and negative at master-slave, the output of positive and negative can be controlled at the save time. (Dual tracking control) Multi-output can be configured in combination with actions of local mode and of dual tracking. Plus and minus output voltage and optional output voltage set on a local slave are outputted in synchronizing with ON of the master unit.

* As for connection, please refer to "examples for operation applied" on Page 11.

Dual Tracking

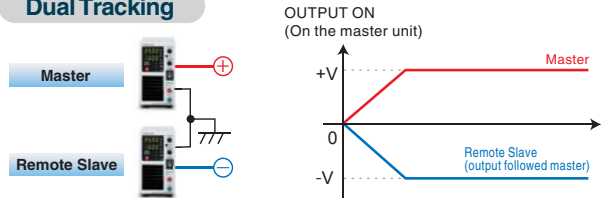

Multi Output

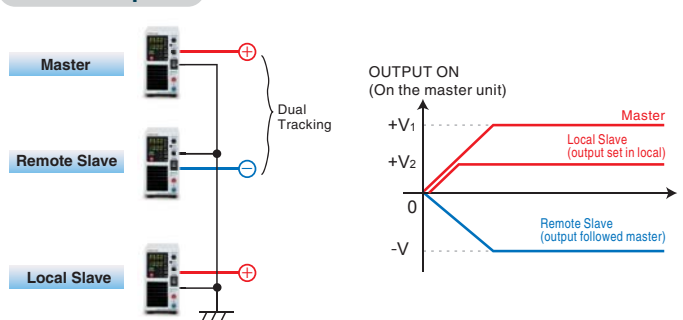

Principal Functions

Remote Switch ON / OFF

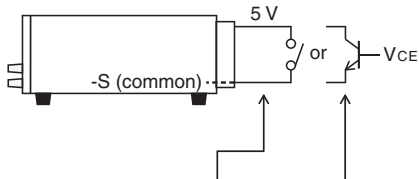

| Output | Relay | Open Collector |
|--------|-------|-----------------------------|
| ON | Short | $V_{CE} \leq 0.4 \text{ V}$ |
| OFF | Open | $V_{CE} \geq 2 \text{ V}$ |

- Sink current 1 mA
- Logic of OUTPUT can be made reverse.

Master-slave Control (Digital interface)

Master unit can control multiple units connected as slave. Please refer to P.4 "D. Master Follow", P.5 "Delayed Trigger Function" and "Dual Tracking and Multi-Output".

* This is not a function for parallelly connected power supplies to give out average output current.

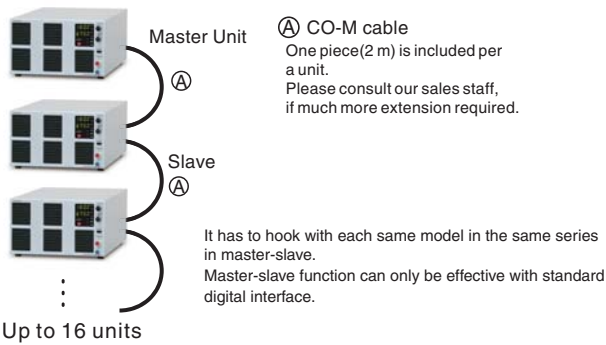

Ⓐ CO-M cable
One piece (2 m) is included per a unit.
Please consult our sales staff, if much more extension required.

It has to hook with each same model in the same series in master-slave.
Master-slave function can only be effective with standard digital interface.

Digital Interface

In addition to digital control with LAN (Ethernet), USB, RS-232C, RS-485 and GPIB, one control is enabled in master-slave operation.

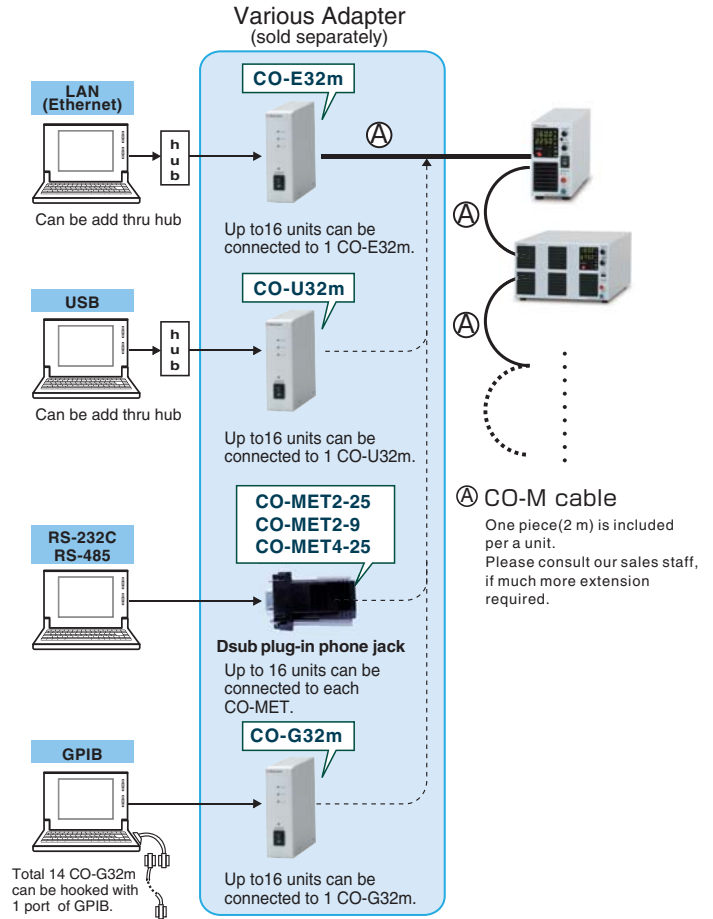

When noisy environment is presumed, -LGob (optical interface) is required.
See page 10 for detail.

Remote Control

● Switching REMOTE / LOCAL



| Mode | External Relay | TTL |
|--------|----------------|------|
| REMOTE | short | LOW |
| LOCAL | open | HIGH |

Each mode for Voltage, Current, OVP, OCP can be switched with relay or TTL signal.

● Output Control

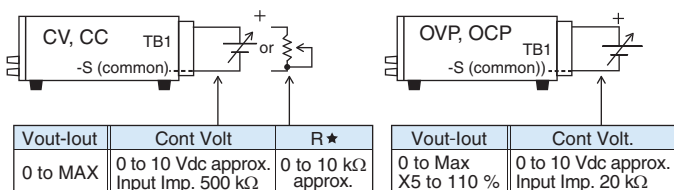

* Possible to switch 10 kΩ to 0 kΩ for Fail-Safe

● Output Monitor

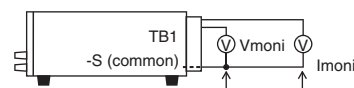

| Output | Vmoni | Imoni |
|----------|---|---|
| 0 to MAX | 0 to 10 Vdc approx. Output imp. 1 kΩ | 0 to 10 Vdc approx. Output imp. 1 kΩ |

● Output of Status

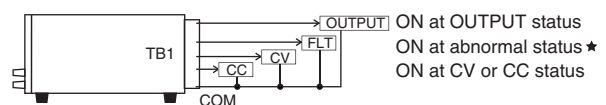

* ON for the status of OVP, OCP, OTP, ACF reverse sense connection and interlock (LD).

COMMON is floating with the output of Open Collector for each COMMON.
Voltage Resistance 30 Vdc, Sink Current $\leq 5 \text{ mA}$

Specifications

| | |
|-----------------------------|--|
| Input Voltage | 100 to 240 VAC, 50 / 60 Hz Single Phase Power Factor at 100 VAC input and max. output : 0.99 typ. |
| Input Current | 5.2 Amax(360W Model), 11 Amax(720W Model), 16 Amax(1080W Model) at 100 VAC input |
| Output Control | Local : Constant Voltage Rotary Encoder on the Front Panel (if output power is set beyond max. output volt., output current is lowered automatically.) Constant Current Rotary Encoder on the front Panel (if output power is set beyond max. output current, output volt. is lowered automatically.) (Max. power : 420.2 W for 400W Model, 840.5 W for 800W Model, 1680 W for 1600W Model) Remote : Constant Voltage External Control Voltage 0 Vdc to 10 Vdc or External Variable Resistor 0 Ω to approx. 10 kΩ Constant Current External Control Voltage 0 Vdc to 10 Vdc or External Variable Resistor 0 Ω to approx. 10 kΩ |
| Voltage Regulation | For Input : 0.05 % of maximum output (to±10 % of AC change) For Load : 0.1 % of maximum output (to 10 % to 100 % of load change) |
| Current Regulation | For Input : 0.05 % of maximum output (to±10 % of AC change) For Load : 0.1 %* of maximum output (to 10 % to 100 % of load change) |
| Stability | 0.05 % / 8H of maximum output voltage |
| Temp. Coefficient | 0.01 % / °C of maximum output voltage 0.04 % / °C of maximum output current |
| Output Display | Output Voltage : 4 digits for digital indicator (±0.5 %rdg±5 digit, at 23 °C±5 °C) Output Current : 4 digits for digital indicator (±0.5 %rdg±5 digit, at 23 °C±5 °C) |
| Monitor Output | Output Voltage Monitor : 10 V / max. output voltage Output Current Monitor : 10 V / max. output current |
| Protection | <ul style="list-style-type: none"> ● Overvoltage Protection (OVP) : Cut off the output at the set pointS ● Overcurrent Protection (OCP) : Cut off the output at the set point Range of set : approx. 5 % to 110 % of Rating Setting Method : Rotary Encoder on the front Panel or External Control Voltage 0 Vdc to 10 Vdc ● Over Power Protection (OPP) : Cut off the output at the set point 396 W for 360W Model, 792W for 720W Model, 1188 W for 1080W Model Reset : Manual return with OUTPUT switch or remote switch ● Over Temp. Protection (OTP) : Cut off the output at abnormal internal heating Reset : Manual return with OUTPUT switch or remote switch(after lowered to normal temp.) ● Input Voltage Drop , Blackout Protection : Cut off the output at input voltage drop Reset (after returned to normal voltage or from blackout) at Power Fail. Protec. (=Re-output Prevent.)...Manual return with OUTPUT switch or remote switch at Power Fail. Protec. (=Re-output Prevent.) canceled...Automatic return ● Remote Sense Connected in Reverse ● Interlock (LD) |
| Miscellaneous Functions | <ul style="list-style-type: none"> ● Prevention of Miss Operation by Locked Key (A change of normal lock and full lock is possible.) ● Digital Master-Slave Operation (16 units can be hooked in series or parallel.) ● Last set Memory ● Noise Control for Forced Cooling ● Remote Sensing ● ON / OFF with Remote Switch (TTL or External Relay) ● Signal Output for Status (CV, FLT, OUTPUT) ● Delayed Trigger Function : Separated setting for ON Delay / OFF Delay (0.0 to 99.9 sec) ● Multi Set Function : 3-memory for voltage or current can be set separately with usual voltage or current. |
| Transient Response Time | Recovery Time 1 ms (at constant voltage operation, time returned to within 10 % of set voltage for load change of 70 % to 100 %) |
| Operation Temperature | 0 °C to +50 °C |
| Storage Temperature | -20 °C to +70 °C |
| Humidity | 20 % to 80 % RH (no condensation) |
| Dielectric Strength Voltage | For 1 minute at 1000 V between the input power supply and the output terminal and between the input power supply and the chassis. |
| Grounding Withstand Volt. | ±250 V-DC (Grounding positive or negative terminals are possible) |
| Accessories | <ul style="list-style-type: none"> ● Instruction Manual (1) ● Cover for remote connector (1) ● Cover for output terminal (1) (refer to P.8 for detail.) ● CO-M cable, 2 m length (1) ● AC input cable, 3 cores for single phase type (1) |

* The current regulation (for load) of the model whose maximum output current is 0.2 %. (for the load change of 10 % to 100 %)

A lot of Digital Control Functions

| | | |
|-------------------|--|--|
| Control Functions | <ul style="list-style-type: none"> ● Output ON / OFF set ● Digital Control for 16 units(-LGob models : 32 units) ● Package Control for Multi-hooked Units ● Display of Various Status (Error Display / Status of Output / OVP / OCP / OPP / OTP / ACF / Reverse Connection of sense / Interlock) | |
| Writing Function | Setting for Output Volt. / Output Current | Percent Mode (100.00 %), * Volt. / Current mode (Max. Rated Value for Volt. / Current) |
| | Setting for OVP / OCP | Percent Mode (100.00 %), Volt. / Current mode (Max. Protection Value to Overvoltage / Overcurrent) |
| Read Function | Measuring for Output Volt. / Output Current | Percent Mode (100.00 %), * Volt. / Current mode (Max. Rated Value for Volt. / Current) |
| | Set Values of Output Volt. / Output Current | Percent Mode (100.00 %), * Volt. / Current mode (Max. Rated Value for Volt. / Current) |
| | Setting of OVP / OCP | Percent Mode (100.00 %), Volt. / Current mode (Max. Protection Value to Overvoltage / Overcurrent) |

* Minimum value for each model is the same with the minimum displayed digit the indicator on the front panel.

Description of functions (Below image is 360W model.)

Front Panel

360W model only is equipped with FINE switch(12), which enables to jump into neighboring digit at voltage / current setting.

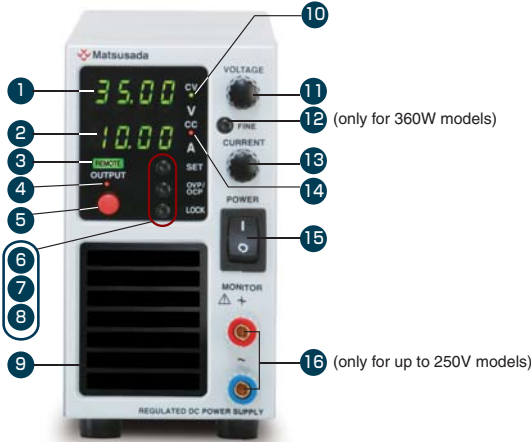

- 1 Display Output Voltage and OVP setting
- 2 Display Output Current and OCP setting
- 3 Display Remote Programming, lighted during remote control of Voltage / Current.
- 4 Display OUTPUT lighted during output.
- 5 ON / OFF Switch for Output, used for ON / OFF for output at remote and reset of Protections.
- 6 Preset Switch for Output
- 7 Setting Switch OVP / OCP
- 8 Setting Switch Key Lock
- 9 Intake hole
- 10 Display Constant Voltage Operation Mode
- 11 Setting Knob for Output Voltage(shared OVP Setting)
- 12 FINE Switch change over set digit at setting output voltage and current.
- 13 Setting Knob for Output Current(shared OCP Setting)
- 14 Display Constant Current Operation Mode
- 15 ON / OFF Power Switch it has priority over all actions for safety.
- 16 Terminals for a Monitor(up to 20 A.The size is M6)
- 17 Ventilation Hole
- 18 Digital Interface used for master-slave and delay trigger too.
- 19 Connector for remote control (TB1)
- 20 Grounding terminal

Rear Panel

[up to 250V models]

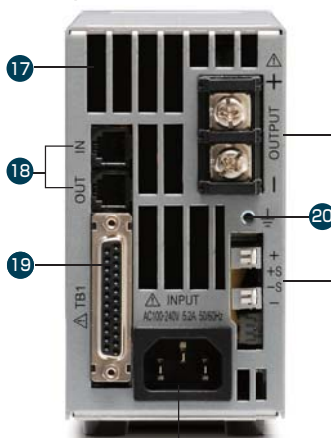

Output Terminal

- 360W Model : Terminal board
- 720W, 1080W Model : Busbar

Remote Sensing

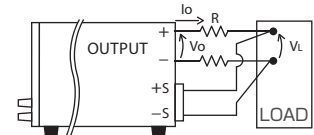

Prevent to degrade stability due to volt. drop (Vo-VL) by resistance(R) of output wiring or contact resistance. (up to max. 0.5 V)

[more than 350V models]



Output Terminal

Slueless terminal board

Specifications of cables to use

| | |
|--|--|
| Appropriate wire | Single wire : 1.2 mm in diameter (AWG16) Twisted wire : 1.25mm ² (AWG16) Diameter of strand : more than 0.18 mm |
| Usable wire | Single wire : 0.4 mm to 1.2 mm (AWG26 to 16) Twisted wire : 0.3 to 1.25 mm ² (AWG22 to 16) Diameter of strand : more than 0.18 mm |
| Standard length of the part which peeled coating | 11 mm |
| Suitable tool for pulling / connecting the wire | Flat-blade screwdriver (Axial diameter : 3 mm, the width of the edge of a blade : 2.6 mm) |

Caution about the diameter or a cross-section of wire mentioned above
When the dimensions that are prescribed by AWG do not conform to the value of cross-section, please apply the latter.

The models whose dimensions are from B to F in P.9 have the cover for output terminal.

B, D, F models ▶



C, E models ▶



Dimensions inch(mm)

A 360W Models ①

Weight : 3 kg approx.

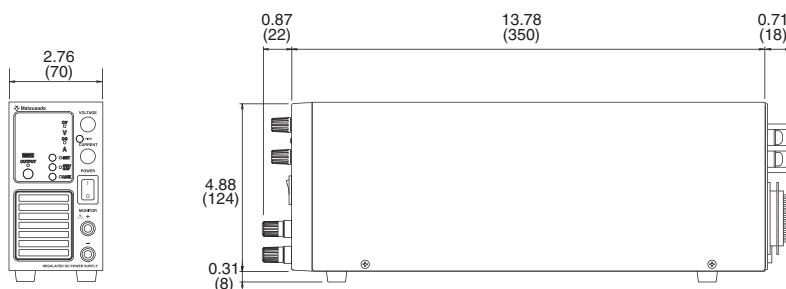

B 360W Models ②

Weight : 3 kg approx.

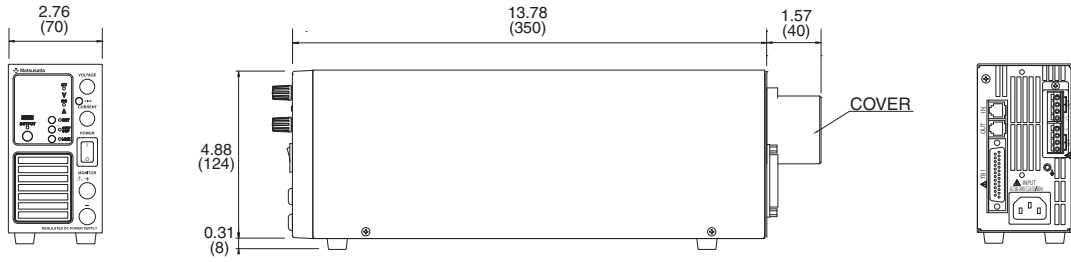

C 720W Models ①

Weight : 5 kg approx.

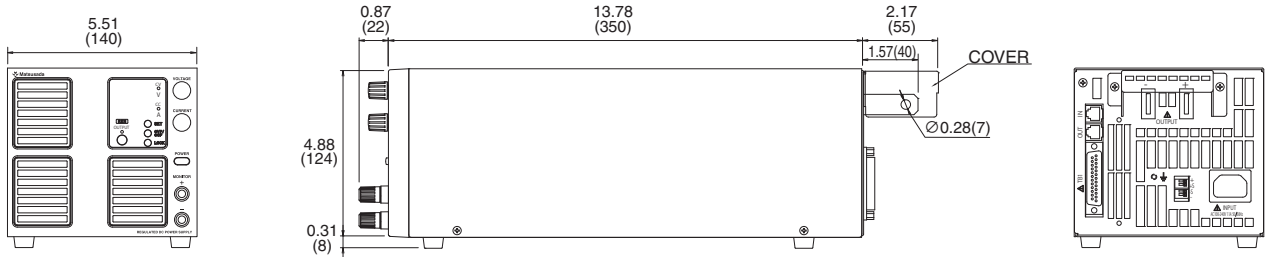

D 720W Models ②

Weight : 5 kg approx.

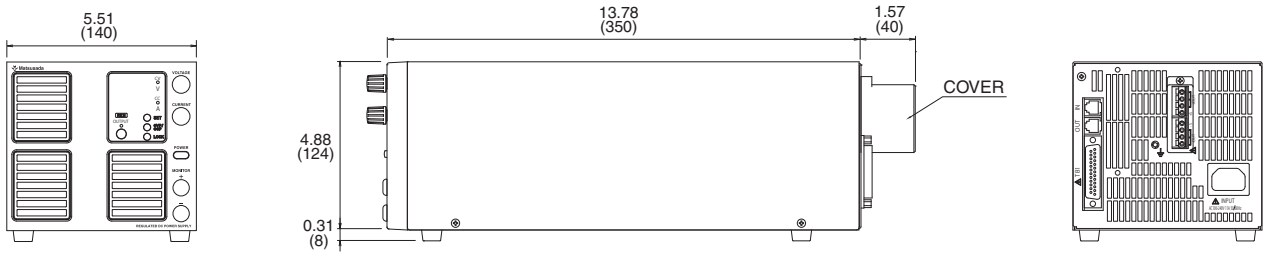

E 1080W Models ①

Weight : 8 kg approx.

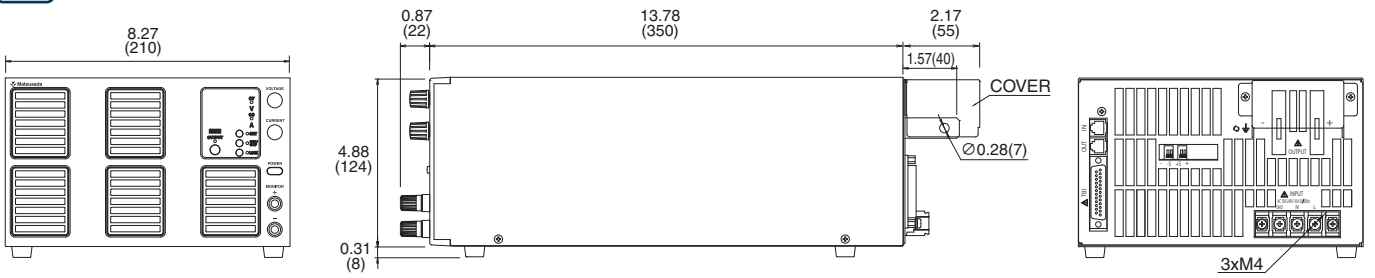

F 1080W Models ②

Weight : 8 kg approx.

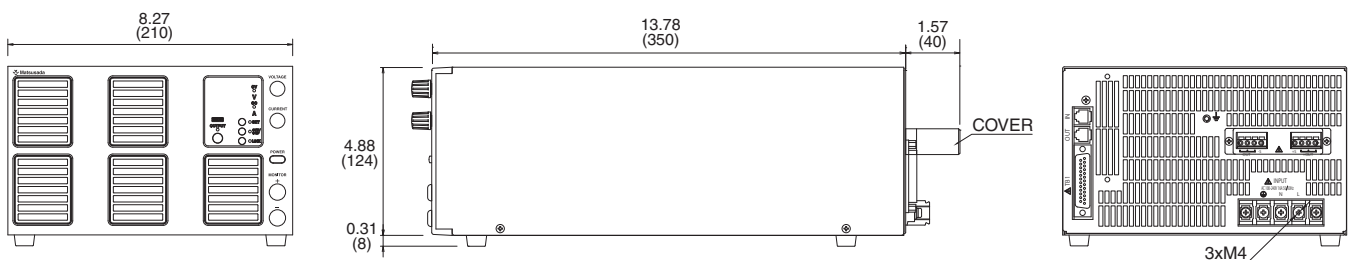

Options

-LMi : Multi-digital interface ^{*1} coming soon (only for the models whose dimensions are A in P.8)

Digital control by LAN(Ethernet), USB(USBTMC) and RS-485(Multidrop) is available. (These simultaneous use is impossible. And, RS-485 supports only FULL DUPLEX communications.) This option includes -L(SCPI)option, and attaches IVI driver corresponding to SCPI command. It makes it easy for control program development with various programming languages such as LabView, VisualBasic and C# etc.

-LGoB : Optical interface Board ^{*1}

- LGoB Optical Interface board + Optical cable 2 m
- LGoB(Fc5) Optical Interface board + Optical cable 5 m
- LGoB(Fc10) Optical Interface board + Optical cable 10 m
- LGoB(Fc20) Optical Interface board + Optical cable 20 m
- LGoB(Fc40) Optical Interface board + Optical cable 40 m

Insulation control is made with optical communication. As perfect insulation is made by optical fiber it is able to forestall miss operation as transient phenomenon caused by surge, dielectric thunder or foreign noise, etc.

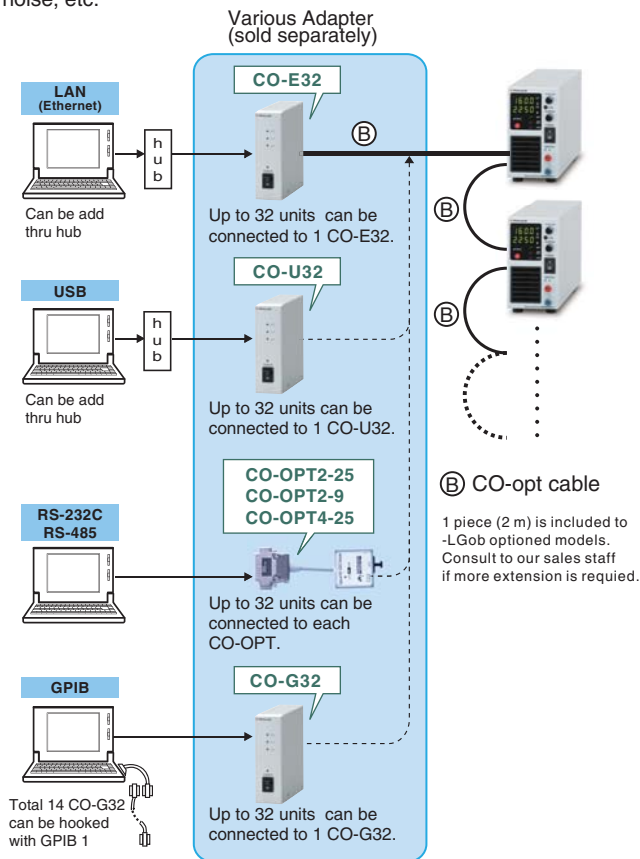

- ★ When using them under the following conditions, always select -LGoB.
 - Noisy environment as in a factory. (Ex. A motor or a coil is used near to load or power supply)
 - Used in high voltage floating. (250 V and higher)
 - Our power supply and controller (PC or PLC) can not be installed within 2 m.
- ★ If you use plural TB in optical communication, please use them according to the following ways.
 - Connecting all TB which have optical I/F board serially
 - Connecting all TB serially ; the first TB is optical I/F board type, and all TB after the 2nd are standard I/F board type.

-LFs : Pause air-cooling fan

The air cooling fan of the power supply can be stopped for 1.0 to 120.0 seconds. The time to stop can be arbitrarily set in 0.1 second increments on the front panel. (Depending on the usage conditions, the output may be turned off by the protective function of the main unit.)

-LMs : Analog Master-Slave

Up to 3 units (same model) including the master unit can be operated in parallel by using the remote connector. Users can control units using remote control or standard / optional digital interface for master unit. (One control) This function can not be used with Function for Pulse & Ramp sequence and Master Follow (refer to page. 4) and Delayed trigger function (refer to page. 5) together.

- Each parallel connected power supply outputs even current.
- The output voltage and output current of the entire system can be displayed on the master unit.
- Since models with this option are different in delivery time from standard models, please be sure to confirm the delivery date with our sales staff.

Optional items Analog Master-Slave Cable

Model : TB-MS2 Cable (to connect 2 units) TB-MS3 Cable (to connect 3 units)

It is a convenient connecting cable with connectors assembled. (If you select this option, you can make the same connecting cable even if you attach the attached parts yourselves.) The cable length between the connectors is 0.6 m. If you would like to purchase this cable individually, please consult your sales representative.

-LU1 : USB Interface Board ^{*1}

Digital control is enabled through USB.

If you control plural TB via USB, please use them according to one of the following ways.

- Utilizing a USB hub between a PC and TB
- Connecting all TB which have optical I/F board serially
- Connecting all TB serially ; the first TB is optical I/F board type, and all TB after the 2nd are standard I/F board type.

OS for Personal Computers : Microsoft Windows Xp / Vista / 7 / 8

Both of 32 bits and 64 bits are applicable

(Microsoft and Windows are registered trademark of Microsoft Corp. in USA and other.)

-LEt : LAN(Ethernet) Interface Board ^{*1}

Digital control is enabled through LAN (Ethernet).

If you control plural TB via Ethernet, please use them according to one of the following ways.

- Utilizing a hub between a PC and TB
- Connecting all TB which have optical I/F board serially
- Connecting all TB serially ; the first TB is optical I/F board type, and all TB after the 2nd are standard I/F board type.

-L(Mc0.5), -L(Mc0.15) : Change Communication Cable Length

Length of CO-M cable is to be 0.5 m and 0.15 m, respectively. (only either one is selectable.)

-LZ : Handle for carrying

The top panel has a handle for easy carrying, so height of TB becomes higher. [Added height] 360W models : 0.31" (8 mm), 720W models : 0.43" (11 mm), 1080W models : 0.39" (10 mm)

-LIc : Output current accumulation function ^{*2}

Accumulate the output current and display its value (up to +9999.999 Ah). The accumulated value is stored even when output is off. Because, the accumulated value which stop the output can be set preliminarily, it is very suitable to the application such as controlling plating solution.

*1 : These options can not be selected together.

Please refer to the catalogue of digital controller for power supplies "CO series" for the detail of digital interface function.

*2 : Please consider the location of usage. High humidity environment can be the cause of failure and corrosion.

How to Order

Please suffix above optional codes on the tail of Model number.

[Example] TB35V36A360W-LFsGoB(Fc10)IMsZ,
TB160V22A1080W-LEtFs(Mc0.5)MsZ (alphabetical order)

AC Input Cable

Contact nearby sales office in case of using TB series in European countries.

| CABLE TYPE 1 (Standard Attach. of 360W Models) | CABLE TYPE 8 (Standard Attach. of 720W Models) | CABLE TYPE 3 (Applicable 360W, 720W Models) | CABLE TYPE 4 (Applicable 360W, 720W Models) | CABLE TYPE 5 (Standard Attach. of 1080W Models) |
|---|---|--|--|--|
| 125 V / 10 A | 125 V / 15 A | 250 V / 10 A | 250 V / 10 A | 250 V / 25 A |
| | | | | |

Please use the AC input cable suitable for usage environment and the area. CABLE TYPE3 and 4 correspond to CE marking.

Example for Applied Actions

With TB series of the same model, output voltage and current can be increased by connecting power supplies in series or parallel. Control must be set on each individual unit. Do not connect together COMMON of 2 units or more as the COMMON of connector for remote control (TB1) is connected with output.

Series Operation

Sum of output is up to 250 V. It is impossible to series operation for one exceeds 250 V in output volt. Output current is of the min. one of power supply among them.

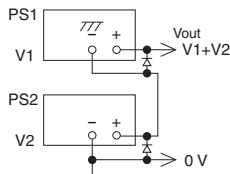

Parallel Operation

Make all setting voltage same value. Output current is sum of each current. In addition, make OVP level for all power supplies maximum to prevent damage.

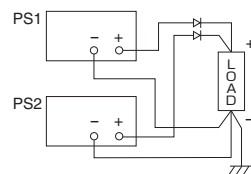

Split Operation

Possible to output on positive(+) or negative (-).

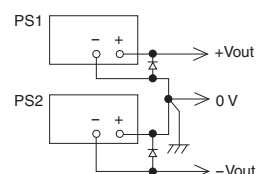

Technical Notes

Connection and Application Operation

■ Connection of Loads

- Connect short with leads of sufficient thickness.
- Use PVC wire (105 °C) which endure enough to applied voltage. Consideration of ampacity and limitation for lead wire length by sensing (0.5 V) requires for wiring to the load.

| AWG | mm ² | Max. current(A) |
|-----|-----------------|-----------------|
| 18 | 1.1 | 2 |
| 16 | 1.3 | 7 |
| 14 | 2.1 | 11 |
| 12 | 3.3 | 18 |
| 10 | 5.3 | 23 |
| 8 | 8.4 | 39 |
| 6 | 13 | 67 |
| 4 | 21 | 106 |
| 2 | 33 | 170 |
| 1 | 42 | 209 |
| 1/0 | 53 | 270 |
| 2/0 | 67 | 330 |
| 3/0 | 85 | 350 |

In case of 350 A and higher, use multi-cables or a copper bar.

■ Paralleling of Loads

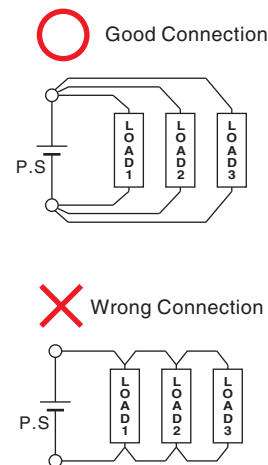

Conception of Specification

Unless other wise specified, specifications on this catalogue are of values at max. rated output (full scale*) after 2 hours warming-up.

Applied range of specifications

Ripple, Stability, Variations and Temp. coefficient are applied "F.S x Catalogue Value" and Linearity of output, Linearity of monitor, Linearity of indications are applied "F.S x value of ±0.5 % (*)" at the applied range of 10 % to 100 % of maximum rated output.

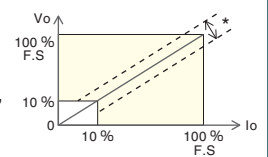

Ripple

Indication is in rms including high-frequency noise.

Preset

Preset value does not indicate exactly actual output state. If require exact setting, set voltage value by making actually output in no-load. For current, set current value by making gradually current rise in shorted terminals of output.

▶ Please Read Surely

When Select DC power Supplies

- Products on this catalogue are manufactured on consideration for safety fully as direct current power supplies, but please observe the Instruction Manual for operation and earth always grounding terminals for safety.
- Products on this catalogue are manufactured under the premise that applied on ground potential or in the range of series operation. Please consult our sales staff when use them on high potential floating.
- Products on this catalogue are manufactured on consideration for protection against electric discharge from loads fully, but when use them for some of continuous discharge like as spattering or for special withstand voltage test, please consult our sales staff in advance.
- We recommend contact our sales staff and inform them your requirement prior to your selection in order to secure safety as power supply equipment and make your best fit selection.

